

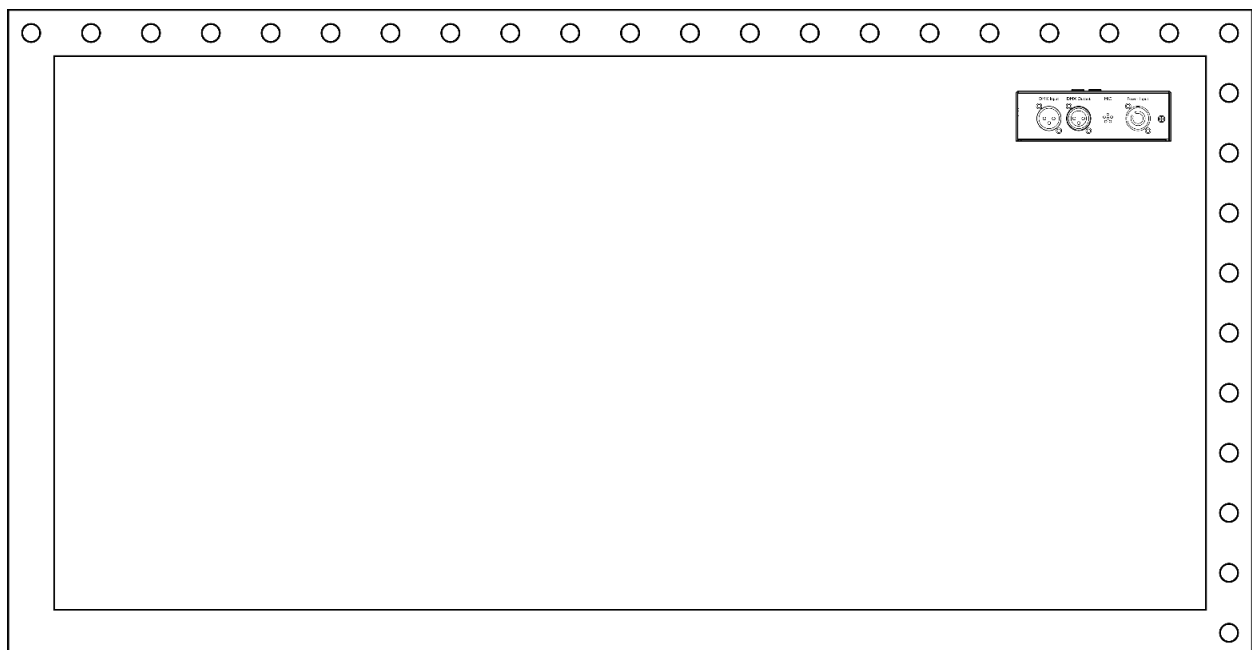

MANUAL



ENGLISH

Star Dream 6x3m 128 LED RGB V1

Ordercode: 40429

Table of contents

Warning	2
Safety Instructions	2
Operating Determinations	4
Rigging	4
Connection with the mains	6
Return Procedure	7
Claims	7
Description of the device	8
Overview	9
Controller	10
Installation	10
Setup and Operation	10
Control Modes	11
One Star Dream (Static colors and Built-in programs)	11
One Star Dream (Sound-controlled)	11
Multiple Star Dreams (Master/Slave control)	11
Multiple Star Dreams (DMX Control)	12
Fixture Linking	13
Data Cabling	13
Control Panel	14
Control Mode	14
DMX Addressing	14
Menu Overview	15
Main Menu Options	16
1. DMX Settings	17
1.1. Address	17
1.2. Channel	17
2. Static Colors	18
3. Built-in Programs	19
4. Sound-controlled Programs	20
5. Advanced Settings	21
5.1. Playback	21
5.2. Display	22
5.3. DMX Fail	22
5.4. Key Lock	22
5.5. Factory Reset	23
5.6. RGB or White	23
6. System Information	24
DMX Channels	24
7 channels	24
28 channels	25
Maintenance	27
Troubleshooting	27
No Light	27
No Response to DMX	27
Product Specifications	29
Dimensions	30

Warning



**For your own safety, please read this user manual carefully
before your initial start-up!**



Unpacking Instructions

Immediately upon receiving this product, carefully unpack the carton and check the contents to ensure that all parts are present, and have been received in good condition. Notify the dealer immediately and retain packing material for inspection if any parts appear damaged from shipping or the carton itself shows signs of mishandling. Save the carton and all packing materials. In the event that a fixture must be returned to the factory, it is important that the fixture be returned in the original factory box and packing.

Your shipment includes:

- Showtec Star Dream LED curtain controller
- Pro power cable (1,5 m)
- 1 x curtain 6x3m with 128 RGB LEDs
- User manual



LED Expected Lifespan

LEDs gradually decline in brightness over time. HEAT is the dominant factor that leads to the acceleration of this decline. Packaged in clusters, LEDs exhibit higher operating temperatures than in ideal or singular optimum conditions. For this reason, when all color LEDs are used at their fullest intensity, life of the LEDs is significantly reduced. If improving the lifespan is of higher priority, place care in providing for lower operational temperatures. This may include climatic-environmental and the reduction of overall projection intensity.



CAUTION!
Keep this device away from rain and moisture!
Unplug mains lead before opening the housing!



Safety Instructions

Every person involved with the installation, operation and maintenance of this device has to:

- be qualified
- follow the instructions of this manual



CAUTION! Be careful with your operations.
**With a dangerous voltage you can suffer
a dangerous electric shock when touching the wires!**



Before the initial start-up, please make sure that there is no damage caused by transportation. Should there be any, consult your dealer and do not use the device.

To maintain perfect condition and to ensure a safe operation, it is absolutely necessary for the user to follow the safety instructions and warning notes contained in this manual.

Please consider that damages caused by manual modifications to the device are not subject to warranty.

This device contains no user-serviceable parts. Refer servicing to qualified technicians only.

IMPORTANT:

The manufacturer will not accept liability for any resulting damages caused by the non-observance of this manual or any unauthorized modification to the device.

- Never let the power cord come into contact with other cables! Handle the power cord and all connections with the mains with particular caution!
- Never remove warning or informative labels from the unit.
- Never use anything to cover the ground contact.
- Never place any material over the LEDs.
- Never look directly into the light source.
- Never leave any cables lying around.
- Never use the device during thunderstorms, unplug the device immediately.
- Never leave various parts of the packaging (plastic bags, polystyrene foam, nails, etc.) within children's reach, as they are potential sources of danger.
- Do not connect this device to a dimmer pack.
- Do not switch the device on and off in short intervals, as this will reduce the device's life.
- Do not touch the device's housing bare-handed during its operation (housing becomes very hot). Allow the fixture to cool for at least 5 minutes before handling.
- Do not shake the device. Avoid brute force when installing or operating the device.
- Only use the device indoors, avoid contact with water or other liquids.
- Only operate the device after having checked if the housing is firmly closed and all screws are tightly fastened.
- Only operate the device after having familiarized with its functions.
- Avoid flames and do not put close to flammable liquids or gases.
- Always keep the case closed while operating.
- Always allow a free air space of at least 50 cm around the unit for ventilation.
- Always disconnect power from the mains, when device is not used or before cleaning! Only handle the power cord holding it by the plug. Never pull out the plug by tugging the power cord.
- Make sure that the device is not exposed to extreme heat, moisture or dust.
- Make sure that the available voltage is not higher than stated on the rear panel.
- Make sure that the power cord is never crimped or damaged. Check the device and the power cord from time to time.
- If the LEDs are obviously damaged, they need to be replaced, to prevent their functions from being impaired.
- If device was dropped or struck, disconnect mains power supply immediately. Have a qualified engineer inspect for safety before operating.
- If the device has been exposed to drastic temperature fluctuation (e.g. after transportation), do not switch it on immediately. The arising condensation water might damage your device. Leave the device switched off until it has reached room temperature.
- If your Showtec device fails to work properly, discontinue the use immediately. Pack the unit securely (preferably in the original packing material), and return it to your Showtec dealer for service.
- For adult use only. The fixture must be installed beyond the reach of children. Never leave the unit running unattended.
- Never attempt to bypass the thermostatic switch or fuses.
- The user is responsible for correct positioning and operating of the Star Dream. The manufacturer will not accept liability for damages caused by the misuse or incorrect installation of this device.
- This device falls under protection class I. Therefore it is essential to connect the yellow/green conductor to earth.

- Repairs, servicing and electric connection must be carried out by a qualified technician.
- WARRANTY: Till one year after date of purchase.

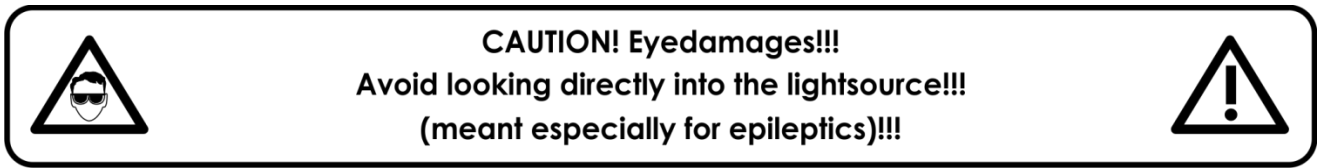

Operating Determinations

- This device is not designed for permanent operation. Consistent operation breaks will ensure that the device will serve you for a long time without defects.
- The minimum distance between light output and the illuminated surface must be bigger than 0,1 meter.
- The maximum ambient temperature $t_a = 45\text{ °C}$ must never be exceeded.
- In order to eliminate wear and improve the device's lifespan, during periods of non-use, completely disconnect from power source via breaker or by unplugging.
- The relative humidity must not exceed 50 % with an ambient temperature of 45 °C.
- If this device is operated in any other way than the one described in this manual, the product may suffer damages and the warranty becomes void.
- Any other operation may lead to dangers like short-circuit, burns, electric shock, crash, etc.

You endanger your own safety and the safety of others!

Rigging

Please follow the European and national guidelines concerning rigging, trussing and all other safety issues.

Do not attempt the installation yourself !

Always let the installation be carried out by an authorized dealer !

Procedure:

- If the Star Dream is lowered from the ceiling or high joists, professional trussing systems have to be used.
- Use the textile hook and loop fastener strips (Velcro) or shock cords to install the Star Dream.
- The controller must never be fixed swinging freely in the room.
- The installation must always be secured with a safety attachment, e.g. an appropriate safety net or safety cable.
- When rigging, derigging or servicing the Star Dream, always make sure, that the area below the installation site is secured and that there are not any unauthorized people around.

Star Dream Curtain

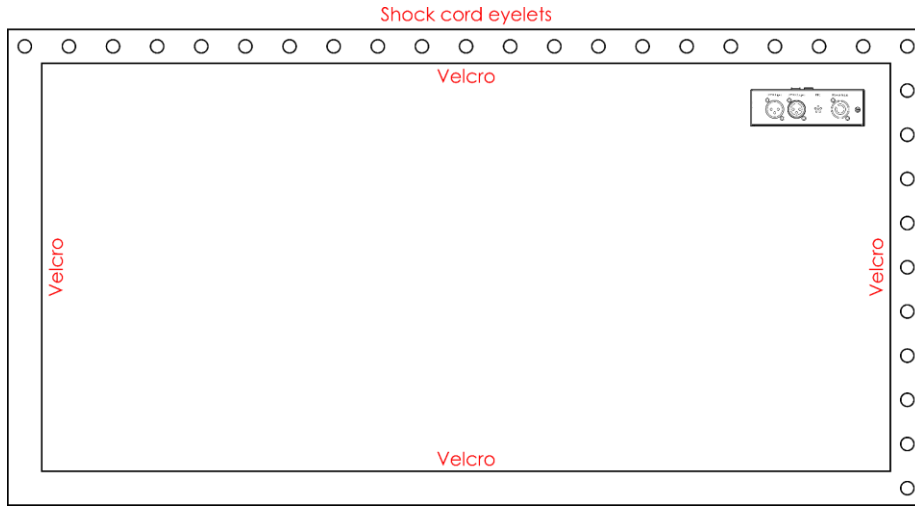

One Star Dream

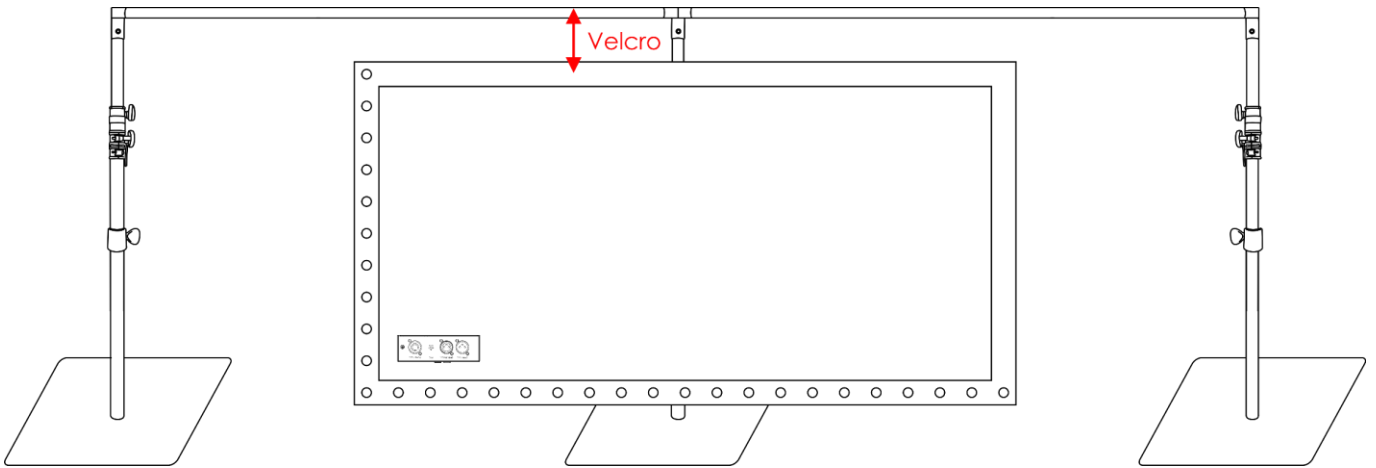

Multiple Star Dreams – Horizontal Installation

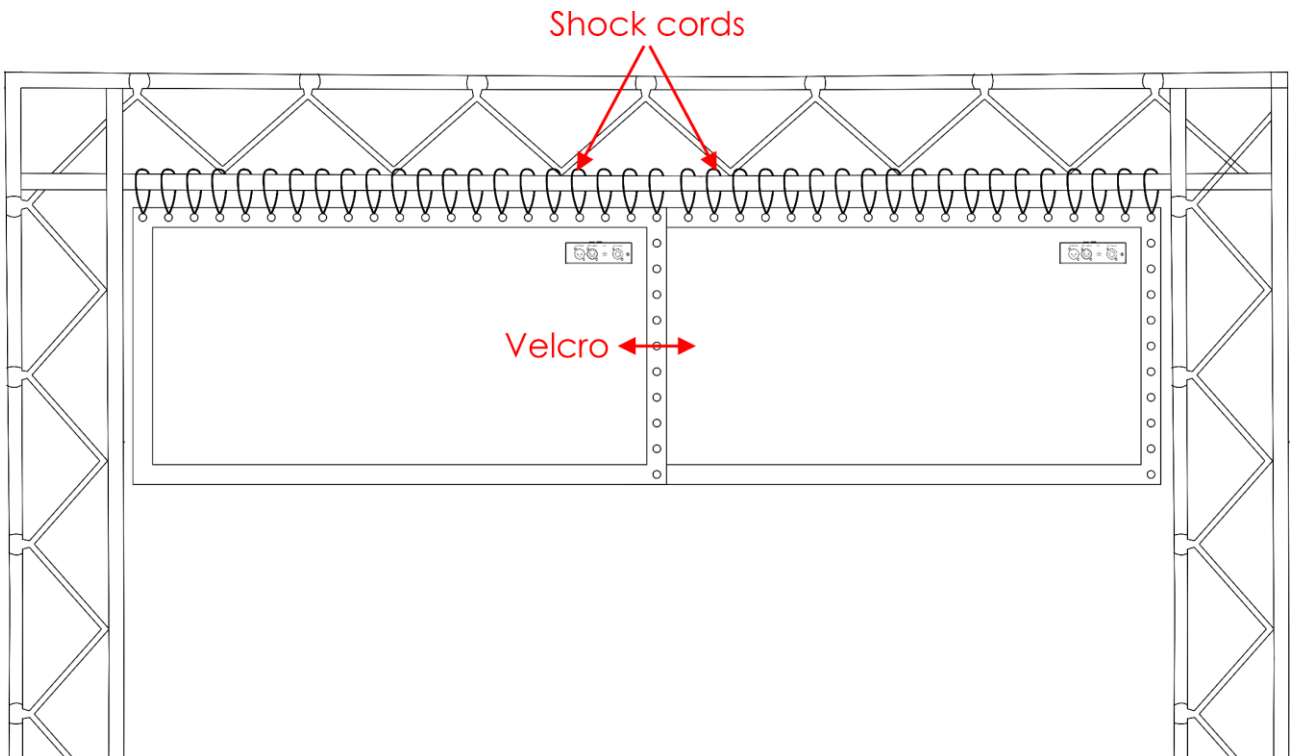

Multiple Star Dreams – Vertical Installation

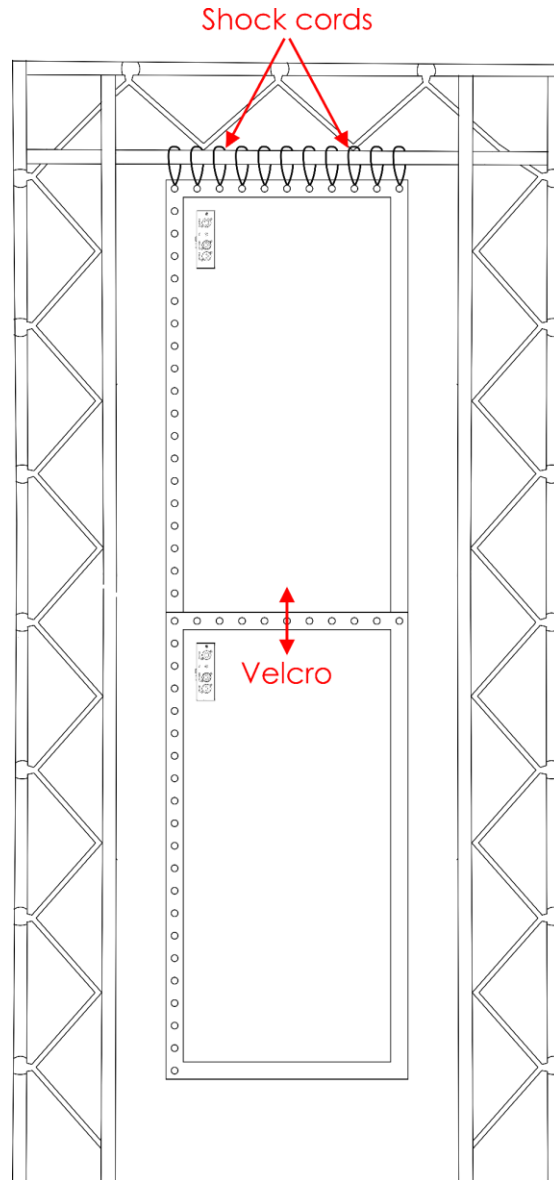

The Star Dream can be mounted to any kind of truss with hook and loop fasteners (Velcro) and/or shock cords.

Improper installation can cause serious injuries and/or damage of property!

Connection with the mains

Connect the device to the mains with the power-plug.
Always check if the right color cable is connected to the right place.

International	EU Cable	UK Cable	US Cable	Pin
L	BROWN	RED	YELLOW/COPPER	PHASE
N	BLUE	BLACK	SILVER	NEUTRAL
⊕	YELLOW/GREEN	GREEN	GREEN	PROTECTIVE GROUND

Make sure that the device is always properly connected to the earth!

Improper installation can cause serious injuries and/or damage of property!



Return Procedure

Returned merchandise must be sent prepaid and in the original packing, call tags will not be issued. Package must be clearly labeled with a Return Authorization Number (RMA number). Products returned without an RMA number will be refused. Highlite will not accept the returned goods or any responsibility. Call Highlite 0031-455667723 or mail offersales@highlite.com and request an RMA prior to shipping the fixture. Be prepared to provide the model number, serial number and a brief description of the cause for the return. Be sure to properly pack fixture, any shipping damage resulting from inadequate packaging is the customer's responsibility. Highlite reserves the right to use its own discretion to repair or replace product(s). As a suggestion, proper UPS packing or double-boxing is always a safe method to use.

Note: If you are given an RMA number, please include the following information on a piece of paper inside the box:

- 01) Your name.
- 02) Your address.
- 03) Your phone number.
- 04) A brief description of the symptoms.

Claims

The client has the obligation to check the delivered goods immediately upon delivery for any shortcomings and/or visible defects, or perform this check after our announcement that the goods are at their disposal. Damage incurred in shipping is the responsibility of the shipper; therefore the damage must be reported to the carrier upon receipt of merchandise.

It is the customer's responsibility to notify and submit claims with the shipper in the event that a fixture is damaged due to shipping. Transportation damage has to be reported to us within one day after receipt of the delivery.

Any return shipment has to be made post-paid at all times. Return shipments must be accompanied with a letter defining the reason for return shipment. Non-prepaid return shipments will be refused, unless otherwise agreed in writing.

Complaints against us must be made known in writing or by fax within 10 working days after receipt of the invoice. After this period complaints will not be handled anymore.

Complaints will only then be considered if the client has so far complied with all parts of the agreement, regardless of the agreement of which the obligation is resulting.

Description of the device

Features

The Star Dream 6x3m 128 LED RGB is a star curtain system with high output and great effects.

Curtain

- Light source: 128 x 5-mm RGB LED
- Data connector: 8 x curtain connectors
- Curtain: Heavy duty molton, flame-retardant in accordance with BS EN 1101:1996+A1:2006
- Assembly: Velcro and shock cords
- Curtain color: Black
- Dimensions: 6000 x 3000 mm (LxW)
- Weight: 11,5 kg

Controller

- Input voltage: 100–240V AC, 50/60 Hz
- Power consumption: 55 W
- Control: Static Colors, Built-in programs, Sound-controlled, Master/Slave, DMX
- Built-in programs: 10 programs + auto macro, with speed control
- Dimmer: 0–100 %
- Strobe: 0–25 Hz
- DMX channels: 7, 28 channels (RGB mode); 5, 12 channels (White mode)
- DMX connector: 3-pin XLR IN/OUT
- Data connector: 8 x curtain connectors OUT
- Color: Matt black
- Dimensions: 182 x 152 x 48 mm (LxWxH)
- Weight: 1,2 kg

Optional accessories

- [89300](#) – 3 x Baseplate
- [89310](#) – 3 x Baseplate pin
- [89331](#) – 3 x Telescopic upright – 3-way (180-420 cm)
- [89342](#) – 2 x Telescopic drape support
- [89090](#) – Showtec Shockcord (25 cm)

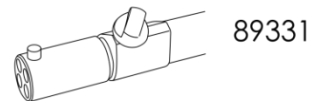
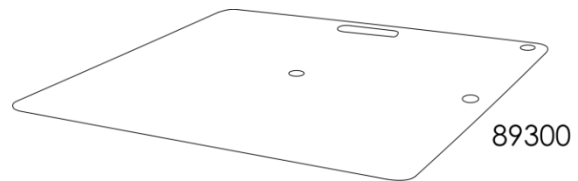

[D7422B](#) – DAP Stack Case 3

Overview

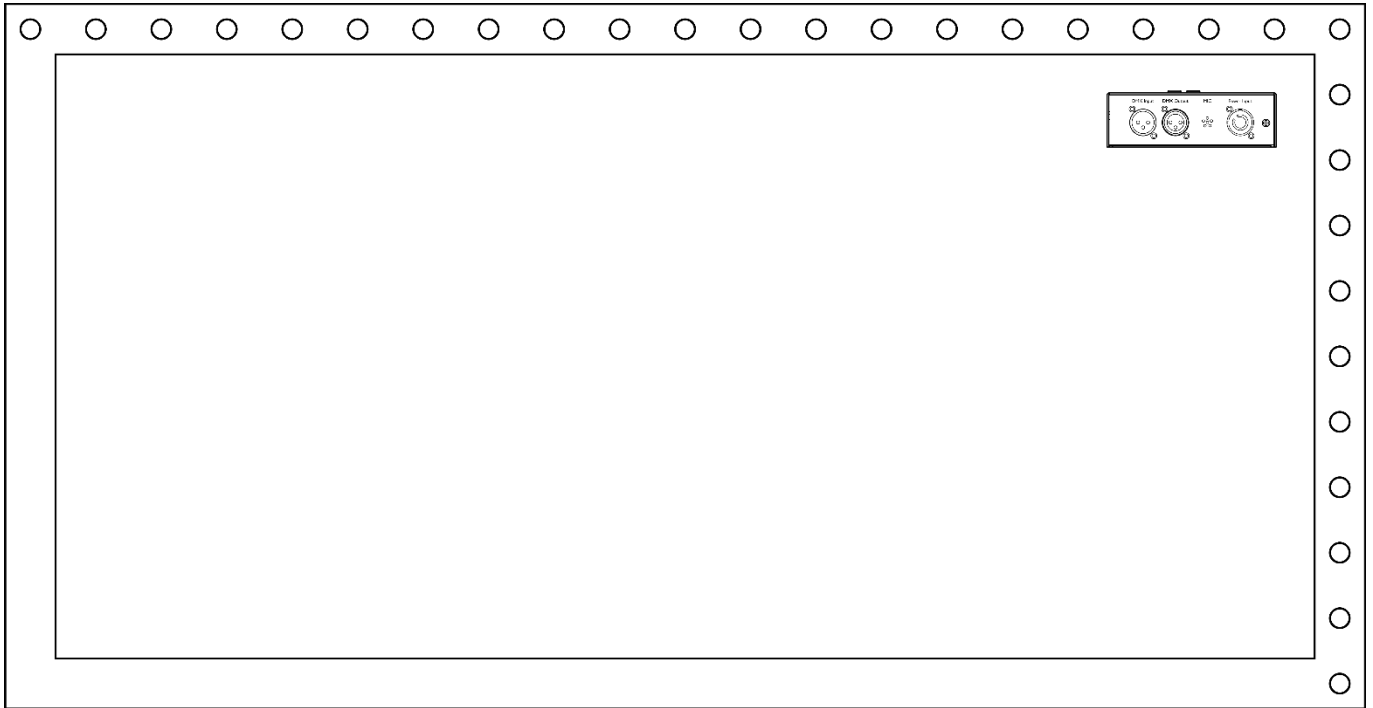

Fig. 01

Controller

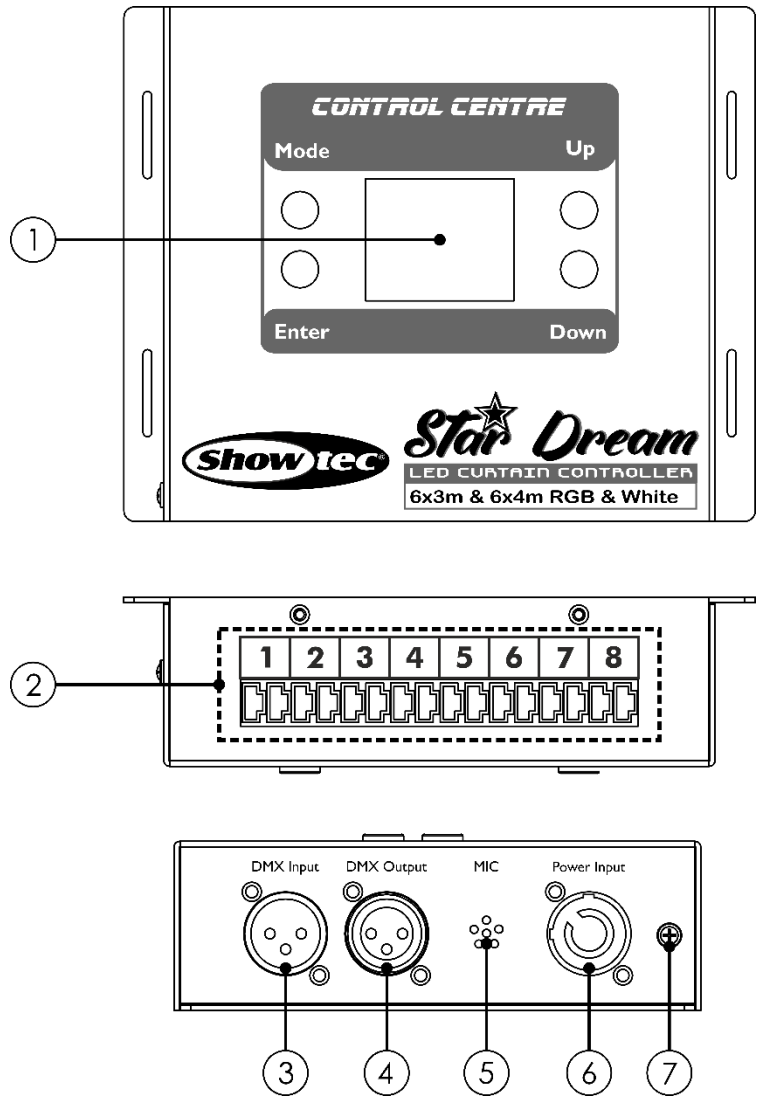

Fig. 02

- 01) LCD display + control buttons
- 02) Curtain connectors OUT
- 03) 3-pin DMX signal connector IN
- 04) 3-pin DMX signal connector OUT
- 05) Built-in microphone
- 06) 100–240 V pro power connector IN
- 07) Ground/earth connection

Installation

Remove all packing materials from the Star Dream 6x3m 128 LED RGB. Check if all foam and plastic padding is removed. Connect all cables.

Do not supply power before the whole system is set up and connected properly.
Always disconnect from electric mains power supply before cleaning or servicing.
Damages caused by non-observance are not subject to warranty.

Setup and Operation

Follow the directions below, as they pertain to your preferred operation mode.
 Before plugging the unit in, always make sure that the power supply matches the product specification voltage. Do not attempt to operate a 110V specification product on 230V power, or vice versa.
 Connect the device to the main power supply.

Control Modes

There are 5 modes:

- Static colors
- Built-in programs
- Sound-controlled
- Master/Slave
- DMX-512 (7CH, 28CH)

One Star Dream (Static colors and Built-in programs)

- 01) Fasten the effect light to a firm trussing. Leave at least 0,5 meter on all sides for air circulation.
- 02) Plug the end of the electric mains power cord into a proper electric power supply socket.
- 03) When the Star Dream is not connected with a DMX cable, it functions as a stand-alone device. Please see pages 18–19 for more information about Static colors and Built-in programs.

One Star Dream (Sound-controlled)

- 01) Fasten the effect light to a firm trussing. Leave at least 0,5 meter on all sides for air circulation.
- 02) Plug the end of the electric mains power cord into a proper electric power supply socket.
- 03) Turn on the music. If the device is set to sound-control, then the Star Dream will react to the beat of the music. Please see page 20 for more information about the sound-control options.

Multiple Star Dreams (Master/Slave control)

- 01) Fasten the effect light onto firm trussing. Leave at least 0,5 meter on all sides for air circulation.
- 02) Use a 3-pin XLR cable to connect the Star Dream.

The pins:



- 01) Earth
- 02) Signal -
- 03) Signal +

- 03) Link the units as shown in Fig. 03. Connect the first unit's DMX "out" socket with the second unit's "in" socket, using a DMX signal cable. Repeat this process to link the second, third, and fourth units. You can use the same functions on the master device as described on pages 18–20 (Static colors, Built-in programs or Sound-controlled mode). This means that you can set your desired operation mode on the master device and all slave devices will react the same as the master device. However, the master device should be set to MASTER mode and slave devices to STAND ALONE mode. See page 21 for more information.

Multiple Star Dreams (Master/Slave control)

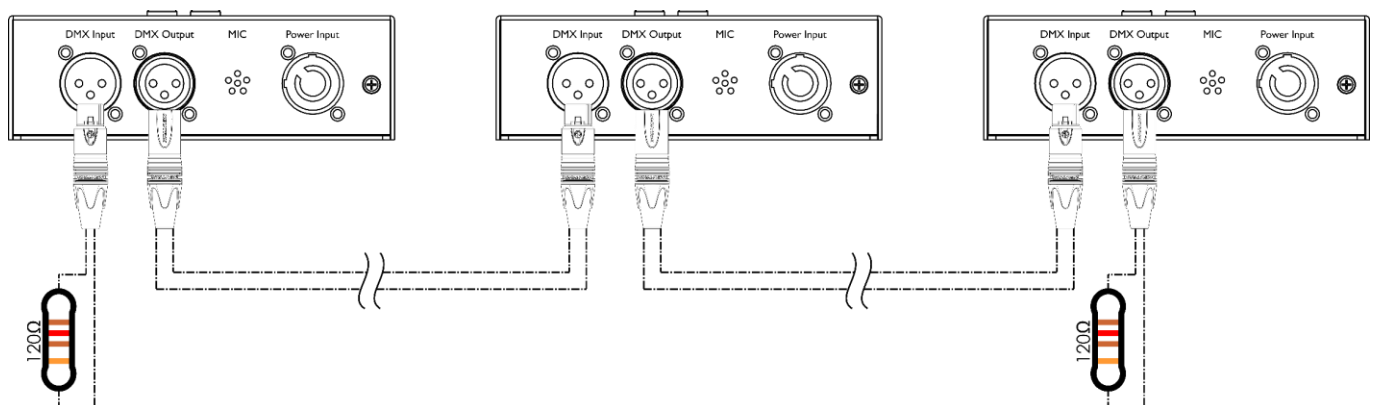
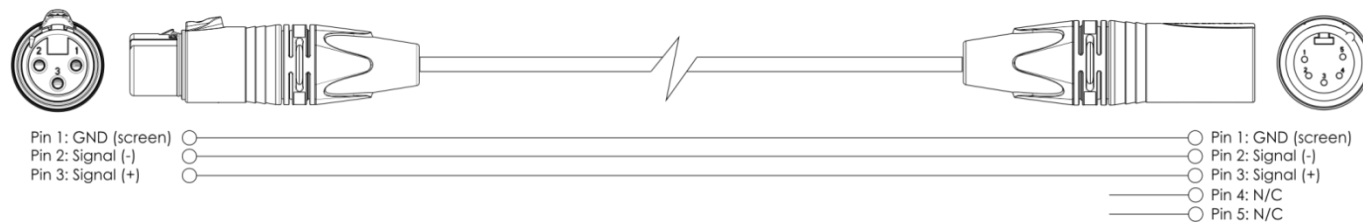
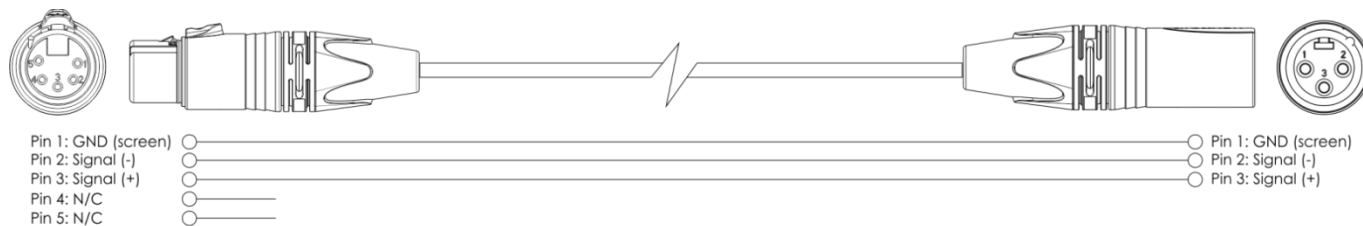

Fig. 03

Multiple Star Dreams (DMX Control)

- 01) Fasten the effect light to a firm trussing. Leave at least 0,5 meter on all sides for air circulation.
- 02) Always use a safety cable (ordercode 70140 / 70141).
- 03) Use a 3-pin XLR cable to connect the Star Dreams and other devices.



- 04) Link the units as shown in Fig. 04. Connect the first unit's DMX "out" socket with the second unit's "in" socket, using a DMX signal cable. Repeat this process to link the second, third, and fourth units.
- 05) Supply electric power: Plug electric mains power cords into each unit's pro power socket, then plug the other end of the mains power cord into proper electric power supply sockets, starting with the first unit. Do not supply power before the whole system is set up and connected properly.

Multiple Star Dreams DMX Setup

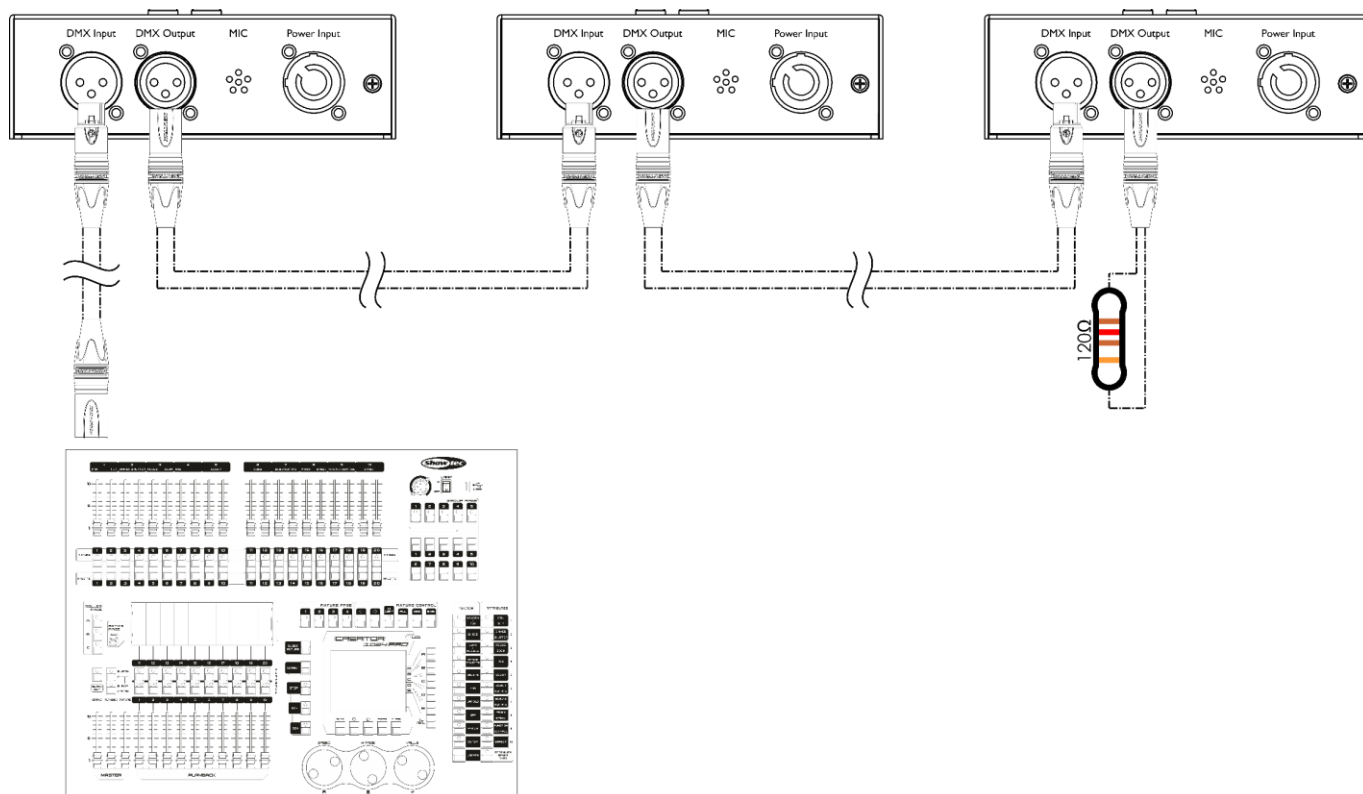



Fig. 04

Note : Link all cables before connecting electric power

Fixture Linking

You will need a serial data link to run light shows of one or more fixtures using a DMX-512 controller or to run synchronized shows of two or more fixtures set to a master/slave operating mode. The combined number of channels required by all the fixtures on a serial data link determines the number of fixtures the data link can support.

Important: Fixtures on a serial data link must be daisy-chained in a single line. To comply with the EIA-485 standard, no more than 30 devices should be connected on one data link. Connecting more than 30 fixtures on one serial data link without the use of a DMX optically isolated splitter may result in deterioration of the digital DMX signal.

 Maximum recommended DMX data link distance: 100 meters
Maximum recommended number of fixtures on a DMX data link: 30 fixtures
Maximum recommended number of fixtures on a power link @ 120V: 17 fixtures
Maximum recommended number of fixtures on a power link @ 230V: 35 fixtures

Data Cabling

To link fixtures together, you must obtain data cables. You can purchase DAP Audio certified DMX cables directly from a dealer/distributor or construct your own cable. If you choose to create your own cable, please use data-grade cables that can carry a high quality signal and are less prone to electromagnetic interference.

DAP Audio DMX Data Cables

- DAP Audio Basic microphone cable for allround use. bal. XLR/M 3-pin > XLR/F 3-pin. **Ordercode** FL01150 (1,5 m), FL013 (3 m), FL016 (6 m), FL0110 (10 m), FL0115 (15 m), FL0120 (20 m).
- DAP Audio X-type data cable XLR/M 3-pin > XLR/F 3-pin. **Ordercode** FLX0175 (0,75 m), FLX01150 (1,5 m), FLX013 (3 m), FLX016 (6 m), FLX0110 (10 m).
- DAP Audio cable for the demanding user with exceptional audio-qualities and connector made by Neutrik®. **Ordercode** FL71150 (1,5 m), FL713 (3 m), FL716 (6 m), FL7110 (10 m).
- DAP Audio cable for the demanding user with exceptional audio-qualities and connector made by Neutrik®. **Ordercode** FL7275 (0,75 m), FL72150 (1,5 m), FL723 (3 m), FL726 (6 m), FL7210 (10 m).
- DAP Audio 110 Ohm cable with digital signal transmission. **Ordercode** FL0975 (0,75 m), FL09150 (1,5 m), FL093 (3 m), FL096 (6 m), FL0910 (10 m), FL0915 (15 m), FL0920 (20 m).
- DAP Audio data cable FL08 DMX/AES-EBU, XLR/M 5-pin > XLR/F 5-pin. **Ordercode** FL08150 (1,5 m), FL083 (3 m), FL086 (6 m), FL0810 (10 m), FL0820 (20 m).
- DAP Audio DMX adapter: 5-pin/3-pin. **Ordercode** FLA29.
- DAP Audio DMX adapter: 3-pin/5-pin. **Ordercode** FLA30.
- DAP Audio DMX Terminator 3-pin. **Ordercode** FLA42.
- DAP Audio DMX Terminator 5-pin. **Ordercode** FLA43.

The Star Dream can be operated with a controller in **control mode** or without the controller in **stand-alone mode**.

Control Panel

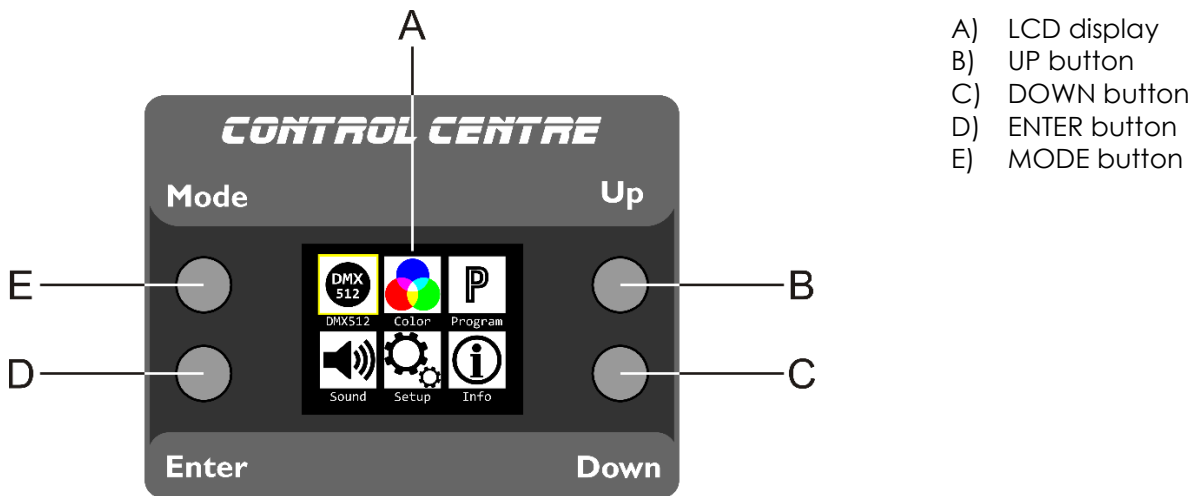

Fig. 05

Control Mode

The fixtures are individually addressed on a data-link and connected to the controller. The fixtures respond to the DMX signal from the controller. (When you select the DMX address and save it, the controller will display the saved DMX address, next time.)

DMX Addressing

The control panel on the front side of the base allows you to assign DMX fixture addresses, which is the first channel with which the Star Dream will respond to the controller. Please note, when you use the controller, the unit has **28** channels. When using multiple Star Dreams, make sure you set the DMX addresses right. Therefore, the DMX address of the first Star Dream should be **1(001)**; the DMX address of the second Star Dream should be **1+28=29 (029)**; the DMX address of the third Star Dream should be **29+28=57 (057)**, etc. Please, be sure that you do not have any overlapping channels in order to control each Star Dream correctly. If two or more Star Dreams are addressed similarly, they will work similarly.

Controlling:

After having addressed all Star Dream fixtures, you may now start operating these via your lighting controller.

Note: After switching on, the Star Dream will automatically detect whether DMX 512 data is received or not.

If there is no data received at the DMX-input, the "LED" on the control panel will not flash.

If not, the problem may be:

- The XLR cable from the controller is not connected with the input of the Star Dream.
- The controller is switched off or defective, the cable or connector is defective, or the signal wires are swapped in the input connector.

Note: It is necessary to insert an XLR termination plug (with 120 Ohm) in the last fixture in order to ensure proper transmission on the DMX data link.

⚠ Display Off after 10 seconds ⚠

When no button is pressed for 10 seconds, the display will turn off. To light up the display, you have to press the MODE button. Once you have pressed the button, the display will light up.

Menu Overview

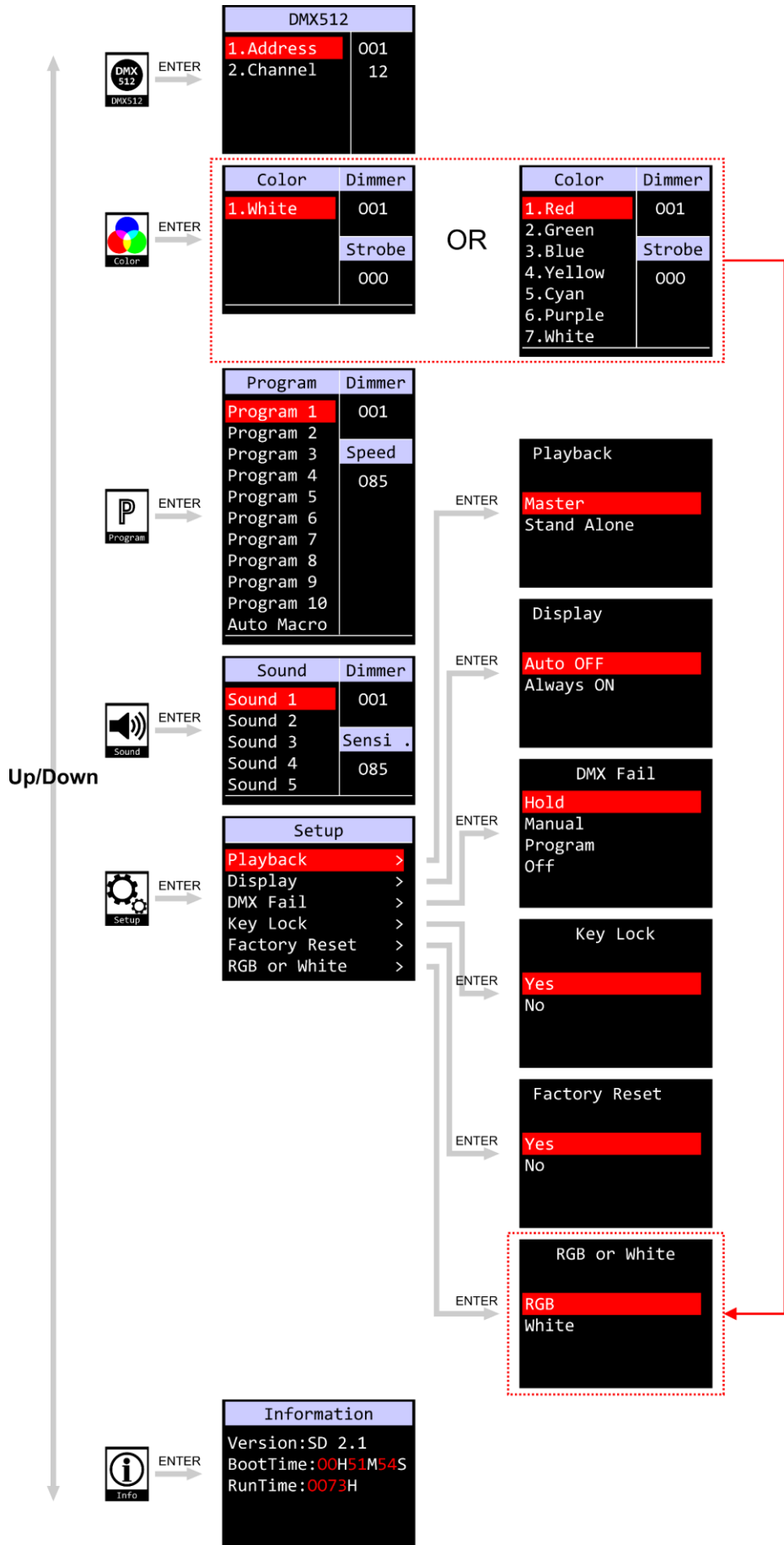

Main Menu Options



DMX settings



Static colors



Built-in programs



Sound-controlled programs

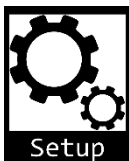

Advanced settings



System information

Upon start-up, the device will show its current color mode (RGB or White) as well as the currently active DMX channel mode.



1. DMX Settings

In this menu you can set the DMX address and choose the desired DMX channel mode.



- 01) While in the main menu, press the **UP/DOWN** buttons, until the display shows
- 02) Press the **ENTER** button to open the menu. The display will show:

DMX512	
1.Address	001
2.Channel	12

- 03) Press the **UP/DOWN** buttons to select one of the 2 options:
 - ADDRESS
 - CHANNEL
- 04) Press the **ENTER** button to open the menu.

1.1. Address

- 01) Press the **UP/DOWN** buttons to select the desired DMX starting address. The adjustment range is between 001–512.
- 02) Press the **ENTER** button to save changes.

1.2. Channel

- 01) Press the **UP/DOWN** buttons to select the desired DMX channel mode.
- 02) Press the **ENTER** button to save changes.

 **Please note that the selectable DMX channel modes depend on the currently active color mode (RGB or White).** 

Before you start programming, make sure that the device is in the appropriate color mode. See page 23 for more information about setting the color mode.

The available DMX channel modes are:

- In RGB mode: 7, 28 channels
- In White mode: 5, 12 channels

2. Static Colors

In this menu you can set the static colors.



In order to be able to operate the Star Dream in this mode, disconnect the DMX cable from the DMX input (03).



If you do not remove the cable, the light output will be blacked out.



- 01) While in the main menu, press the **UP/DOWN** buttons, until the display shows .
- 02) Press the **ENTER** button to open the menu. The display will show either of the 2 screens, depending on the current color mode setting (RGB or White):

RGB mode

Color	Dimmer
1.Red	001
2.Green	Strobe
3.Blue	
4.Yellow	000
5.Cyan	
6.Purple	
7.White	

White mode

Color	Dimmer
1.White	001
	Strobe
	000



Please note that the selectable static colors depend on the currently active color mode (RGB or White).



Before you start programming, make sure that the device is in the appropriate color mode. See page 23 for more information about setting the color mode.

- 03) Press the **UP/DOWN** buttons to select the desired static color (only in RGB mode).
- 04) Press the **ENTER** button to edit the color.
- 05) Press the **UP/DOWN** buttons to set the color brightness. The adjustment range is between 0–255, from dark to brightest.
- 06) Press the **ENTER** button again, to save changes and to proceed to strobe settings.
- 07) Press the **UP/DOWN** buttons to set the strobe frequency. The adjustment range is between 0–100, from OFF to high frequency.
- 08) Press the **ENTER** button to save changes.

3. Built-in Programs

In this menu you can run the built-in programs.



In order to be able to operate the Star Dream in this mode, disconnect the DMX cable from the DMX input (03).



If you do not remove the cable, the light output will be blacked out.



01) While in the main menu, press the **UP/DOWN** buttons until the display shows **Program**.

02) Press the **ENTER** button to open the menu. The display will show:

Program	Dimmer
Program 1	001
Program 2	
Program 3	Speed
Program 4	085
Program 5	
Program 6	
Program 7	
Program 8	
Program 9	
Program 10	
Auto Macro	

03) Press the **UP/DOWN** buttons to select one of the 10 built-in programs and the auto macro.

04) Press the **ENTER** button to edit the program.

05) Press the **UP/DOWN** buttons to set the program brightness. The adjustment range is between 0–255, from dark to brightest.

06) Press the **ENTER** button again, to save changes and to proceed to program speed settings.

07) Press the **UP/DOWN** buttons to set the program speed. The adjustment range is between 0–100, from slow to fast.

08) Press the **ENTER** button to save changes.

4. Sound-controlled Programs

In this menu you can run the sound-controlled programs.



In order to be able to operate the Star Dream in this mode, disconnect the DMX cable from the DMX input (03).



If you do not remove the cable, the light output will be blacked out.



01) While in the main menu, press the **UP/DOWN** buttons until the display shows **Sound**.

02) Press the **ENTER** button to open the menu. The display will show:

Sound	Dimmer
Sound 1	001
Sound 2	
Sound 3	Sensi .
Sound 4	085
Sound 5	

03) Press the **UP/DOWN** buttons to select one of the 5 sound-controlled programs.

04) Press the **ENTER** button to edit the program.

05) Press the **UP/DOWN** buttons to set the program brightness. The adjustment range is between 0–255, from dark to brightest.

06) Press the **ENTER** button again, to save changes and to proceed to sound sensitivity settings.

07) Press the **UP/DOWN** buttons to set the sound sensitivity. The adjustment range is between 0–100, from low to high sound sensitivity.

08) Press the **ENTER** button to save changes.

09) The device will now react to the beat of the background music by means of the built-in microphone.

5. Advanced Settings

In this menu you can adjust the device's settings.



- 01) While in the main menu, press the **UP/DOWN** buttons until the display shows
- 02) Press the **ENTER** button to open the menu. The display will show:

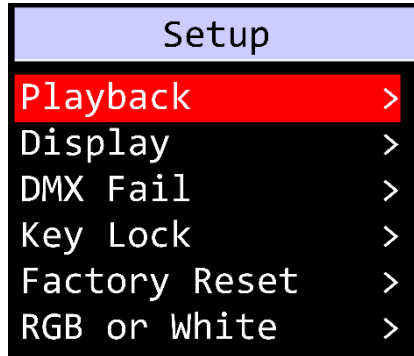

- 03) Press the **UP/DOWN** buttons to select one of the 6 options:
 - PLAYBACK
 - DISPLAY
 - DMX FAIL
 - KEY LOCK
 - FACTORY RESET
 - RGB OR WHITE

- 04) Press the **ENTER** button to open the menu.

5.1. Playback

In this menu you can set the desired operation mode.

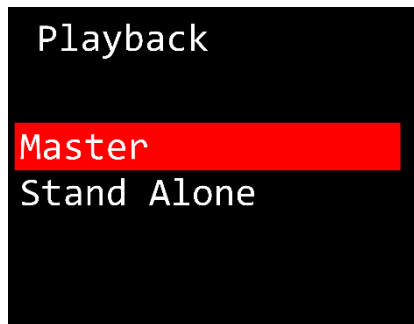

- 01) Press the **UP/DOWN** buttons to select one of the 2 options:
 - MASTER: Activate this option only on the master device in Master/Slave mode.
 - STAND ALONE: The recommended operation mode.
- 02) Press the **ENTER** button to confirm.

5.2. Display

In this menu you can set the display settings.

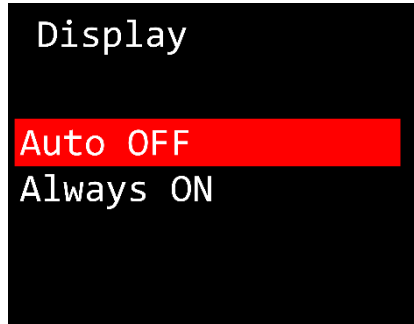

- 01) Press the **UP/DOWN** buttons to select one of the 2 options:
 - **AUTO OFF:** If no button is pressed, the display will turn off after 10 seconds.
 - **ALWAYS ON:** The display will remain continuously on.
- 02) Press the **ENTER** button to confirm.

5.3. DMX Fail

In this menu you can set the behavior of the device in case of a DMX signal error.

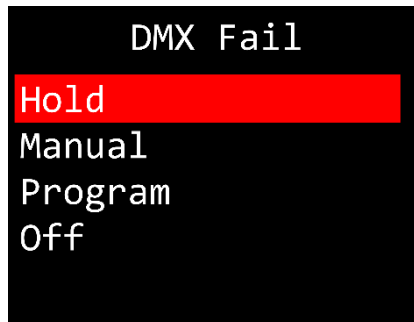

- 01) Press the **UP/DOWN** buttons to select one of the 4 options:
 - **HOLD:** The device will use last properly received DMX signal, ensuring uninterrupted performance.
 - **MANUAL:** The device will switch to Manual mode.
 - **PROGRAM:** The device will run the built-in programs.
 - **OFF:** The device will black out the light output.
- 02) Press the **ENTER** button to confirm.

5.4. Key Lock

In this menu you can set the safety lock, restricting access to the main menu.



- 01) Press the **UP/DOWN** buttons to select one of the 2 options:
 - **YES:** If no button is pressed within 10 seconds, the device's main menu will be locked.
In order to unlock it, press simultaneously the MODE and ENTER buttons.
 - **NO:** Safety lock is inactive.
- 02) Press the **ENTER** button to confirm.

5.5. Factory Reset

In this menu you can restore the default factory settings.

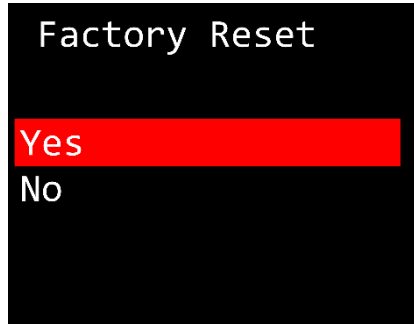

- 01) Press the **UP/DOWN** buttons to select YES or NO.
- 02) Press the **ENTER** button to confirm. If you have chosen YES, the default factory settings will be restored.



If you have restored the default factory settings, the default color mode will be RGB.



If you use the curtain equipped with white LEDs, always set the color mode back to WHITE. Otherwise, the Star Dream will not work properly.

See page 23 for more information about setting the color mode.

5.6. RGB or White

In this menu you can set the desired color mode (RGB or White). Your choice will have influence on the DMX channel modes and the device's functionalities. Before you start programming, make sure that the device is in the appropriate color mode. See page 17 for more information about the DMX channel modes.

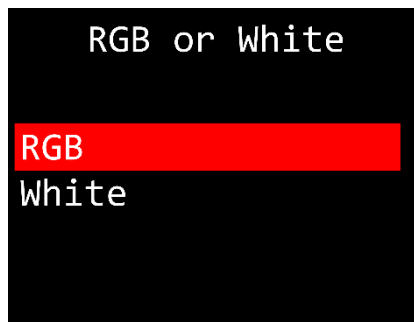

- 01) Press the **UP/DOWN** buttons to select one of the 2 options:
 - RGB: Select this mode **only** if you use the curtain equipped with **RGB LEDs**.
 - WHITE: Select this mode **only** if you use the curtain equipped with **white LEDs**.
- 02) Press the **ENTER** button to confirm.

6. System Information

In this menu you can view the current software version, the Boot Time (time since last start-up) and Run Time (total operation time).



- 01) While in the main menu, press the **UP/DOWN** buttons until the display shows
- 02) Press the **ENTER** button to open the menu.

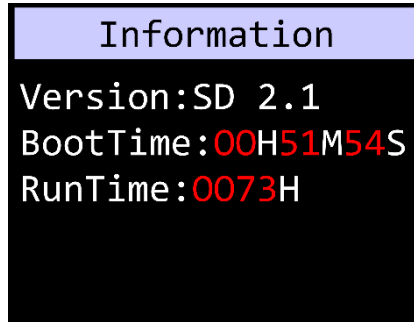

DMX Channels

7 channels

Channel 1 – Dimmer

0–255 Dimmer intensity, from dark to brightest

Channel 2 – Strobe CH1 must be open; CH3 and CH5–7 must be open

0–9 Not functional

10–255 Strobe flash frequency, from low to high frequency

Channel 3 – Programs CH1 must be open

0–49 Manual mode ON

50–59 Manual mode OFF

60–69 Red

70–79 Green

80–89 Blue

90–99 Yellow

100–109 Cyan

110–119 Purple

120–129 White

130–139 Program 1

140–149 Program 2

150–159 Program 3

160–169 Program 4

170–179 Program 5

180–189 Program 6

190–199 Program 7

200–209 Program 8

210–219 Program 9

220–229 Program 10

230–239 Auto macro

240–249 Sound-controlled mode

250–255 Not functional

Channel 4 – Program speed ⚠️ **CH3 must be set between 130–239** ⚠️
 0–255 Program speed, from slow to fast

Channel 4 – Sound sensitivity ⚠️ **CH3 must be set between 240–249** ⚠️
 0–255 Sound sensitivity, from OFF to high sound sensitivity

Channel 5 – Red, LED groups 1–8 ⚠️ **CH1 must be open; CH3 must be set between 0–49** ⚠️
 0–255 Gradual adjustment Red, from dark to brightest

Channel 6 – Green, LED groups 1–8 ⚠️ **CH1 must be open; CH3 must be set between 0–49** ⚠️
 0–255 Gradual adjustment Green, from dark to brightest

Channel 7 – Blue, LED groups 1–8 ⚠️ **CH1 must be open; CH3 must be set between 0–49** ⚠️
 0–255 Gradual adjustment Blue, from dark to brightest

28 channels

Channel 1 – Dimmer
 0–255 Dimmer intensity, from dark to brightest

Channel 2 – Strobe ⚠️ **CH1 must be open; CH3 and CH5–28 must be open** ⚠️
 0–9 Not functional
 10–255 Strobe flash frequency, from low to high frequency

Channel 3 – Programs ⚠️ **CH1 must be open** ⚠️
 0–49 Manual mode ON
 50–59 Manual mode OFF
 60–69 Red
 70–79 Green
 80–89 Blue
 90–99 Yellow
 100–109 Cyan
 110–119 Purple
 120–129 White
 130–139 Program 1
 140–149 Program 2
 150–159 Program 3
 160–169 Program 4
 170–179 Program 5
 180–189 Program 6
 190–199 Program 7
 200–209 Program 8
 210–219 Program 9
 220–229 Program 10
 230–239 Auto macro
 240–249 Sound-controlled mode
 250–255 Not functional

Channel 4 – Program speed ⚠️ **CH3 must be set between 130–239** ⚠️
 0–255 Program speed, from slow to fast

Channel 4 – Sound sensitivity ⚠️ **CH3 must be set between 240–249** ⚠️
0–255 Sound sensitivity, from OFF to high sound sensitivity

Channel 5 – Red, LED group 1 ⚠️ **CH1 must be open; CH3 must be set between 0–49** ⚠️
0–255 Gradual adjustment Red, from dark to brightest

Channel 6 – Green, LED group 1 ⚠️ **CH1 must be open; CH3 must be set between 0–49** ⚠️
0–255 Gradual adjustment Green, from dark to brightest

Channel 7 – Blue, LED group 1 ⚠️ **CH1 must be open; CH3 must be set between 0–49** ⚠️
0–255 Gradual adjustment Blue, from dark to brightest

Channel 8 – Red, LED group 2 ⚠️ **CH1 must be open; CH3 must be set between 0–49** ⚠️
0–255 Gradual adjustment Red, from dark to brightest

Channel 9 – Green, LED group 2 ⚠️ **CH1 must be open; CH3 must be set between 0–49** ⚠️
0–255 Gradual adjustment Green, from dark to brightest

Channel 10 – Blue, LED group 2 ⚠️ **CH1 must be open; CH3 must be set between 0–49** ⚠️
0–255 Gradual adjustment Blue, from dark to brightest

-
-
-
-
-
-

Channel 26 – Red, LED group 8 ⚠️ **CH1 must be open; CH3 must be set between 0–49** ⚠️
0–255 Gradual adjustment Red, from dark to brightest

Channel 27 – Green, LED group 8 ⚠️ **CH1 must be open; CH3 must be set between 0–49** ⚠️
0–255 Gradual adjustment Green, from dark to brightest

Channel 28 – Blue, LED group 8 ⚠️ **CH1 must be open; CH3 must be set between 0–49** ⚠️
0–255 Gradual adjustment Blue, from dark to brightest

Maintenance

The operator has to make sure that safety-related and machine-technical installations are to be inspected by an expert after every year in the course of an acceptance test.

The operator has to make sure that safety-related and machine-technical installations are to be inspected by a skilled person once a year.

The following points have to be considered during the inspection:

- 01) All screws used for installing the device or parts of the device have to be tightly connected and must not be corroded.
- 02) There may not be any deformations on housings, fixations and installation spots.
- 03) Mechanically moving parts like axles, eyes and others may not show any traces of wearing.
- 04) The electric power supply cables must not show any damages or material fatigue.

The Star Dream 6x3m 128 LED RGB requires almost no maintenance. However, you should keep the controller clean. Otherwise, the fixture's light output will be significantly reduced. Disconnect the mains power supply, and then wipe the cover with a damp cloth. Do not immerse in liquid. Wipe LEDs clean with glass cleaner and a soft cloth. Do not use alcohol or solvents.

Please clean internal components once a year with a light brush and vacuum cleaner.

Keep connections clean. Disconnect electric power, and then wipe the DMX and audio connections with a damp cloth. Make sure connections are thoroughly dry before linking equipment or supplying electric power.

Troubleshooting

This troubleshooting guide is meant to help solve simple problems.

If a problem occurs, carry out the steps below in sequence until a solution is found. Once the unit operates properly, do not carry out following steps.

No Light

If the light effect does not operate properly, refer servicing to a technician.

Suspect three potential problem areas as: the power supply, the LEDs, the internal fuse.

- 01) Power supply. Check if the controller is plugged into an appropriate power supply.
- 02) The LEDs. Return the Star Dream to your Showtec dealer.
- 03) The internal fuse. Return the Star Dream to your Showtec dealer.
- 04) If all of the above appears to be O.K., plug the unit in again.
- 05) If you are unable to determine the cause of the problem, do not open the Star Dream, as this may damage the unit and the warranty will become void.
- 06) Return the device to your Showtec dealer.

No Response to DMX

Suspect the DMX cable or connectors, a controller malfunction, a light effect DMX card malfunction.

- 01) Check the DMX setting. Make sure that DMX addresses are correct.
- 02) Check the DMX cable: Unplug the unit; change the DMX cable; then reconnect to electrical power. Try your DMX control again.
- 03) Determine whether the controller or light effect is at fault. Does the controller operate properly with other DMX products? If not, take the controller in for repair. If so, take the DMX cable and the light effect to a qualified technician.

Problem	Probable cause(s)	Solution
One or more fixtures do not function at all.	No power to the fixture.	<ul style="list-style-type: none"> • Check if power is switched on and cables are plugged in.
	Internal fuse blown.	<ul style="list-style-type: none"> • Return the device to your Showtec dealer.
Fixtures reset correctly, but all respond erratically or not at all to the controller.	The controller is not connected.	<ul style="list-style-type: none"> • Connect controller.
	3-pin XLR Out of the controller does not match XLR In of the first fixture on the link (i.e. signal is reversed).	<ul style="list-style-type: none"> • Install a phase reversing cable between the controller and the first fixture on the link.
Fixtures reset correctly, but some respond erratically or not at all to the controller.	Poor data quality.	<ul style="list-style-type: none"> • Check data quality. If much lower than 100 percent, the problem may be a bad data link connection, poor quality or broken cables, missing termination plug, or a defective fixture disturbing the link.
	Bad data link connection.	<ul style="list-style-type: none"> • Inspect connections and cables. Correct poor connections. Repair or replace damaged cables.
	Data link not terminated with 120 Ohm termination plug.	<ul style="list-style-type: none"> • Insert termination plug in output jack of the last fixture on the link.
	Incorrect addressing of the fixtures.	<ul style="list-style-type: none"> • Check address setting.
	One of the fixtures is defective and disturbs data transmission on the link.	<ul style="list-style-type: none"> • Bypass one fixture at a time until normal operation is restored: unplug both connectors and connect them directly together. • Have the defective fixture serviced by a qualified technician.
	3-pin XLR Out on the fixtures does not match (pins 2 and 3 reversed).	<ul style="list-style-type: none"> • Install a phase-reversing cable between the fixtures or swap pin 2 and 3 in the fixture that behaves erratically .
No light or LEDs cut out intermittently.	Fixture is too hot.	<ul style="list-style-type: none"> • Allow the fixture to cool down. • Turn up the air conditioning.
	LEDs damaged.	<ul style="list-style-type: none"> • Disconnect the fixture and return it to your dealer.
	The power supply settings do not match local AC voltage and frequency.	<ul style="list-style-type: none"> • Disconnect fixture. Check settings and correct if necessary.

Product Specifications

Model:	Showtec Star Dream 6x3m 128 LED RGB
Input voltage:	100–240V AC, 50/60 Hz
Power consumption:	55 W
DMX linking:	30 pcs
Dimensions (curtain):	6000 x 3000 mm (LxW)
Weight (curtain):	11,5 kg
Dimensions (controller):	182 x 152 x 48 mm (LxWxH)
Weight (controller):	1,2 kg
Operating and Programming:	
Signal pin OUT:	Pin 1 (earth), pin 2 (-), pin 3 (+)
DMX mode:	7, 28 channels (RGB mode); 5, 12 channels (White mode)
Signal input:	3-pin DMX IN
Signal output:	3-pin DMX OUT
Electro-mechanical effects:	
Light source:	128 x 5-mm RGB LED
Dimmer:	0–100 %
Strobe:	0–25 Hz
Housing (controller):	Metal & flame-retardant plastic
DMX control:	via standard DMX-controller
Onboard:	LCD display for easy setup
Control:	Static Colors, Built-in programs, Sound-controlled, Master/Slave, DMX
Built-in programs:	10 programs + auto macro, with speed control
Connections:	Dedicated Schuko to pro power & data connector
Assembly:	Velcro and shock cords
Curtain:	Heavy duty molton, flame-retardant in accordance with BS EN 1101:1996+A1:2006
Curtain connectors:	8 x curtain connectors
Color (curtain):	Black
Color (controller):	Matt black
Max. ambient temperature t_a :	45 °C
Max. housing temperature t_B :	60 °C
Minimum distance:	
Minimum distance from flammable surfaces:	0,5 m
Minimum distance to lighted object:	0,1 m

Design and product specifications are subject to change without prior notice.



Website: www.Showtec.info
 Email: service@highlite.com

Dimensions

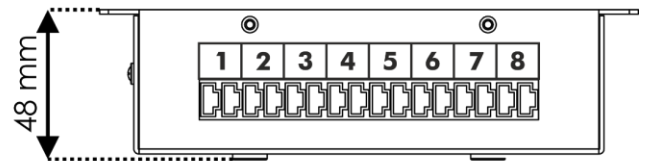
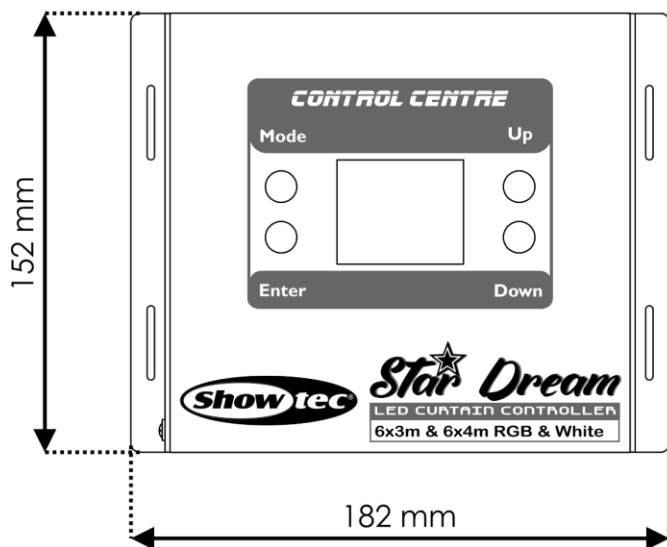
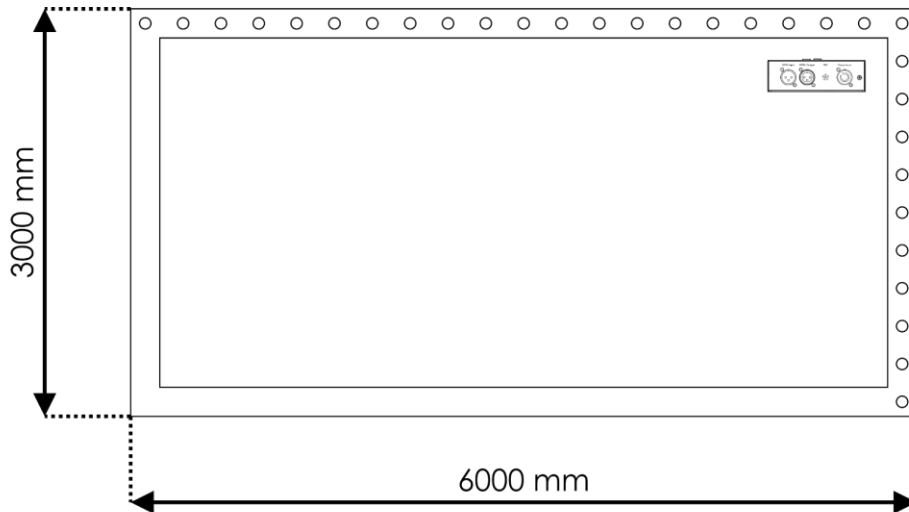



©2020 Showtec