

MDMX-24

Item ref: 154.100UK

24 Channel Mini DMX Controller

User Manual

Please read through this manual thoroughly before use, any damage caused by misuse of product will not be covered by warranty.



Easy to set up and use this 24-channel mini DMX controller is ideal for less experienced users or smaller functions and events. 2 bright and clear LED displays show both the channel number and value at the same time making the accurate control of fixtures a breeze. 6 channel sliders combine with a 4-way page selector and LED panel for simple range selection and a Blackout button is also included for fast shut off of fixtures when required.

In the box:

Your MDMX-24 should arrive with you in a single carton in good condition. The carton should contain 1 x main unit, 1 x UK power adaptor and 1 x user guide.

Controls Overview:

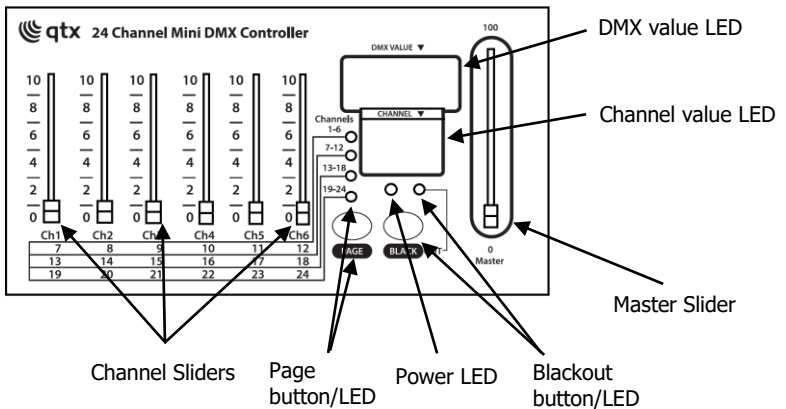

Operation:

1. Connect the power supply to the socket on the side of the unit and plug into a mains socket.
2. Connect a DMX lead to the socket on the side of the unit and a compatible DMX-512 device.
3. Switch on the controller using the red power switch on the side of the unit.
4. The controller will perform a self-test and the green Power LED will light up.
5. The startup status will be channels 1-6 which is indicated by the blue LED next to the relevant indicator.
6. Press the Page button to switch to pages 7-12, 13-18 or 19-24, again the blue LED indicator will inform you of the current page selection.
7. Use the channel sliders to adjust the DMX parameter value of the relevant channel. The DMX value LED will indicate the current DMX parameter value at any time.
8. The Channel LED will display the current slider being used (stays on last adjusted channel).
9. Use the Master slider to control the DMX parameter values of all channels (i.e set to zero all channels are closed).
10. Use the Blackout button to instantly switch all DMX parameters to zero.

Specifications:

DMX channels	24
Power supply	12Vdc, 500mA
Dimensions	210 x 100 x 50mm
Weight	762g



Please do not open cover, contains high voltage. This product is not serviceable or repairable by the end user. Please refer to qualified personnel for service and repair.



This product is classed as Electrical or Electronic equipment and should not be disposed with other household or commercial waste at the end of its useful life. The goods must be disposed of according to your local council guidelines.

Errors and omissions excepted.

Copyright© 2022 AVSL Group Ltd, Unit 2 Bridgewater Park,
Taylor Road, Trafford Park, Manchester. M41 7JQ.

AVSL (Europe) Ltd, Unit 3D North Point House,
North Point Bus. Park, New Mallow Road, Cork, Ireland.