

H Series

Video Wall Splicers



User Manual

Contents

1 Device Connections	1
1.1 Input Cards	1
1.2 Output Card	1
1.3 Power Supply	2
1.4 Control Card	3
1.5 Preview Card	3
2 Device Login	4
2.1 Power On/Off	4
2.2 Web Page Login	4
3 Screen Configuration.....	7
3.1 LED Screen	7
3.2 LCD Screen	9
4 Basic Operations.....	11
4.1 Add Layers.....	11
4.2 Add BKG	15
4.3 Add OSD.....	16
4.4 Set Presets	19
4.5 Set Preset Playbacks.....	21
4.6 Group Input Sources.....	23
4.7 Crop Input Sources.....	24
4.8 Set 3D Effect.....	25
4.9 Set Channel Logos	28
4.10 Set Reverse Control.....	30
4.11 Set Output Audio	32
4.12 Set Input and Output EDID	32
4.13 Control Backend Devices.....	34
4.14 Manage Roles.....	34
4.15 Manage Users	35
5 LCD Menu Introduction	38
5.1 Device.....	38
5.2 Multiviewer	39
5.3 Settings.....	39
5.3.1 Communication Settings	39
5.3.2 Firmware Version	40
5.3.3 Advanced Settings	41
5.4 Language.....	44
5.5 About Us	45
6 Web Introduction	46
6.1 Screen Configuration	46
6.2 Programming	50
6.3 Multiviewer	51
6.4 Device.....	52
6.5 Settings.....	59
6.5.1 EDID Management.....	59
6.5.2 IPC Management	60
6.5.2.1 Add IPC Signal	60
6.5.2.2 Import Multiple IPC Sources.....	64
6.5.2.3 Add IPC Mosaic Source	64
6.5.3 Permission Management	67

6.5.3.1 Role Management.....	67
6.5.3.2 User Management.....	67
6.5.4 Open API Management.....	67
6.5.5 Session Management	68
6.5.6 Backup Management	68
6.5.7 Log Management	70
6.5.7.1 Login Logs.....	70
6.5.7.2 Operation Logs.....	71
6.5.8 Communication Settings	72
6.5.8.1 IP Settings.....	72
6.5.8.2 Serial Port Settings.....	72
6.5.8.3 Set Serial Port Parameters.....	72
6.5.8.4 Add Commands.....	73
6.5.8.5 Edit Commands.....	74
6.5.8.6 Delete Commands.....	74
6.5.9 Firmware Update.....	75
6.5.10 Reset Settings.....	75
6.5.11 Other Settings	76
6.5.12 Help.....	78
6.5.13 About Us	78

1 Device Connections

1.1 Input Cards

The H series supports a variety of input sources. Connect the input sources to the matched input card connectors.

- DVI, HDMI, SDI, CVBS, VGA or DP input sources

Connect the input sources to the matched input card connectors using corresponding cables or converter cables.

- IP camera sources

Connect the input source to the Ethernet port of the H_2xRJ45 IP input card using an Ethernet cable.

Figure 1-1 Input card connection

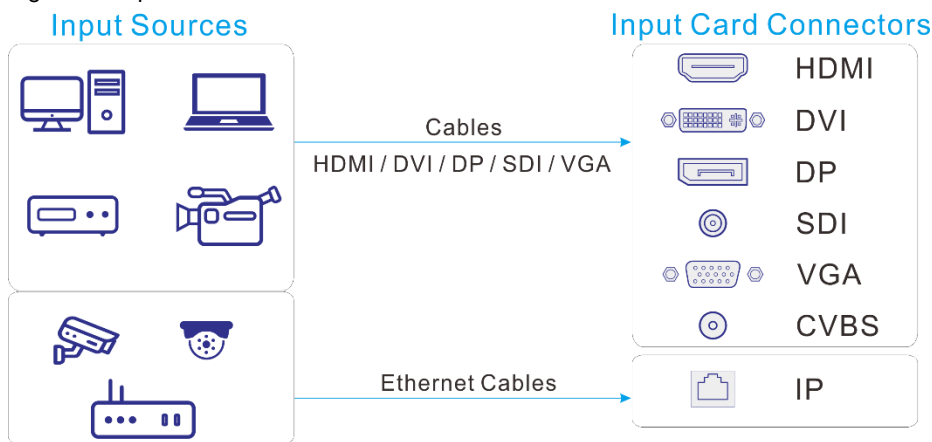

1.2 Output Card

The H series provides two kinds of LED 4K sending cards: H_16xRJ45+2xfiber sending card and H_20xRJ45 sending card.

- When the H_16xRJ45+2xfiber sending card is used for output, the OPT ports copy the outputs on the Ethernet ports. OPT 1 copies and outputs the data on Ethernet ports 1–8. OPT 2 copies and outputs the data on Ethernet ports 9–16.

- Via Ethernet port

Connect the Ethernet ports directly to the LED screen based on the screen structure.

- Via OPT port

OPT ports are used for long-distance transmission. Connect the OPT ports to a fiber converter firstly, and then connect the fiber converter to the LED screen.

Figure 1-2 LED 4K sending card connection

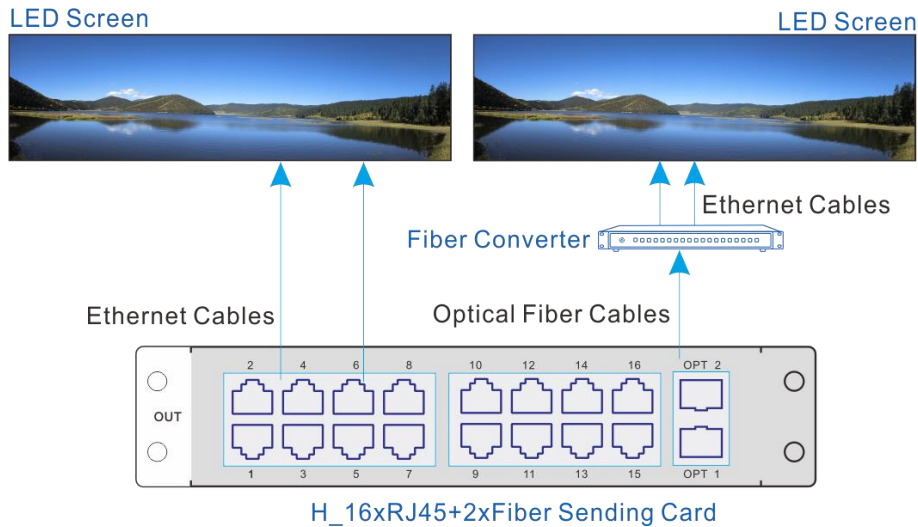

Note:

The H_20xRJ45 sending card is connected and configured in the same way as the H_16xRJ45+2xfiber sending card.

- When the video output card is used for output, the LED screen can be loaded by the sending device and the LCD screen can be loaded directly.
 - Via Ethernet cable

To load the LED screen, connect the output card connectors to the input connectors of the sending device, and connect the sending device to the LED screen via Ethernet cables, as well as configure the screen on the sending device.
 - Via video cable

To load the LCD screen, connect the output card connectors to input connectors of the LCD splicing screen via video cables.

Figure 1-3 Video output card connection

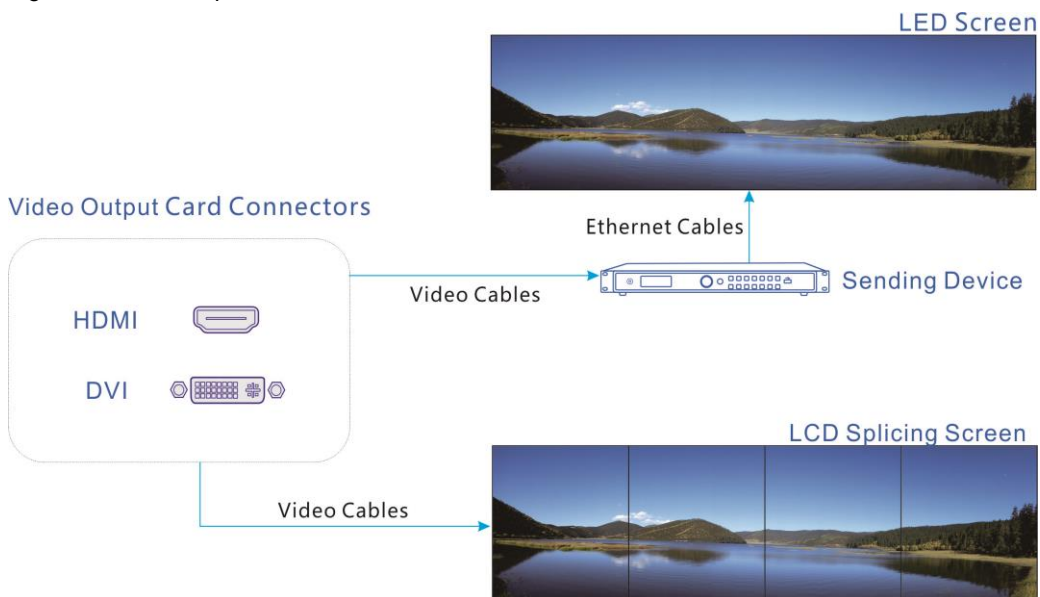

1.3 Power Supply

Connect the power connector on the rear panel to the electrical outlet using the supplied power cord.

1.4 Control Card

You can control the H series devices on a control PC through either of the following two methods.

- Method I: Direct control for single-user control
Connect the device Ethernet port to the control PC.
- Method II: Using a router or switch, for multiple user collaboration in a wired or wireless way
Connect the Ethernet ports of both the device and control PC to the router or switch.

Figure 1-4 Control card connection

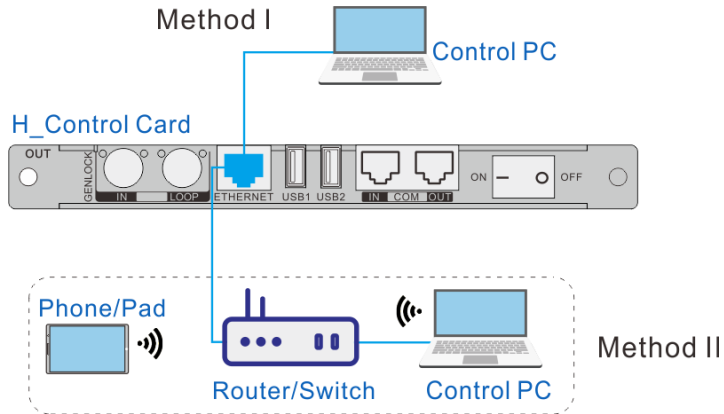

1.5 Preview Card

The H series allows you to monitor the inputs and outputs on a PC or monitor.

Figure 1-5 Preview card connection

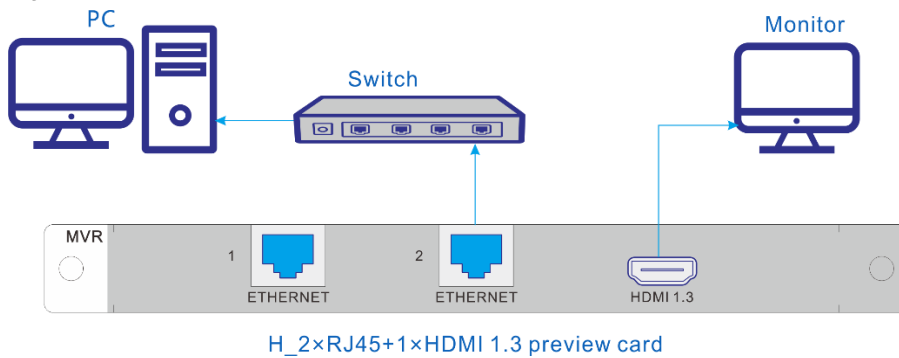

- Via Ethernet port:
Connect one of the Ethernet ports on the preview card and the Ethernet port of the control card to the same switch for the input source and screen monitoring on the Web page.
- Via HDMI connector:
Connect the HDMI connector of the preview card to a monitor for on-site monitoring.

2 Device Login

2.1 Power On/Off

The power switch is on the H_Control card.

Figure 2-1 Control card



- – / On: Power on the device.
- O / Off: Power off the device.

Power on

Connect the power cord, and then set the rocker switch to **ON**. The home screen is displayed as follows after successfully powered on.

The device IP address is displayed at the top right on the home screen. The default IP address is 192.168.0.10.

Figure 2-2 Home screen

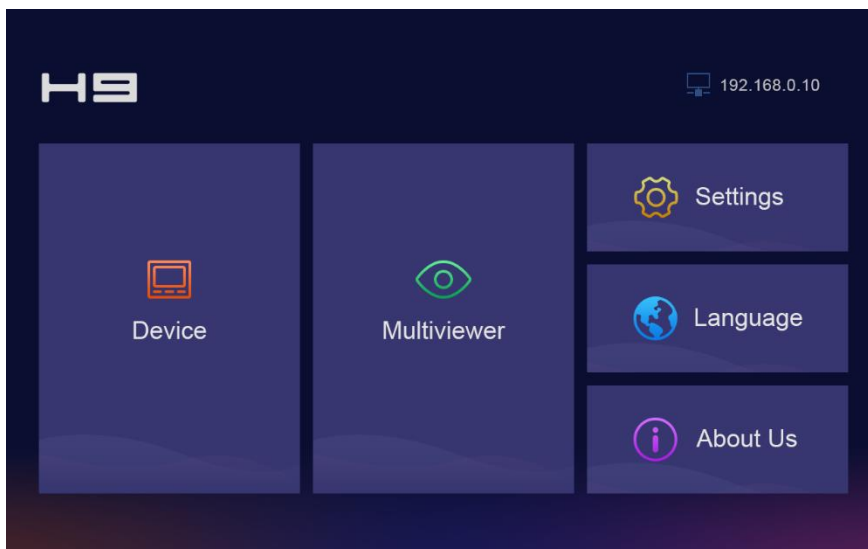

Power off

Set the rocker switch to **OFF**, and then disconnect the power cord if necessary.

2.2 Web Page Login

Prerequisites

- You have completed the connection as described in [1.4 Control Card](#).
- You have obtained the login user name and password. The default user name and password are "admin".

Notes

- When an H series device is connected directly to a control PC, the device and control PC must be on the same network segment and their IP addresses cannot conflict. For example, if the device IP address is 192.168.0.10, the IP address of the control PC must be 192.168.0.X and X cannot be 10.
- When an H series device is connected to a control PC using a router or switch, you must set to automatically get the IP address, and select **Obtain an IP address automatically** for the network settings on the control PC.
 - a. Go to **Settings > Communication** from the home screen to enter the network settings screen.
 - b. Click the **IP Settings** tab to enter the IP settings screen.
 - c. Set the mode to **Automatic**.
 - d. Click **Main** at the top left to return to the home screen and the current device IP address appears at the top right.
 - e. Select **Obtain an IP address automatically** on the Internet protocol properties window on the control PC. The router or switch will assign the IP addresses to the device and control PC automatically.

Operating Procedure

- Step 1 Open the suggested web browser on your computer, enter the device IP address in the address bar, and then press **Enter** to jump to the login interface for the Web page for the H series devices.

Figure 2-3 Web login page

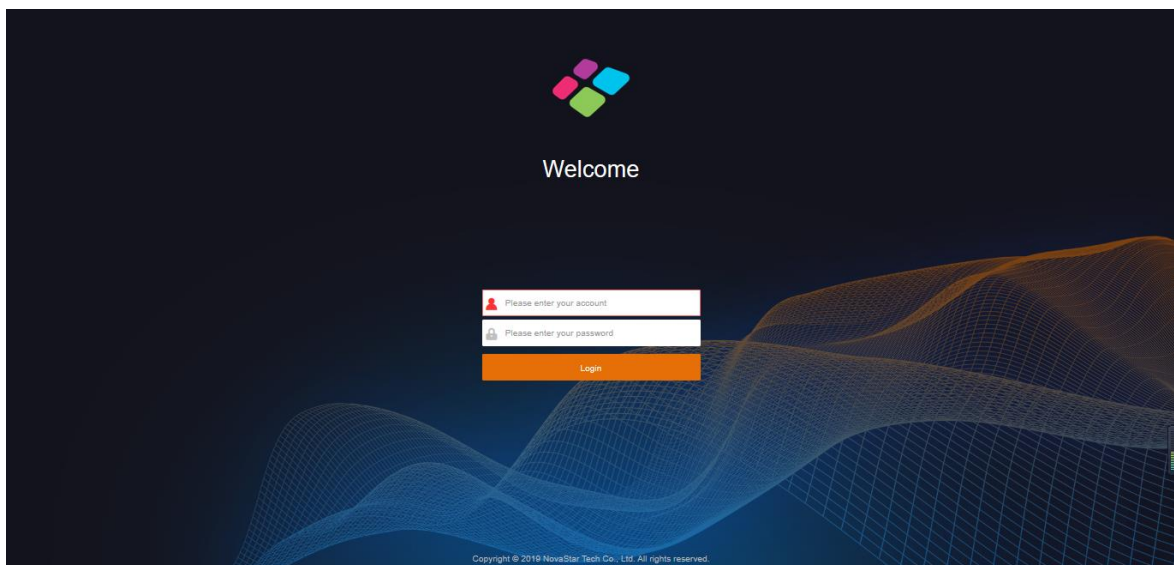

- Step 2 Enter the user name and password, and click **Login** to log in to the Web page.

The default user name and password are both "admin".

Figure 2-4 Web page after login

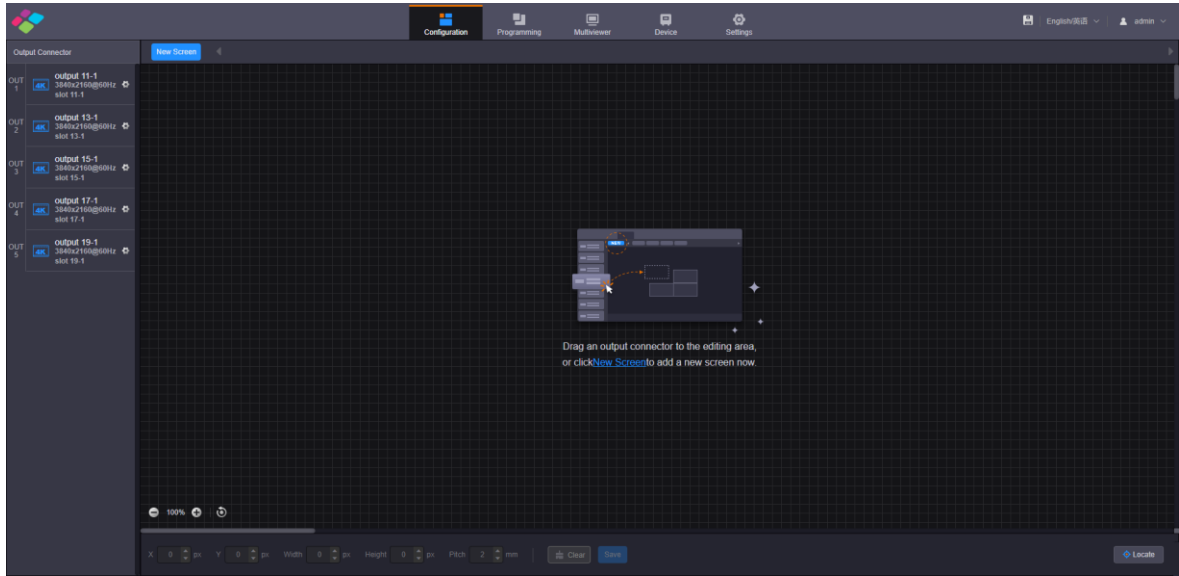

3 Screen Configuration

3.1 LED Screen



Configure the screen based on the structure and data flow of the screen loaded by the current device. Associating the screen with the outputs will make it convenient for you to control the screen by area.

When you use different output cards, the screen configuration methods are different.

- Method I:

Use the LED 4K sending cards (H_16xRJ45+2xfiber sending card and H_20xRJ45 sending card) for output, a virtual 4K connector is displayed on the configuration page.

Use the fiber sending card for output, a connector with the sender icon is displayed on the configuration page.

- For the H_16xRJ45+2xfiber sending card, an icon  is displayed.
- For the H_20xRJ45 sending card, an icon  is displayed.
- For the H_4xfiber sending card, an icon  is displayed.

Note:

The H_16xRJ45+2xfiber sending card and H_20xRJ45 sending card can be configured on the same screen when they have the same frame rate.

- Method II:

Use the DVI and HDMI output cards for output, note that only the connectors of the same type can be configured on the same screen.

Web Operations

- Step 1 Select **Configuration** to enter the screen configuration page.
- Step 2 Click **New Screen** at the top to open the **New Screen** window.

Figure 3-1 New screen

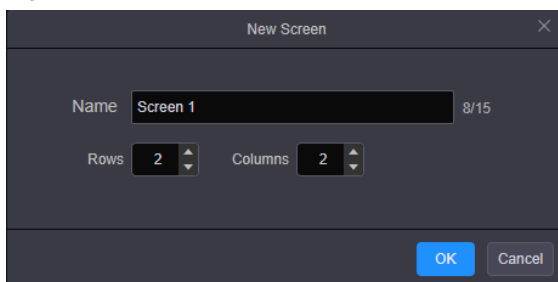

- Step 3 Enter a screen name. You can name the screen according to its location or input, which is easier for you to identify the screen quickly and precisely when operating the layers, presets and so on.
- Step 4 Set the quantities of the rows and columns based on the screen structure.
- Step 5 Select the desired output card to load the screen, and then click and drag the sending card to the screen.

Notes:

When you use the H_16xRJ45+2xfiber sending card or H_20xRJ45 sending card, it is recommended you go to **Settings > EDID Management > Output** to set the output resolution and frame rate first.

When you use the H_4xfiber sending card, go to the **Device** page to configure the connector working mode first, and then go to **Settings > EDID Management > Output** to set the output resolution and frame rate.

When you use the DVI or HDMI output card, the real connector is displayed on the **Configuration** page, such as DVI or HDMI.

Figure 3-2 LED screen configuration

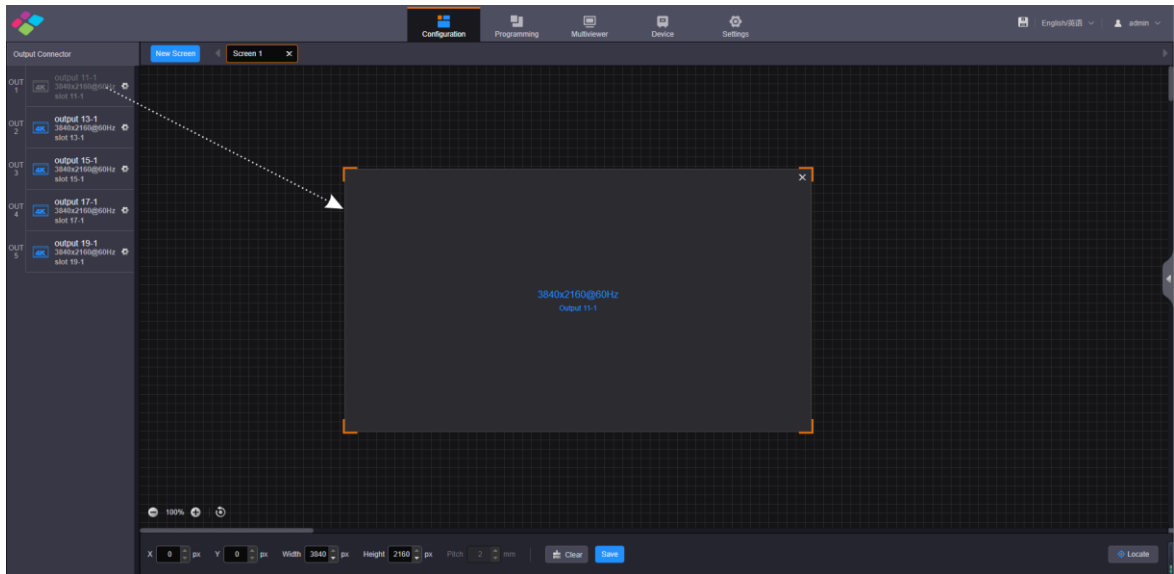

- Highlighted connector: The output connector is not used by the screen.
- Gray connector: The output connector is used by the screen and cannot be used repeatedly.

Step 6 Click **Save** to save the screen settings.

NovaLCT Operations

Note:

When the H_16xRJ45+2xfiber sending card, H_20xRJ45 sending card or H_4xfiber sending card is used, you must configure the screen in NovaLCT.

Step 1 Go to **User > Advanced Synchronous System User Login**. Enter the password and click **Login**. The default password is "admin".

Figure 3-3 NovaLCT (logged in)

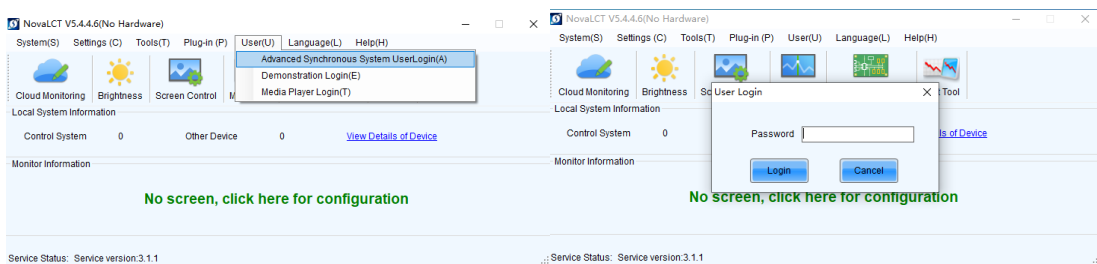

Step 2 On the menu bar, go to **Settings > Screen Configuration** to open the **Screen Configuration** window.

Step 3 Select a communication port and click **Next**.

Figure 3-4 Select a communication port

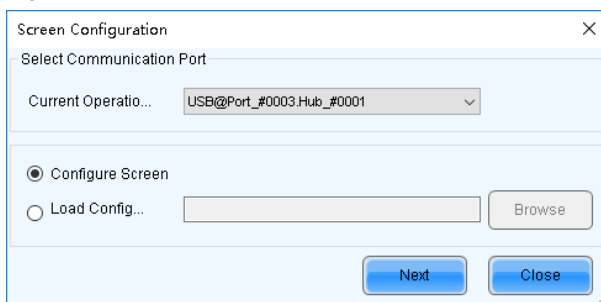

- Step 4 Select the **Sending Card** tab to select the desired input sources and click **Send**.
- Step 5 Select the **Screen Connection** tab to show the screen configuration settings.

Figure 3-5 Screen configuration

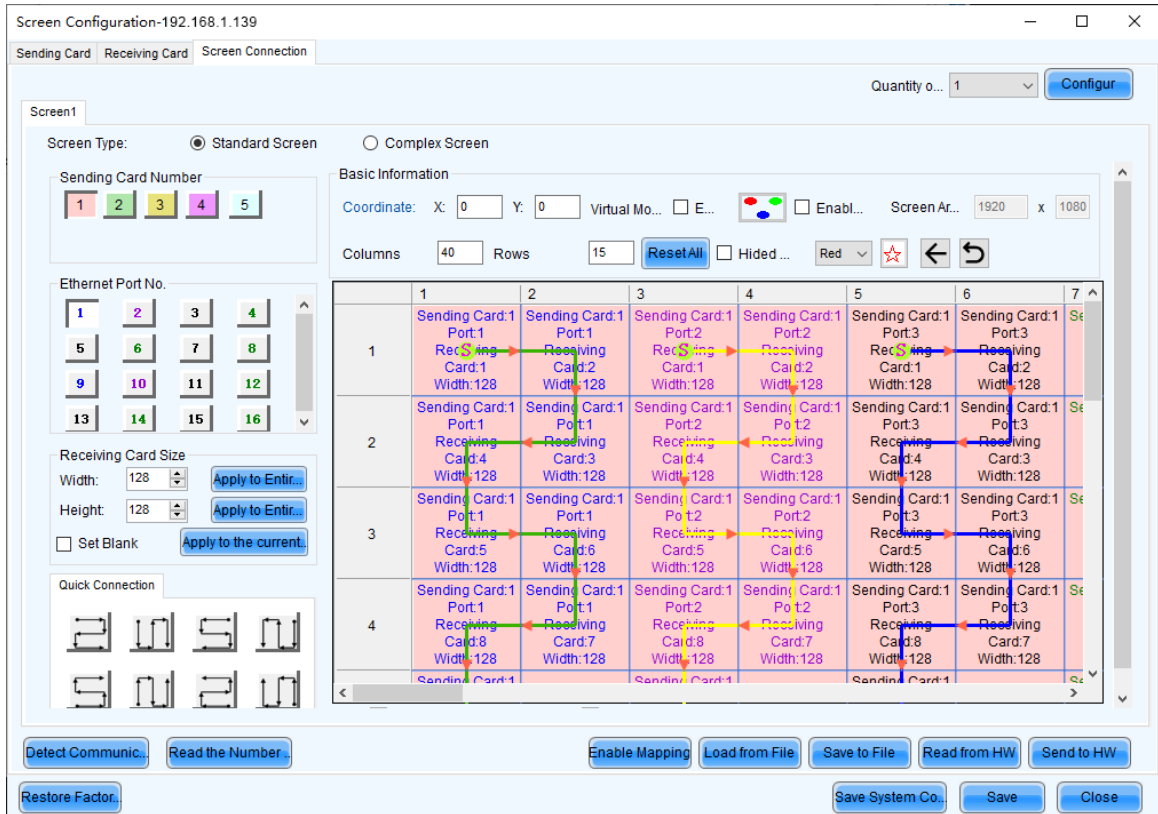

- Step 6 Click the drop-down arrow next to **Quantity o...** on the top right to set the screen quantity and then click **Configure**. You can also increase or decrease screen quantity here.
- Step 7 Select the sending card number which indicates the sequence number of the installed H_16xRJ45+2xfiber sending cards. The sending cards are numbered from left to right.
- Step 8 Set the column and row quantities of receiving cards, as well as the receiving card size (loading capacity) based on the current screen structure.
- Step 9 Select the Ethernet port number and draw lines between cabinets based on the cabinet connection and the connection mode between the device and screen.
- Step 10 After the settings, click **Send to HW** to complete the screen configuration.

Notes:

If some receiving cards are left blank, please cancel the connection of those cards according to on-site configuration.
 For configuration for irregular screens, please refer to the NovaLCT User Manual.
 For configuration for common and irregular screens, you can also use SmartLCT software from NovaStar. For detailed information, please refer to the SmartLCT User Manual.

3.2 LCD Screen

- Step 1 Select **Configuration** to enter the screen configuration page.
- Step 2 Click **New Screen** at the top to open the **New Screen** window.

Figure 3-6 New screen

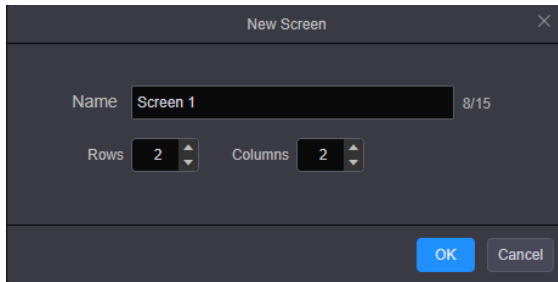

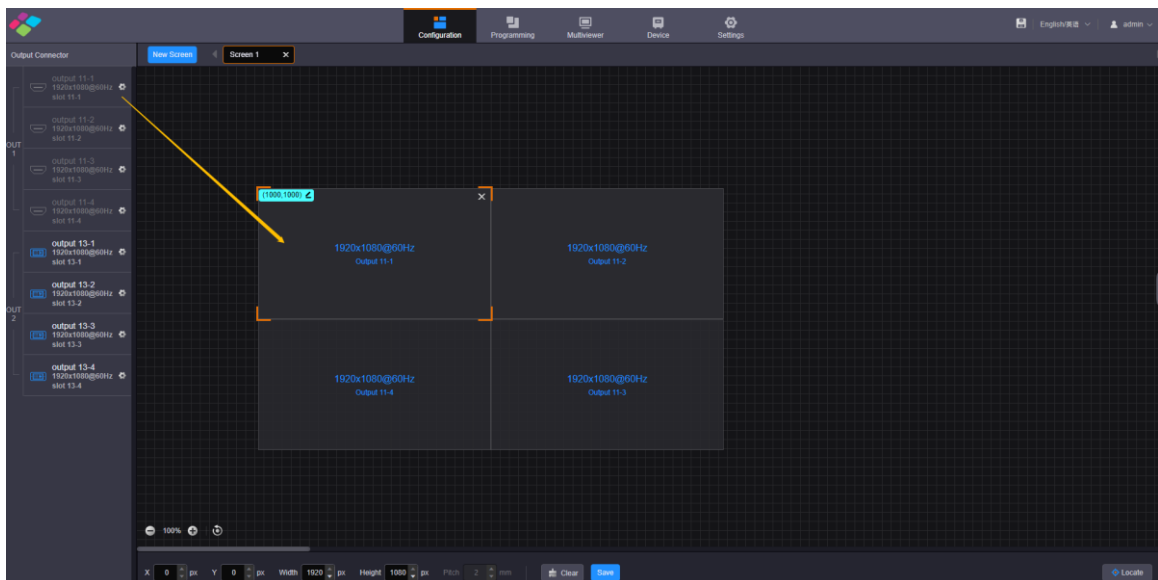

- Step 3 Enter a screen name. You can name the screen according to its location or input, which is easier for you to identify the screen quickly and precisely when operating the layers, presets and so on.
- Step 4 Set the quantities of the rows and columns based on the screen structure.
- Step 5 Select the desired output card to load the screen, and then click and drag the video output card to the screen.
- Step 6 Click **Save** to save the screen settings.

Figure 3-7 LCD screen configuration



Notes

On the screen configurations page, click **Locate** at the bottom right, and the location information appears on the loaded screen, which is easier for you to configure the screen.

For quickly locating the screen position in the editing area, select the loaded screen and click  at the top left next to the coordinates to enter the values of **X** and **Y**, and then click . The initial position is at the top left of the editing area.

- Step 7 Set the LCD bezel compensation.

1. Click  on the right edge to expand the screen properties pane.
2. Check the box in front of **LCD Bezel Compensation** to turn on the bezel compensation function.
3. Enter the values in the **H Spacing** and **V Spacing** text boxes based on the LCD edge width.

Note

When there is a spacing between two screens, the values of **H Spacing** and **V Spacing** are set to the edge width plus the half spacing. The unit is pixel.

4 Basic Operations

4.1 Add Layers

- Step 1 Click **Programming** to enter the layer editing page.
- Step 2 On top of the **Programming** page, select the screen that you will operate.
- Step 3 Click an input in the **Input Signal** area on the left and drag it to the editing area to add a layer.

Figure 4-1 Add layers

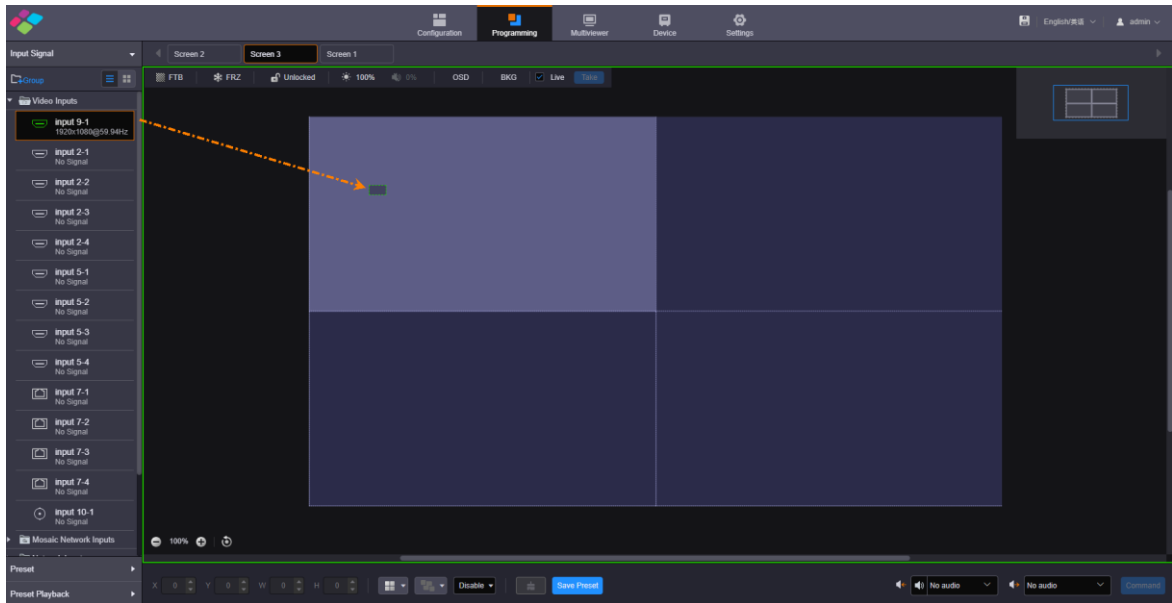







Note:

If you have grouped the input sources, you need to expand the group and drag the desired input source to the layer.

Adjust Layers

Click the layer and you can perform the following operations.

- Adjust the layer size.
 - Quick adjustment: Click the small square on the layer edge, and drag the square when the cursor turns to a double-sided arrow to quickly adjust the layer size.
 - Precise adjustment: Enter specific numbers in the **Width** and **Height** text boxes below the layer editing area to precisely adjust the layer size.
- Adjust the layer position.
 - Quick adjustment: Click and drag the layer to quickly move the layer.
 - Precise adjustment: Enter specific numbers in the X and Y text boxes below the layer editing area to precisely position the layer. The adjustment reference is the top left corner of the layer. If the X and Y values are both 0, the layer's top left corner locates at the top left corner of the screen.
- Lock or unlock the layer by clicking  or  at the top right corner of the layer.
- Freeze or unfreeze the layer image by clicking .
- Display or undisplay the layer playback on the Web page by clicking  / .
- When the IPC signal is used as the layer input source, click  at the top right corner of the layer to view the detailed decoding parameters and stream parameters.







- When there are multiple overlapping layers, you can adjust the layer priorities.
 - : Bring the selected layer to the front, and the layer image will be displayed completely.
 - : Send the selected layer to the back, and the layer will be partially covered by other overlapping layers.
 - : Bring the selected layer forward.
 - : Send the selected layer backward.
- Set whether to flip the layer image. Three options are provided as follows.
 - Disable: Do not flip the layer image.
 - : Flip the layer image horizontally.
 - : Flip the layer image vertically.
 - : Flip the layer image horizontally and vertically.

Figure 4-2 Layer flipping







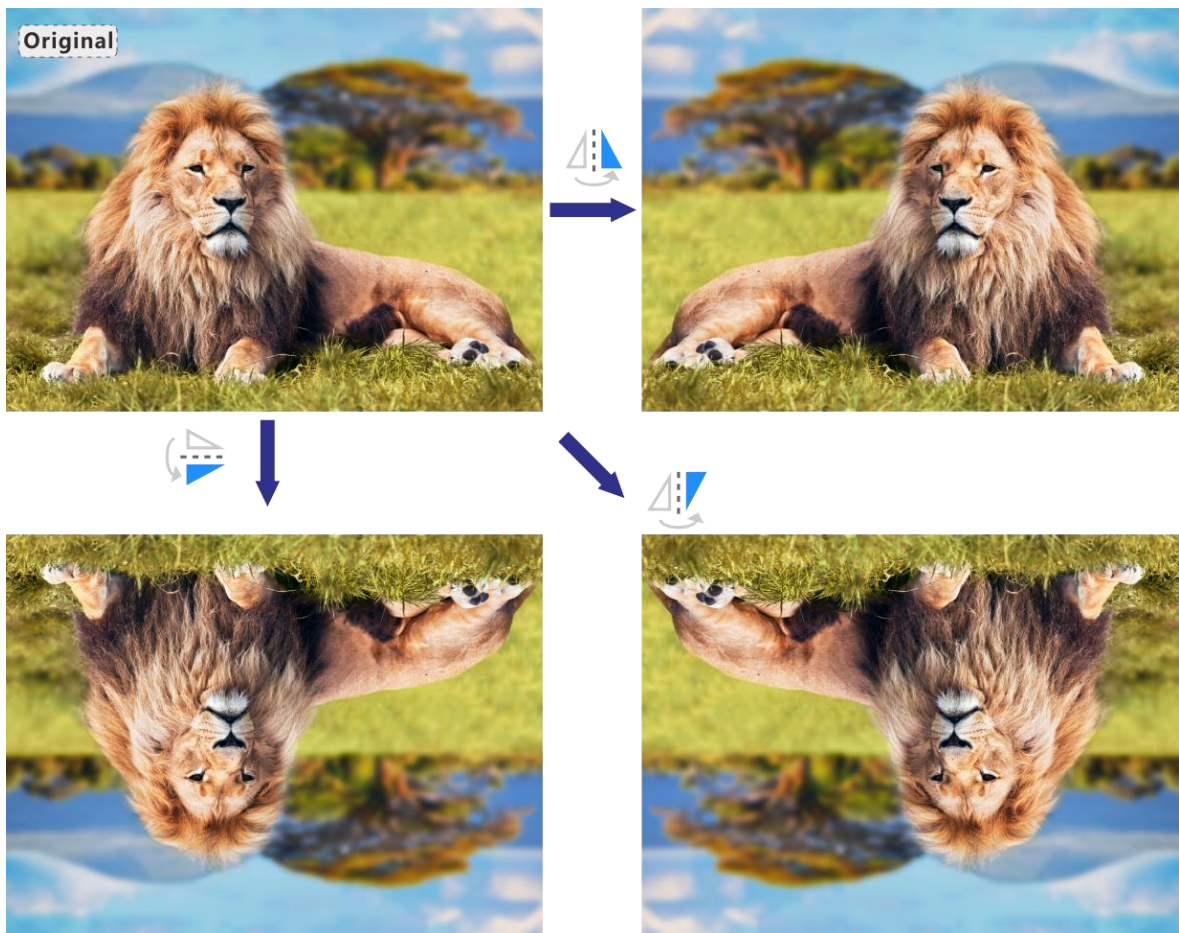

- Click **Layout** to add and arrange multiple layers, and then all the added layers will fill the whole screen according to the layout you selected. The layout options are 2x2, 3x3 and 4x4.
- Click **Clear** to quickly clear all the added layers.

Layer Menu

The layer menu shown at the top right corner varies with the layer input source. When you use a local input source to add a layer, the layer menu is shown as [Figure 4-3](#).

Figure 4-3 Layer menu-1



- Layer 1: The layer name
- : The icon will appear after you configure the reverse control for the input source. Click this icon to enter the desktop of your local computer to reversely control the input source PC.
- : Display or undisplay the layer image on the Web page.
- : Freeze or unfreeze the layer image.
- : Lock or unlock the layer.
- : Display the layer in full screen or restore the layer to its original size and position.
- : Delete the layer.

When you use an IPC source to add a layer, the layer menu is shown as [Figure 4-4](#).

Figure 4-4 Layer menu-2



Click  to view the details of the IPC source, including the decoding status, streaming media, decoding details and resource details of the IP input card.

Figure 4-5 Decoding status

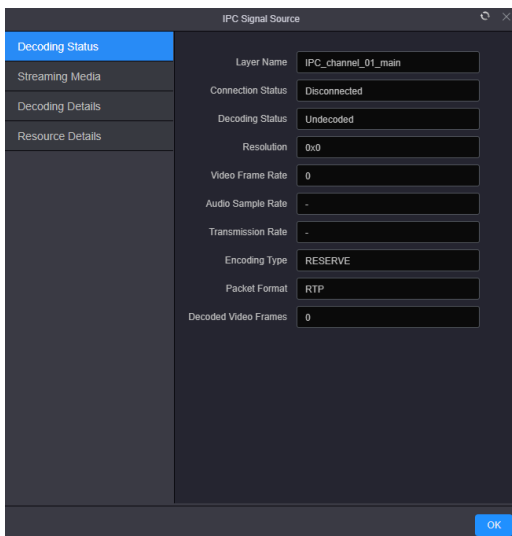

Figure 4-6 Streaming media

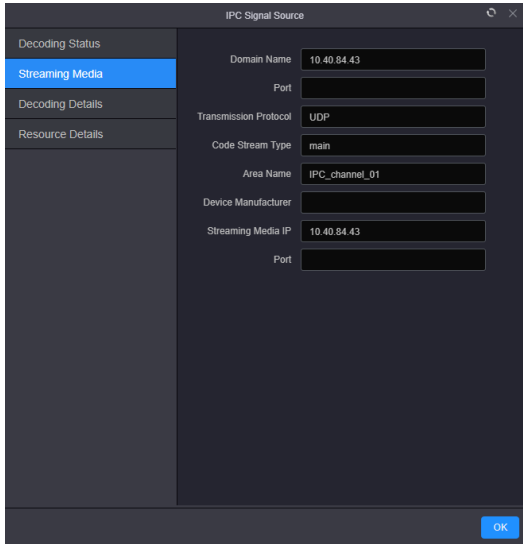

Figure 4-7 Decoding details

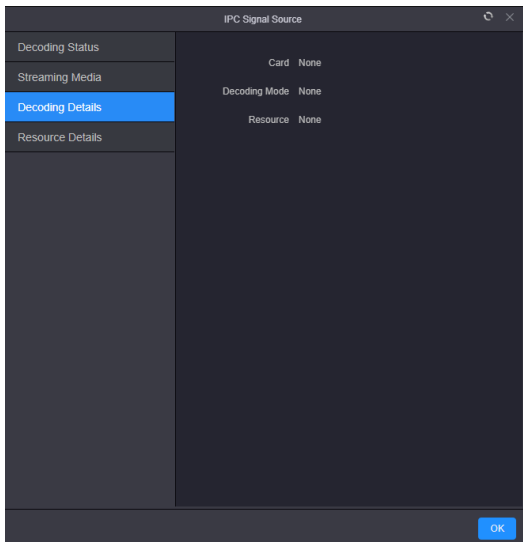
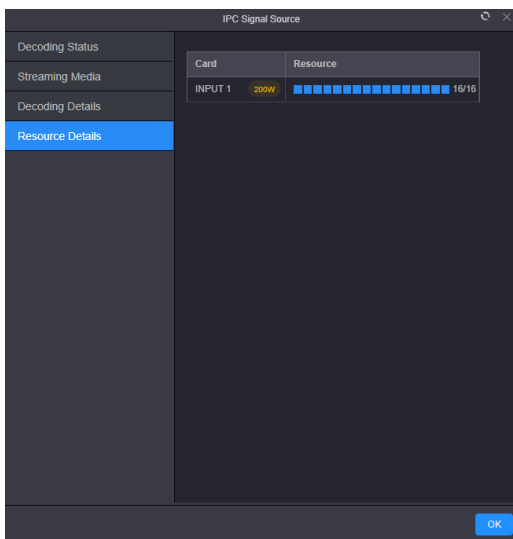

Figure 4-8 Resource details



Take to Screen

There are two taking to screen modes: **Live** and **Pre-Edit**.

- **Live (default):** The layer editing process is displayed on the screen in real time.

Figure 4-9 Live mode



- **Pre-Edit:** Deselect **Live**, and the layer editing process will not be displayed on the screen in real time. Click **Pre-Edit** after the layer editing is completed, and the screen will display the layer.

Figure 4-10 Pre-edit mode



Switch Layer Input Sources

Click an input in the **Input Signal** area on the left and drag it to an added layer to quickly switch the layer input source. The layer size and position remain the same.

Figure 4-11 Switch layer input sources

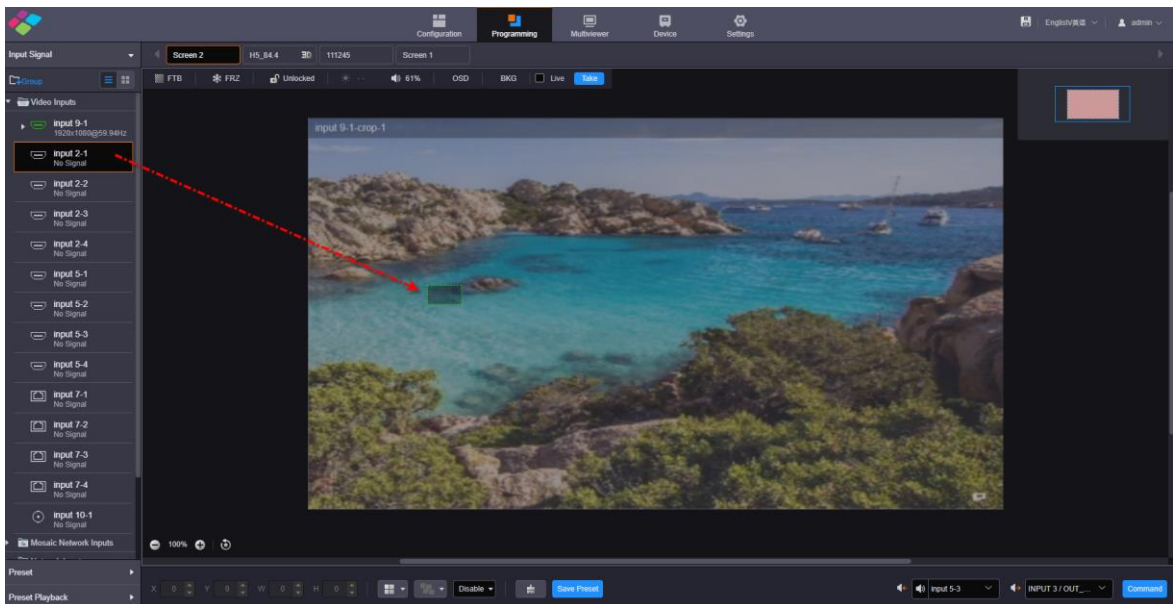

4.2 Add BKG

Make sure you have imported the BKG files before you add a BKG. The added BKG fills the whole screen automatically and locates at the bottom. The size and priority of the BKG cannot be adjusted.

BKG does not occupy layer resources. The maximum size of a BKG reaches 15K in width and 8K in height.

Import BKG

- Step 1 On the **Programming** page, click **BKG** below the screen list area to expand the BKG settings pane.

Figure 4-12 Import BKG

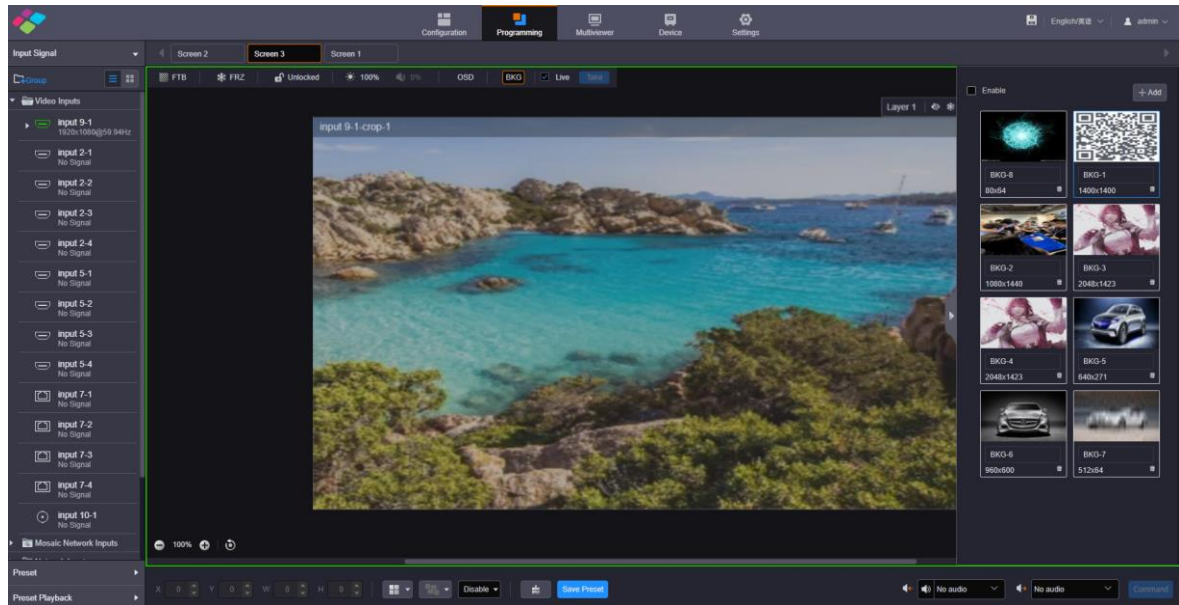

Step 2 Click **Add** to open the window where you can select and add a BKG file.

Step 3 Select the desired file and click **Open** to add it to the BKG list.

Add BKG

Step 1 On the BKG settings pane, select the desired BKG image.

Step 2 Check the box next to **Enable** to turn on the BKG function.

The system will use the selected image as background automatically.

Note:

Click another image in the BKG list to replace the current BKG.

4.3 Add OSD

The H series supports both OSD text and OSD image settings. OSD text supports scrolling.

On the **Programming** page, click **OSD** below the screen list area to expand the OSD settings pane.

Figure 4-13 Add OSD

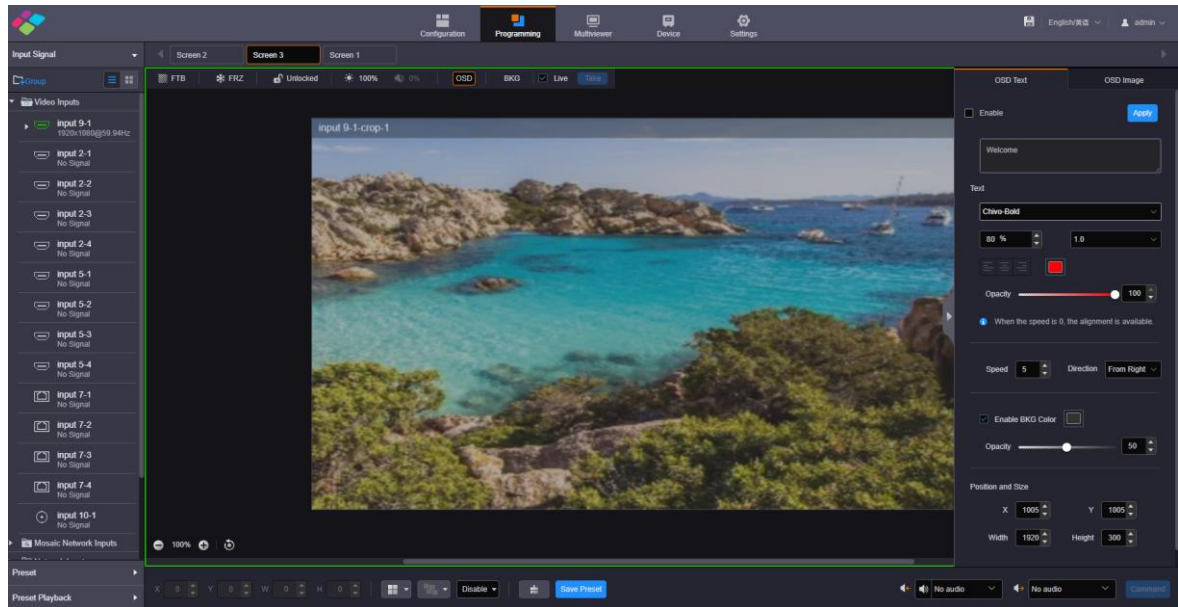

OSD Text

- Step 1 Click the **OSD Text** tab to show the OSD text settings.
- Step 2 Check the box next to **Enable** to turn on the OSD text settings.
- Step 3 In the text box below **Enable**, enter the OSD text content.

Figure 4-14 OSD text box

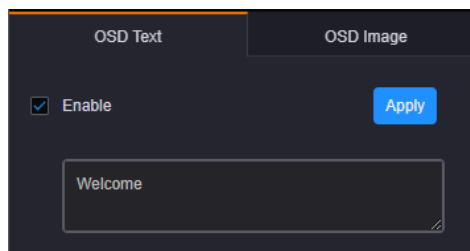

- Step 4 Set the OSD text properties.

Figure 4-15 OSD text properties

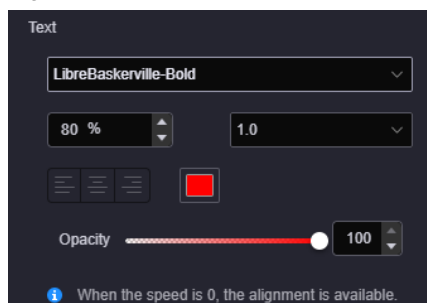

- Set the text font.
From the drop-down list below **Text**, select the desired text font.
- Set the text size.
In the left text box below **Text**, set the font size. The text size is shown in percentage that indicates the ratio of the text size to the text position height.

- Set the text spacing.



From the right drop-down list below **Text**, set the spacing between two letters or characters.

- Set the text color.

Click the color block icon below **Text** to select an existing color or enter the RGB values to define a custom color in the window that appears. After the settings, click OK to apply the color.

- Set the text alignment method.

When the text is static which means the text scrolling speed is set to 0, the alignment item is available. Three alignment options are provided.

-  (Align left): Align the text content with the left margin of the OSD area.
-  (Center): Center the text content in the OSD area.
-  (Align right): Align the text content with the right margin of the OSD area.

- Set the opacity of the OSD text.

The opacity ranges from 0% (totally transparent) to 100% (nontransparent).

You can change the opacity in the following three ways.

- Drag the opacity slider.
- Click the up or down arrow button next to the text box.
- Enter an opacity value in the text box.

Step 5 Set the OSD text scrolling properties.

- Speed: Set the scrolling speed. The value ranges from 0 (static) to 10 (fastest).
- Direction: Set the scrolling direction. The options are **From Right (default)** and **From Left**.

Step 6 Set the background color of the OSD text.

1. Check the box next to **Enable BKG Color** to turn on the background for OSD text.
2. Click the color block icon next to **Enable BKG Color** to open a window where you can select or custom colors.
3. Select an existing color or enter the RGB values to define a custom color in the displayed window.
4. Click **OK** to complete the settings.
5. Set the opacity for the OSD background.

Step 7 Set the OSD position and size.

- Position:
 - X: Set the horizontal distance from the top left corner of the OSD to that of the screen.
 - Y: Set the vertical distance from the top left corner of the OSD to that of the screen.
- Size:
 - Width: Set the OSD area width. The value ranges from 64 to 19200 pixels.
 - Height: Set the OSD area height. The value ranges from 64 to 3240 pixels.

Step 8 Click **Apply** at the top right corner of the OSD settings pane to complete the OSD text settings and display the OSD text on the screen.

OSD Image

Step 1 Click the **OSD Image** tab to show the OSD image settings.

Step 2 Check the box next to **Enable** to turn on the OSD image settings.

Step 3 Click **Upload** to open a window where you can select the desired OSD images.

Step 4 Click **Open** to upload the selected images.

Step 5 Set the OSD image properties.

- X: Set the horizontal initial position of the OSD image.

- Y: Set the vertical initial position of the OSD image.
- Width: Set the width of the OSD image.
- Height: Set the height of the OSD image.
- Opacity: Set the opacity of the OSD image.

Step 6 Click **Apply** at the top right corner of the OSD settings pane to complete the OSD image settings and display the OSD image on the screen.

Notes:

After an OSD image is applied, you can click **Upload** and select a new image to replace the current one.

Click **Crop** to crop the added OSD image if necessary.

On the Web page, you can click and drag the OSD to quickly adjust its position.

Delete OSD

Step 1 Select the **OSD Text** or **OSD Image** tab to expand the OSD text or image settings pane.

Step 2 Uncheck the box next to **Enable**.

Step 3 Click **Apply** to delete OSD.

4.4 Set Presets

After the layer settings, you can save the current layer layout and settings as a preset for future use.

Save Presets

Step 1 On the **Programming** page, click **Save Preset** at the bottom to open the preset saving window.

Figure 4-16 Save presets

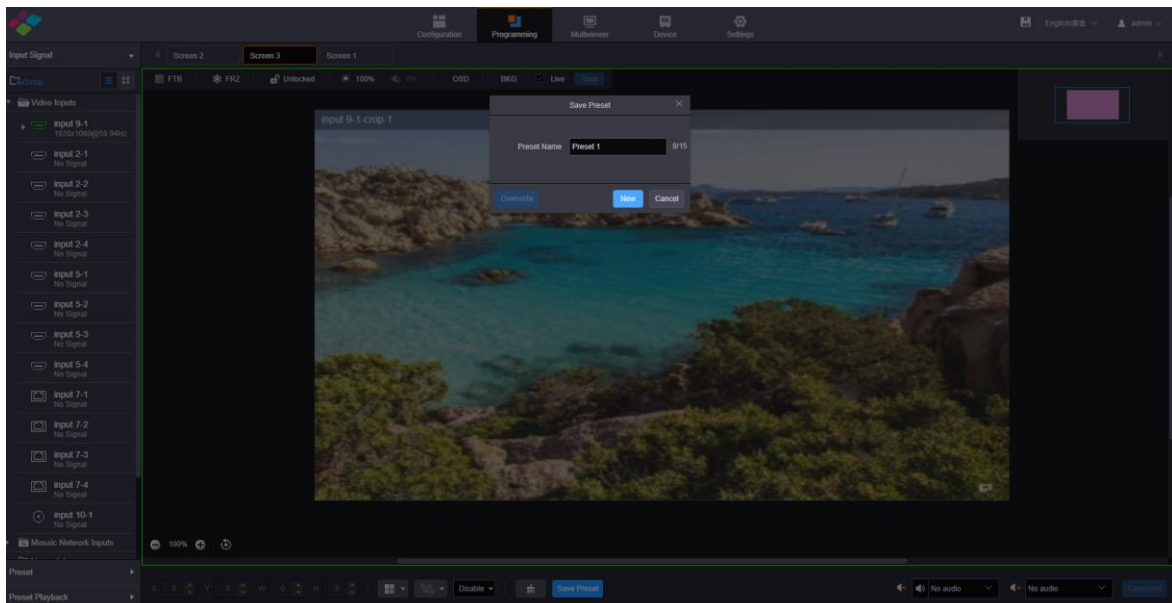

Step 2 Enter a preset name that is easier for you to remember and identify the preset quickly.

Step 3 Click **New** to save the preset.

Load Presets





The preset is screen-specific, so select a configured screen before you load a preset.

Step 1 On top of the **Programming** page, select the screen that you will operate.

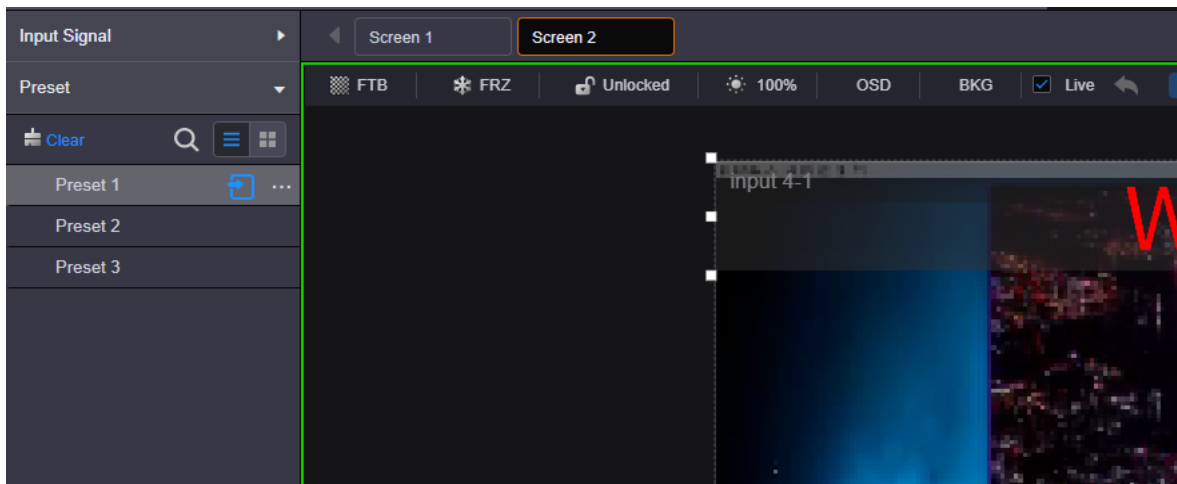
Step 2 Click **Preset** on the left to expand the preset list.

Figure 4-17 Load presets



- Click  to search the presets by name.
- Click  to switch to the list view.
- Click  to switch to the thumbnail view that allows you to view the layer layout of the preset.
- Click  to clear all the presets.

Step 3 Click a preset and the  icon appears next to the preset name. Click this icon to load the current preset to the screen.

Other Preset Operations

Click a preset and ... appears next to the preset name. Click this icon to open the preset operations menu.

Figure 4-18 Preset operations menu

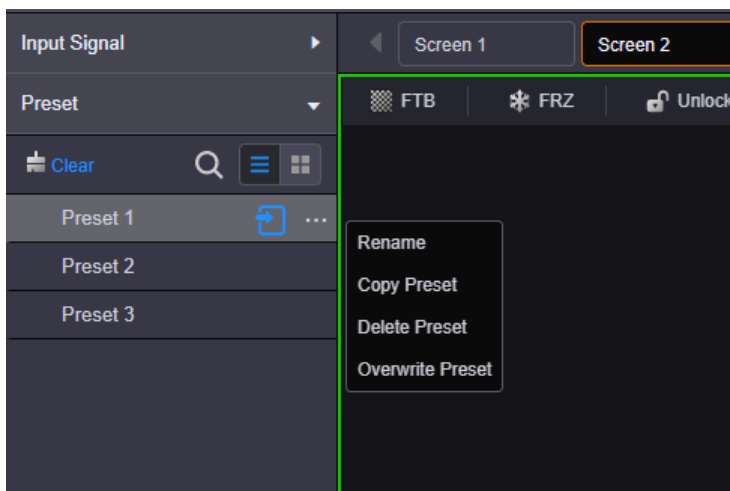

- **Rename:** Rename the saved preset.
- **Copy Preset:** Copy the layer layout and content in the current preset to a new preset.
- **Delete Preset:** Delete the selected preset.
- **Overwrite Preset:** Overwrite the selected preset with a new preset.

4.5 Set Preset Playbacks

The preset playback function allows you to play the presets automatically based on the set playback sequence and single preset playback duration. After the settings, the system will play the presets automatically with no manual operations required.

Add Preset Playbacks

Step 1 On the **Programming** page, click **Preset Playback** on the left to enter the playback settings page.

Figure 4-19 Add preset playbacks - 1

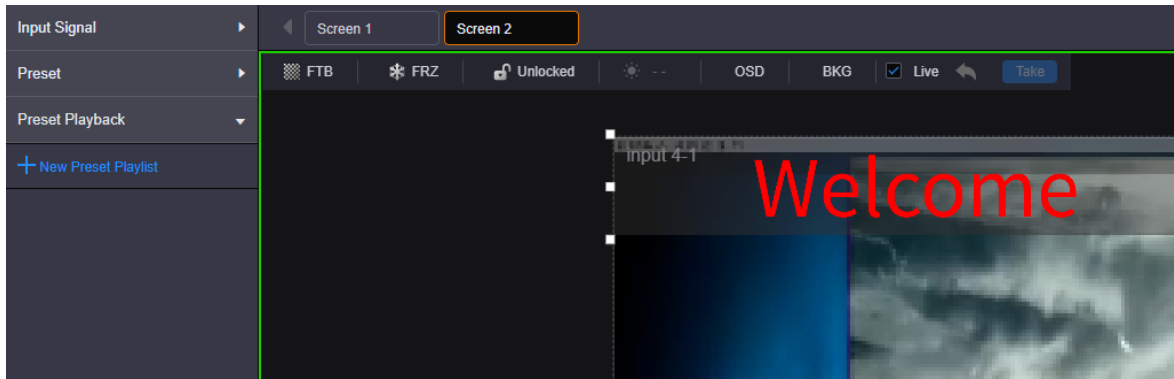

Step 2 On top of the page, select the screen that you will operate.

Step 3 Click **New Preset Playlist** to add a new playback and enter the playback settings page.

Figure 4-20 Add preset playbacks

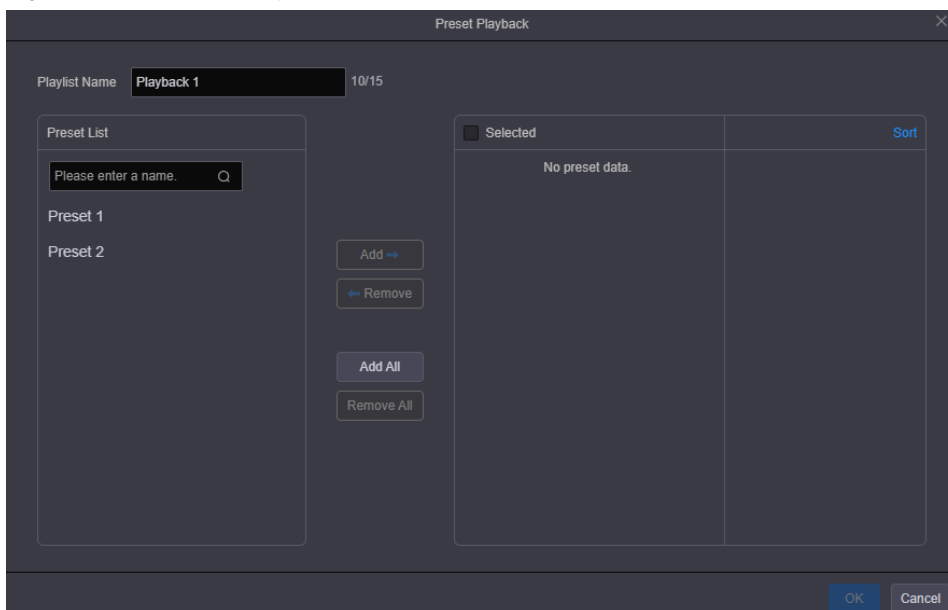

Step 4 Enter a name for the new playback.

Step 5 Select the desired presets in the **Preset List** area on the left, and then click **Add** to add the selected presets to the **Selected** area.

- **Remove:** Select the desired presets in the **Selected** area and click **Remove** to remove them from the list and make them go back to the left area.
- **Add All:** Add all the presets in **Preset List** to **Selected**.
- **Remove All:** Remove all the presets in **Selected**.

Step 6 Set the playback duration that specifies the time length each preset lasts.

The default playback duration is 5s. You can change the playback duration as follows.

1. Check the box next to the desired preset in the **Selected** area.
2. Enter the playback duration in the text box on the right.
3. Press **Enter** or click somewhere else on the Web page to complete the settings.

When you want to set the same playback duration for all the selected presets, check the boxes next to the desired presets and then click **Uniform Duration**. In the popup text box, enter the desired playback duration and then press **Enter** to complete the settings.

Step 7 [Optional] Adjust the preset playback sequence.

The sequence that you add the presets is the default preset playback sequence. You can adjust the sequence as follows.

1. In the **Selected** area, click **Sort** at the top right corner.
2. Move up and down the preset to adjust the preset sequence in the preset playback list.
3. Click **Done** at the top right corner to complete the adjustment.

Step 8 Click **OK** to complete the settings.

Play Presets

Step 1 On top of the **Programming** page, select the screen that you will operate.

Step 2 Click **Preset Playback** on the left to expand the preset playback list.

Step 3 Click the  icon to play the selected preset playlist. The screen is locked during the playback.

Figure 4-21 Play presets

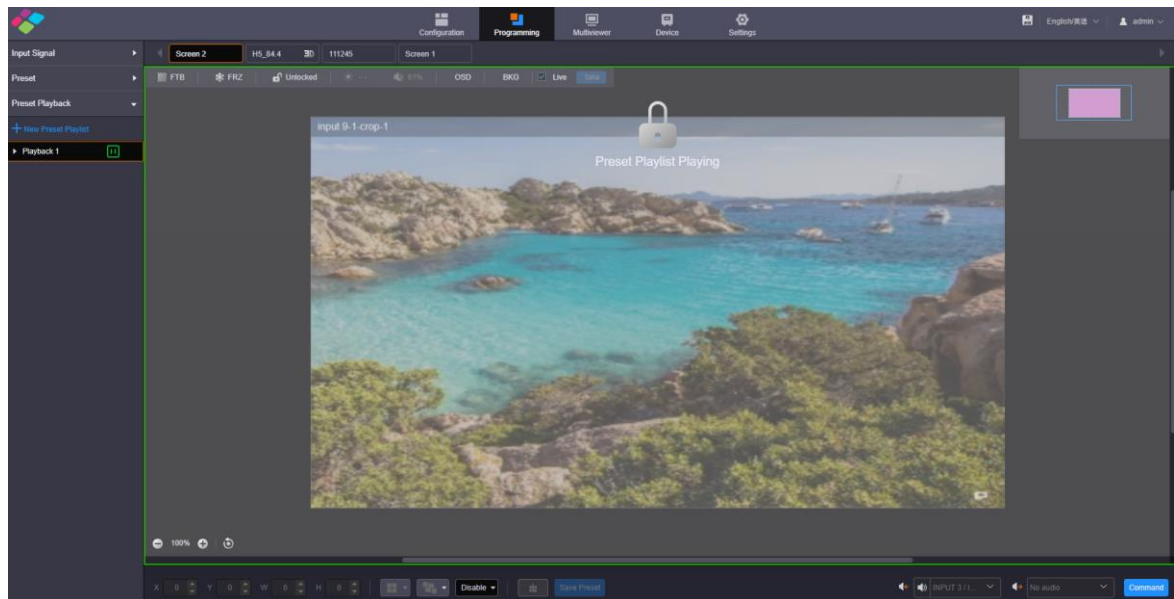

Click the  icon to pause the playback.

Other Playback Operations

Click a playback and ... appears next to the playback name. Click this icon to open the playback operations menu.

Figure 4-22 Playback operations menu

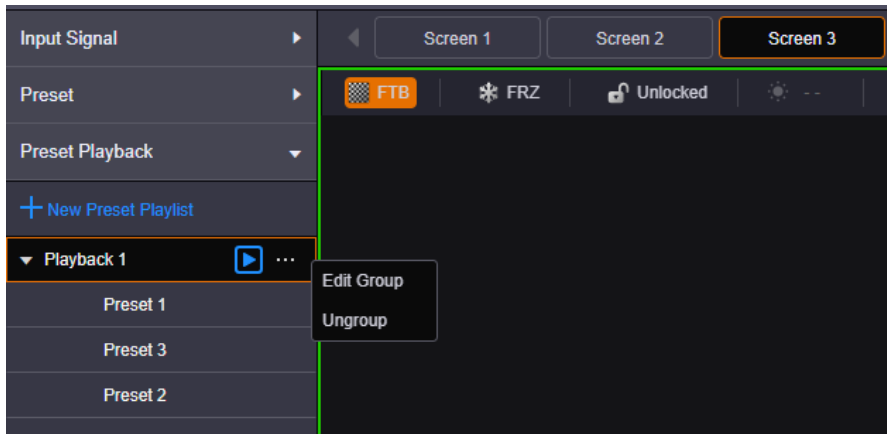

- Edit Group: Rearrange the preset list and readjust the playback duration.
- Ungroup: Ungroup the current playlist.

4.6 Group Input Sources

The H series supports input source group management.

- Step 1 On the **Programming** page, click **Input Signal** on the left to view the input source list. The green connectors are accessed with signal sources.
- Step 2 Click **Group** to open the grouping window.

Figure 4-23 Group input sources

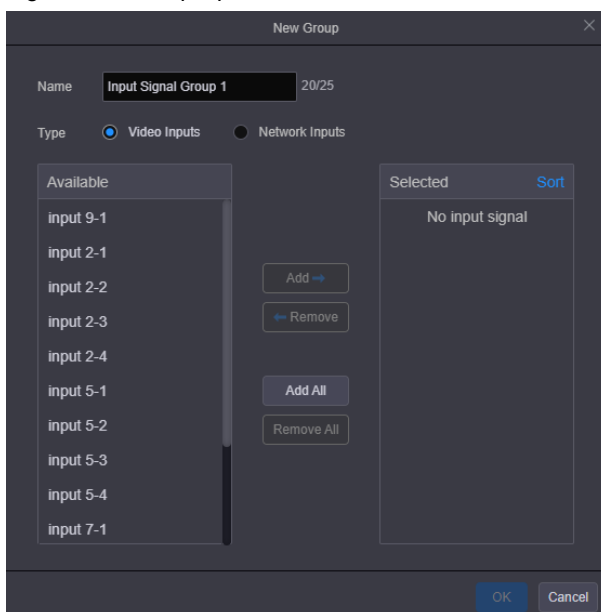

- Step 3 Enter a name for the group.
- Step 4 Select the desired input source type.
 - Video Inputs: Group the local input sources.
 - Network Inputs: Group the input sources connected to the IP input card.
- Step 5 Select the desired inputs in the **Available** area on the left.
- Step 6 Click **Add** to add the selected inputs to the **Selected** area.
 - Remove: Select the desired inputs in the **Selected** area and click **Remove** to remove them from the list and make them go back to the left area.

- Add All: Add all the inputs in **Available** to **Selected**.
- Remove All: Remove all the inputs in the **Selected** area.

Step 7 Click **OK** to complete the grouping.

4.7 Crop Input Sources

The H series supports the input source cropping function. The cropped input source can be used as a new input source.

- Step 1 On the **Programming** page, click **Input Signal** on the left to view the input source list. The green connectors are accessed with signal sources.
- Step 2 Select an input source and ... appears next to the input source name.
- Step 3 Click ... to open the input source operations menu.

Figure 4-24 Input source operations menu

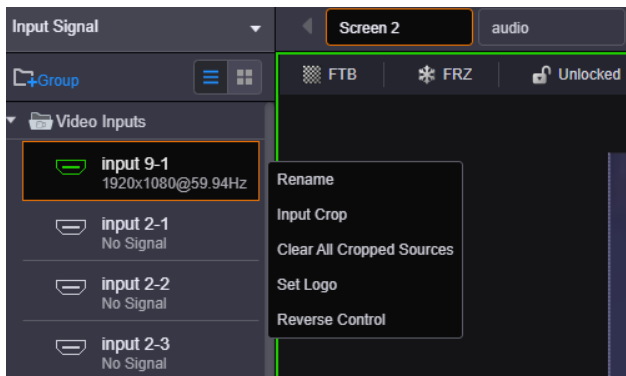

- Step 4 Select **Input Crop** to open the input source cropping window.

Figure 4-25 Crop input source

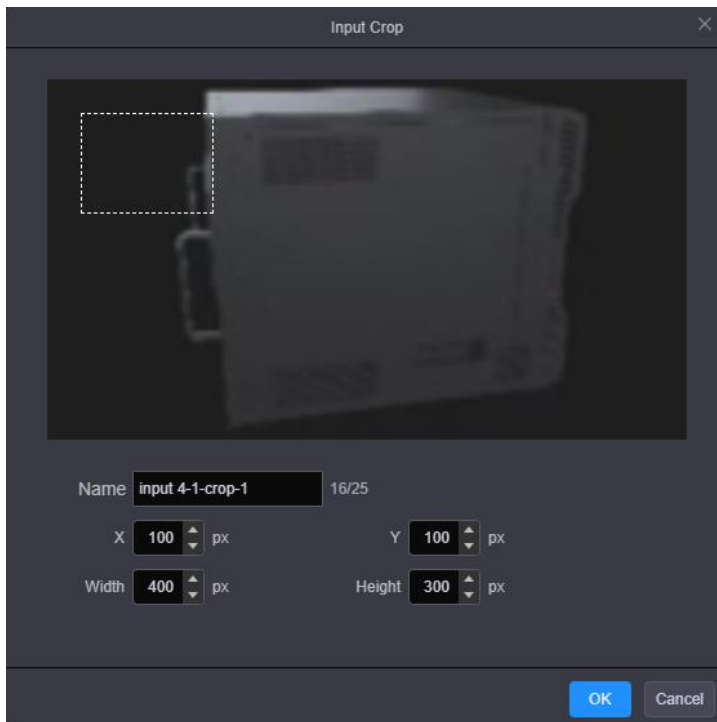

- Step 5 Name the cropped input source image.

- Step 6 Enter the values in the **X** and **Y** text boxes to set the horizontal and vertical start positions respectively for the cropping. The cropping reference is the top left corner of the input source image.
- Step 7 Enter the values in the **Width** and **Height** text boxes to set the width and height of the left area after cropping.

Note:

After the width and height values are set, click and drag the highlighted frame on the input source area to quickly adjust the start position for the cropping.

- Step 8 Click **OK** to complete the cropping.

After the cropping, the new input source appears below the original input source in the **Input Signal** area. For the new input source, the operations such as renaming and cropping are also provided.

Figure 4-26 Cropped input source

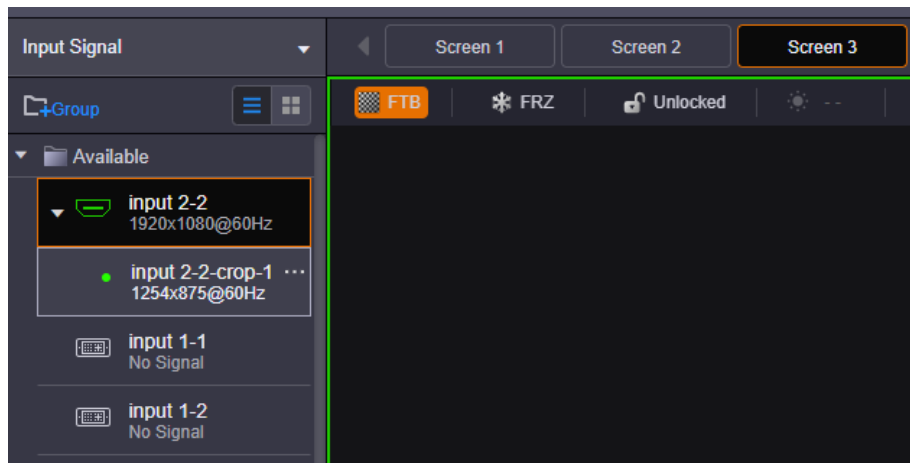
**Note:**

In the input source operations menu, click **Clear All Cropped Sources** to delete all the cropped sources.

4.8 Set 3D Effect

The H series can work with the EMT200 3D emitter from NovaStar and 3D glasses to provide you with 3D visual experience.

You can set the 3D parameters in NovaLCT or on the Web.

Notes:

Turning on 3D mode will halve the device output capacity.

The 3D and low latency functions cannot be turned on at the same time.

For pixel-to-pixel display in 3D mode, if the 3D source is in side-by-side format, the layer width must be set to half of the input source width; if the 3D source is in top-and-bottom format, the layer height must be set to half of the input source height.

Figure 4-27 Hardware connections

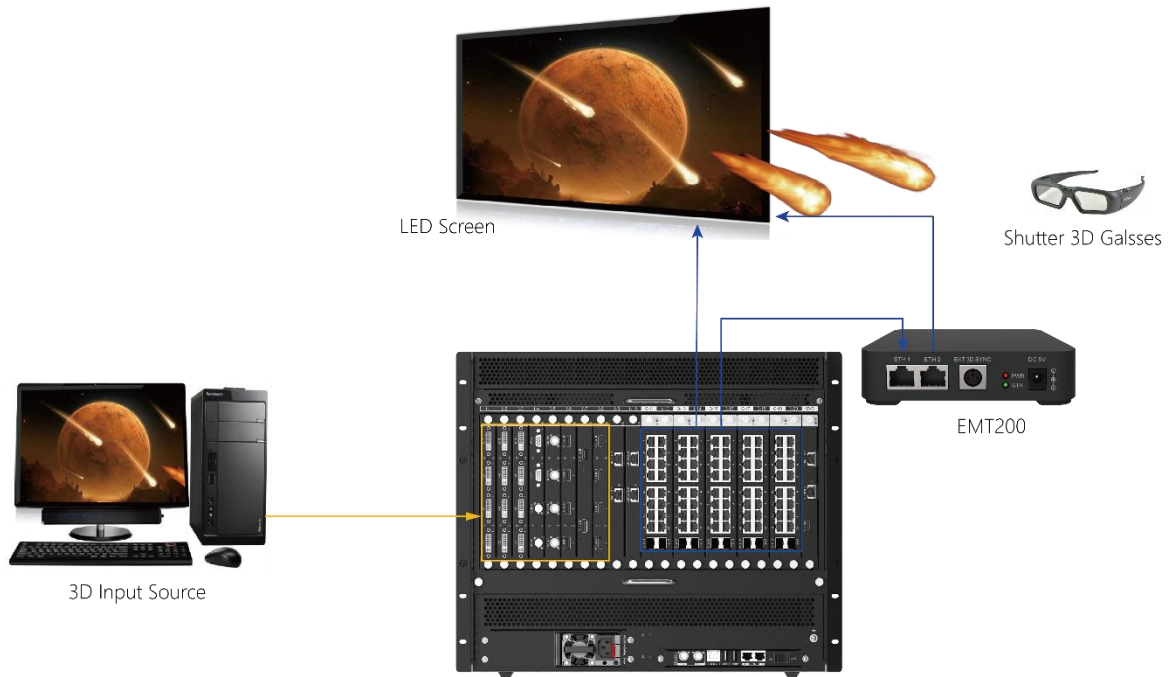

The EMT200 is connected in between the LED 4K sending card and the receiving card via Ethernet cables, or connected to any of the receiving cards.

Each screen supports only one EMT200.

- Step 1 Log in to NovaLCT.
- Step 2 Go to **Screen Configuration > Sending Card** to open the sending card window.
- Step 3 Check the box in front of **Enable** to turn on the 3D function.
- Step 4 Click **Set 3D Parameters** to open the 3D parameter settings window.

Figure 4-28 Set 3D parameters

- Step 5 Select the video source format. The options are **Side-by-Side**, **Top-and-Bottom** and **Frame Sequential**.
- Step 6 Set the eye priority according to the 3D glasses mode. The options are **Left eye** and **Right eye**.
- Step 7 Set the right eye start position.

Notes:

For side-by-side 3D sources, **Right Eye Start** must be set to half of the input source width.
 For top-and-bottom 3D sources, **Right Eye Start** must be set to half of the input source height.

- Step 8 Select or unselect **Enable third-party emitter** according to your actual setup.
- Step 9 Adjust the signal delay time to make left and right eye images of the 3D glasses in sync with the images on the display.

3D Settings on Web

You can set the 3D effect on the Web page.

- Step 1 Click **Configuration** to enter the screen configuration page.
- Step 2 Select the desired screen on the top of the page.
- Step 3 Click  on the right edge to expand the configuration settings pane.
- Step 4 Click the **Basic Info** tab to show the basic settings.
- Step 5 Check the box next to **3D** to turn on the 3D function.

Figure 4-29 3D settings



- Step 6 Select the video source format based on the accessed 3D source. The options are **Side-by-Side** and **Top-and-Bottom**.
- Step 7 Set the eye priority according to the 3D glasses mode. The options are **Right Eye** and **Left Eye**.
- Step 8 Set the right eye start position.

Notes:

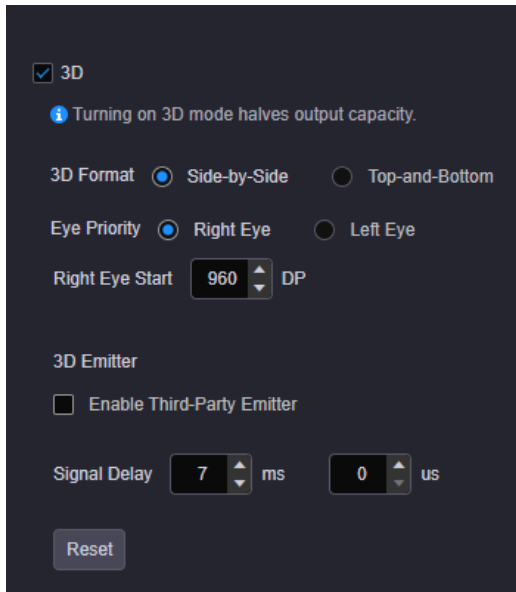
For side-by-side 3D sources, **Right Eye Start** must be set to half of the input source width.

For top-and-bottom 3D sources, **Right Eye Start** must be set to half of the input source height.

- Step 9 Select or unselect **Enable Third-Party Emitter** according to your actual setup.
- Step 10 Adjust the signal delay time to make left and right eye images of the 3D glasses in sync with the images on the display.

4.9 Set Channel Logos

The channel logo function allows you to set a logo for each input source, which is displayed on the top left of the layer. By using this function, you can quickly locate and identify the input source of the layer.

Figure 4-30 Channel logo

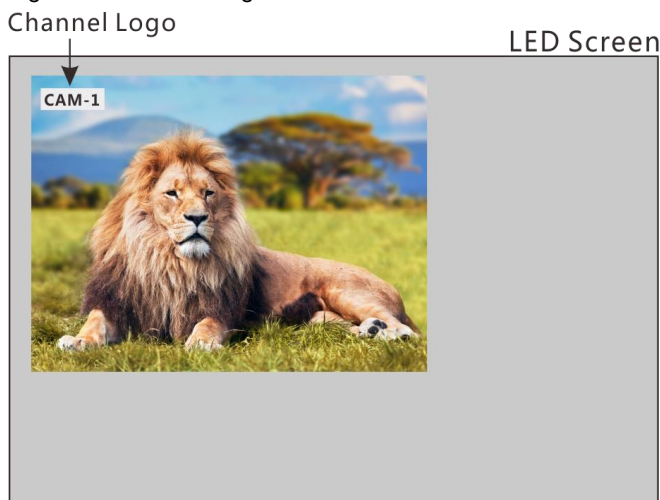

- Step 1 Select an input source and ... appears next to the input source name.

Step 2 Click ... to open the input source operations menu.

Figure 4-31 Input source operations menu

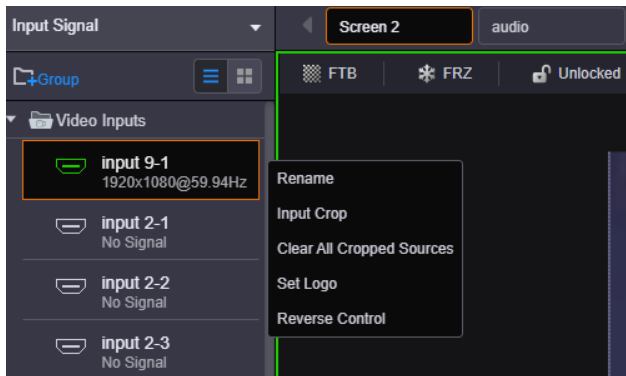

Step 3 Select **Set Logo** to open the channel logo settings window.

Figure 4-32 Set logo

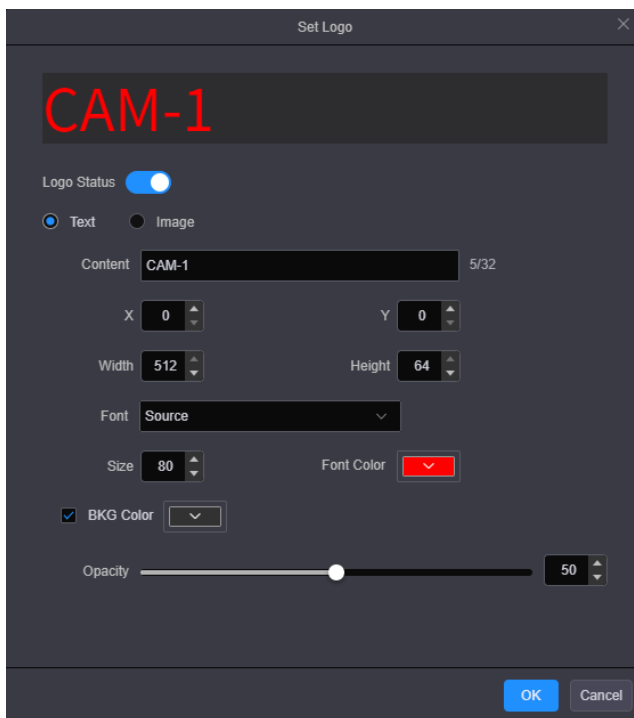

Step 4 Enable the logo function.

The H series supports text or image channel logos.

- Text logo
 - a. Enter the logo text in the **Content** text box.
 - b. Enter the values in the **X** and **Y** text boxes to set the position of the logo upon the input source.
 - c. Enter the values in the **Width** and **Height** text boxes to set the logo size.
 - d. Set the text font, size and color for the logo text.
 - e. Select **Enable BKG** and select a color for the logo background.

- Image logo

Click **Browse** to import an image as the channel logo, and then set the **X** and **Y** values to set the logo position.

The maximum width and height of the logo image can be up to 512 and 64 pixels respectively.

4.10 Set Reverse Control

When the signal source is a local signal source output by the computer, the H series supports reverse control of the signal source.

Prerequisites

The signal source to be controlled reversely must be the local source provided by the computer running the Windows operating system.

Operating Procedure

- Step 1 On the **Programming** page, select an input source and ... appears next to the input source name.
- Step 2 Click ... to open the input source operations menu.

Figure 4-33 Input source operations menu

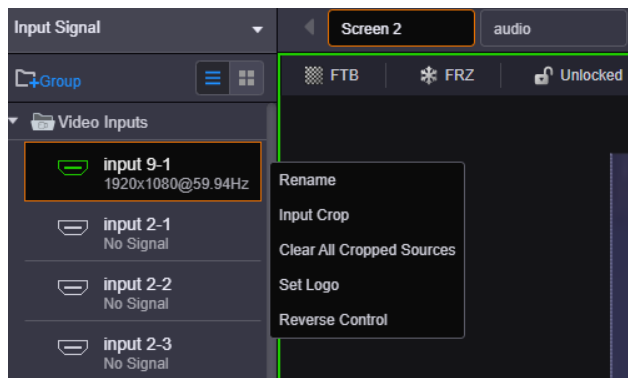

- Step 3 Click **Reverse Control** to open the reverse control settings window.

Figure 4-34 Set reverse control

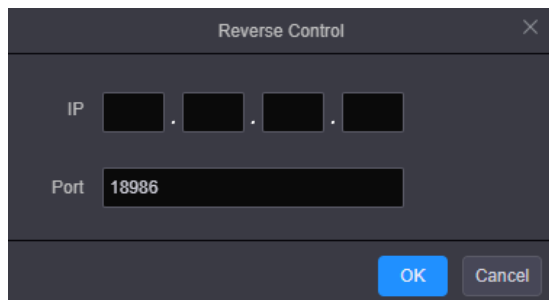

- Step 4 Enter the IP address of the input source PC and use the default port number **18986**.
- Step 5 Click **OK** to complete the settings.
- Step 6 Use the signal source configured for reverse control to add a layer.

Figure 4-35 Add layers

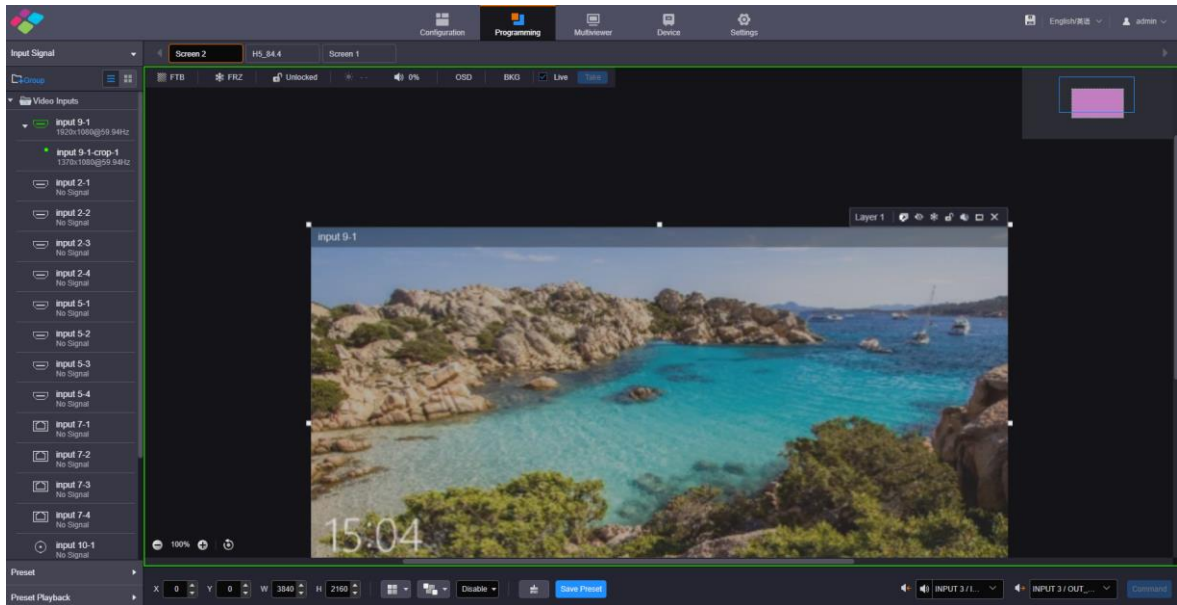



Step 7 In the layer menu, click  to enter the desktop of the input source PC and then you can reversely control the PC.

Figure 4-36 Reverse control desktop

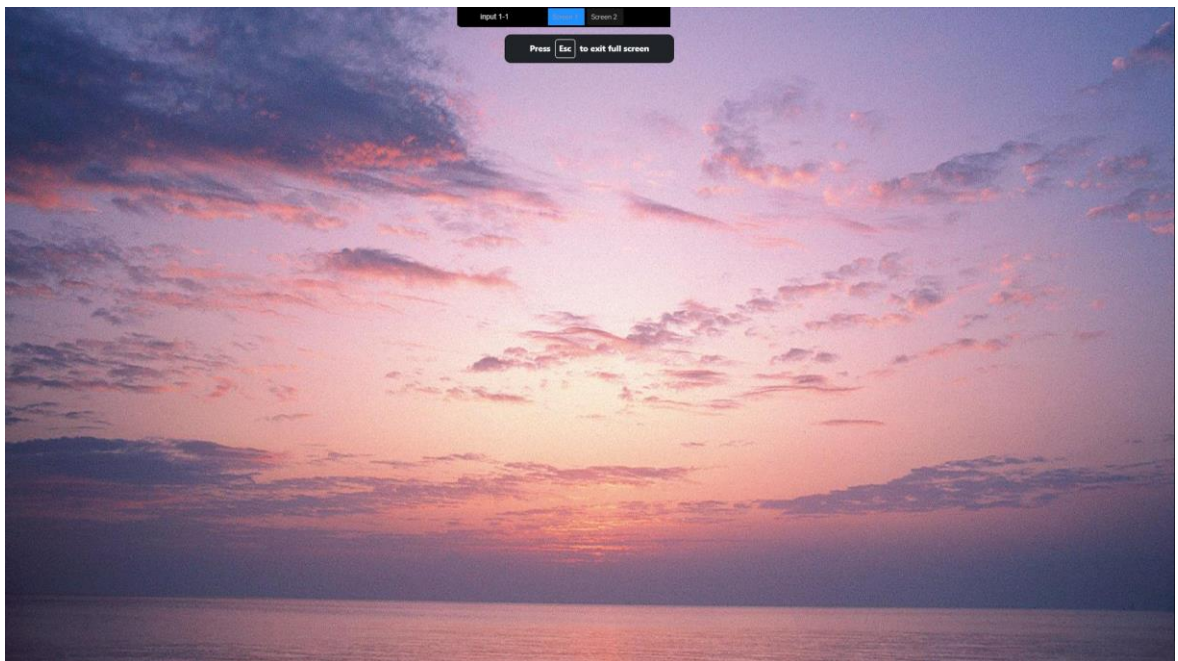

After you enter the desktop of the input source PC, you can operate the files and programs on the PC. If the input source PC is configured with multiple output desktops, the system will display the desktop names. You can click the name to switch to the target desktop.

You can exit the reverse control desktop in the following ways.

- Press **ESC**.
- Hover the mouse over the desktop name area at the top and  will appear. Click this icon to exit the reverse control desktop.
- Click the input source name displayed in the desktop name area.

4.11 Set Output Audio

When an H series device is installed with an H_2xAudio input+2xAudio output card, the audio output is supported.

Step 1 Click **Programming** to enter the programming page.

Figure 4-37 Set input and output audio

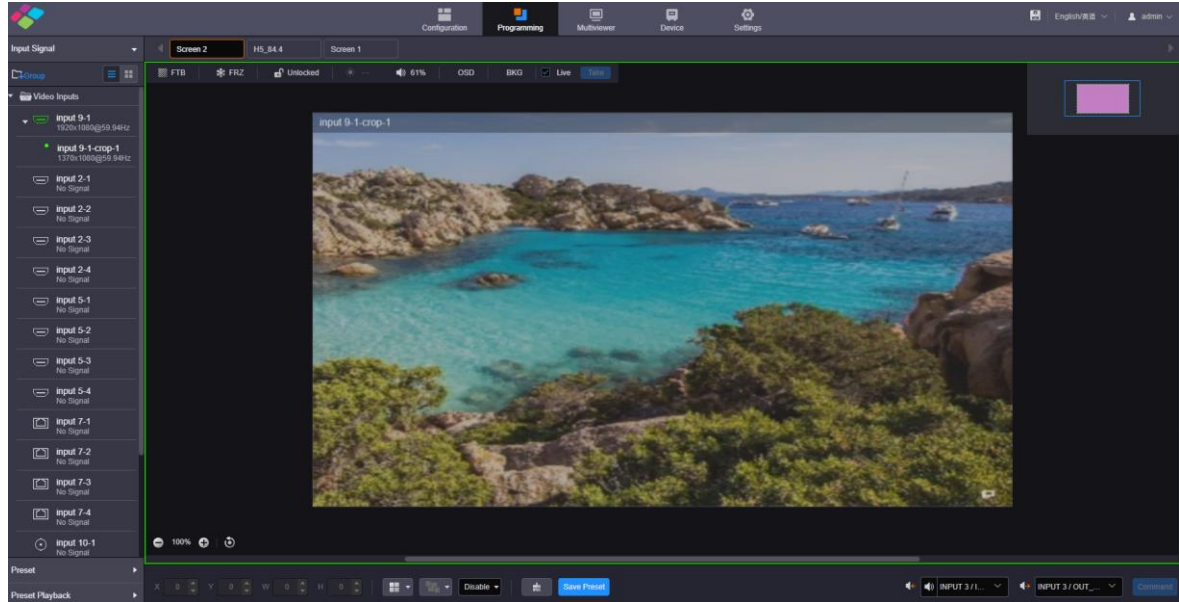

Step 2 Set the input audio.

Click the drop-down list next to  at the bottom right corner, and then select the input source audio. The options include the audio coming with an input connector on the audio card and the accompanied audio coming with an HDMI input connector.

Step 3 Set the output audio.

Click the drop-down list next to  at the bottom right corner, and then select the audio output connector. The audio can be output via an output connector on the audio card.

4.12 Set Input and Output EDID

Step 1 Go to **Settings > EDID Management** to enter the EDID settings page.

Figure 4-38 EDID management

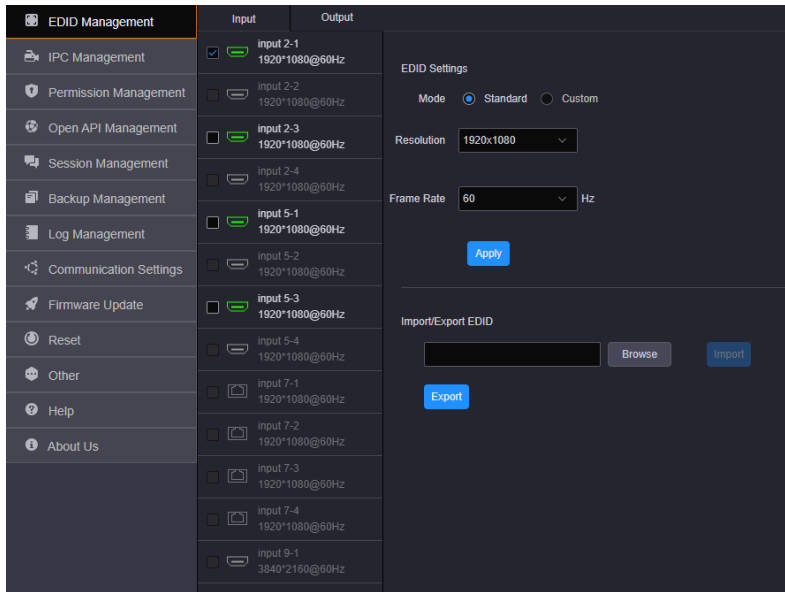

Step 2 Click the **Input** or **Output** tab to view the input or output connector resolution.

Step 3 Select the desired input or output connectors.

- Standard Resolution

Select a standard resolution from the drop-down list.

- Custom Resolution

Set the width, height and frame rate for the input or output connectors, and then click **Apply** to complete and apply the settings.

- Advanced

Under custom mode, you can select **Advanced** to enable the advanced EDID settings function. It is recommended personnel who are familiar with the EDID settings adopt this method. The parameters for advanced EDID settings are shown as follows.

Figure 4-39 Parameters for advanced EDID settings

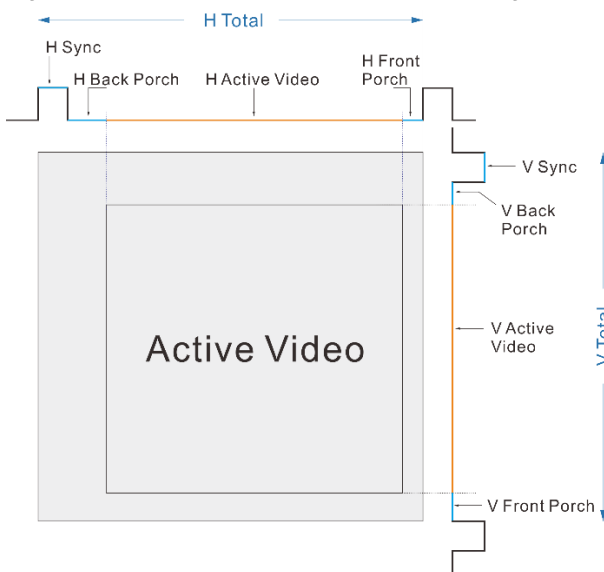

- Import/Export EDID

Export the configured resolution parameters file for future use, or import an existing EDID configuration file.

Note:

The H_16xRJ45+2xfiber sending card and H_20xRJ45 sending card support custom resolution settings only.

4.13 Control Backend Devices

The H series supports the control of other devices via the COM OUT port on the H_Control card.

Prerequisites

- The controlled device is connected to an H series device via a serial cable.
- You have added the control commands as described in [6.5.8.4 Add Commands](#).

Operating Procedure

Step 1 On the **Programming** page, click **Command** at the bottom right corner to show the command list.

Figure 4-40 Command list

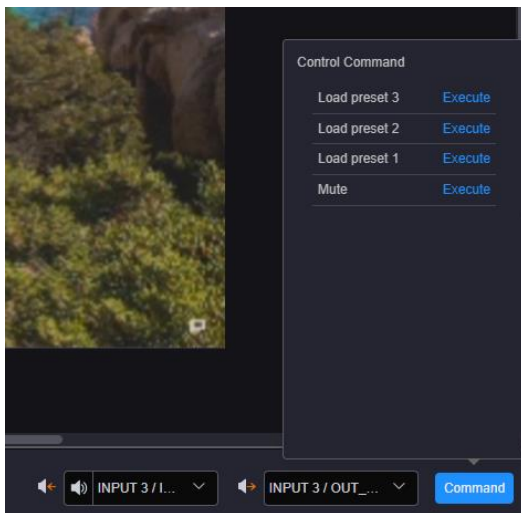

Step 2 Select the desired control command and click **Execute** to execute the selected one.

4.14 Manage Roles

You can add new roles as needed and grant them different operation permissions. When a user is associated with a role, the user obtains the permissions that the role has.

Add Roles

Step 1 Go to **Settings > Permission Management > Role Management** to enter the role management page.

Figure 4-41 Role management

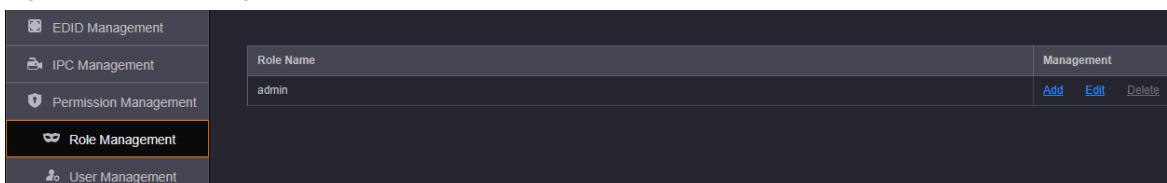

The user (admin) is created by default with all the operation permissions and data accesses.

Step 2 Click **Add** in the column of **Management** to add a new sub-role.

Figure 4-42 Add new roles

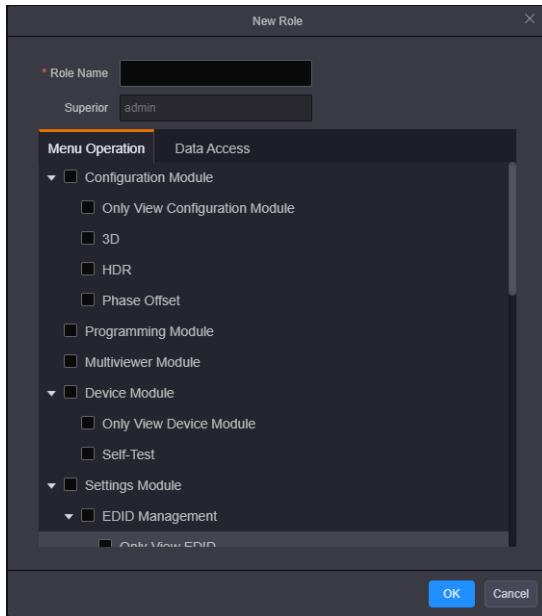

Step 3 Enter a name for the new role.

Step 4 Select the permissions below the **Menu Operation** tab.

Check the boxes in front of the desired modules, and then the role will obtain all the permissions below the selected modules.

Step 5 Below the **Data Access** tab, select the desired data accesses. The options include **Input**, **Output**, **Screen** and **Multiviewer**.

Step 6 Click **OK** to complete the adding.

On the role management page, click **Add** in the column of **Management** to create a new sub-role for the targeted role. The permissions granted to the sub-role are less than or equal to those of the superior role.

Change Role Information

Step 1 On the role management page, select the desired role.

Step 2 Click **Edit** in the column of **Management** to open the role editing window where you can change the role name, menu operations and data accesses.

Step 3 Click **OK** to complete the editing.

4.15 Manage Users

The H series supports multi-user collaboration at the same time. You can add new users as needed and manage their permissions.

Prerequisites

The role information is configured.

Step 1 Go to **Settings > Permission Management > User Management** to enter the user management page.

Figure 4-43 User management

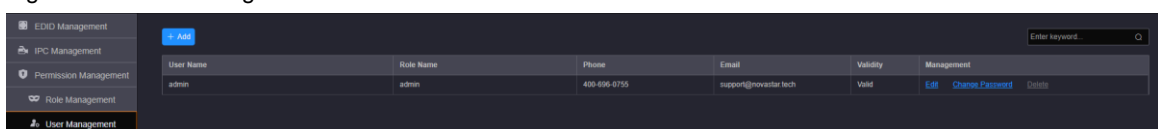

Step 2 Click **Add** to open the new user adding window.

Figure 4-44 Add new users

The 'New User' dialog box is a dark-themed window with a close button (X) in the top right corner. It contains the following fields and controls:

- User Name:** A text input field with an asterisk (*) indicating it is required.
- Password:** A password input field with an asterisk (*) indicating it is required.
- Phone:** A text input field.
- Email:** A text input field.
- Role Name:** A dropdown menu with the text 'Please select' and a downward arrow, with an asterisk (*) indicating it is required.
- Validity:** Two radio buttons labeled 'Valid' (selected) and 'Invalid'.
- Buttons:** 'OK' and 'Cancel' buttons at the bottom right.

Step 3 Enter a user name, password, phone number and email address.

Step 4 Click the drop-down arrow next to **Role Name** to select the target role.

Step 5 Select **Valid** to make the user account a valid one.

Step 6 Click **OK** to complete the adding.

In the user list, click **Edit** in the column of **Management** to change the user password, phone number, email address and role. You can also set the user account to an invalid one and the invalid user cannot log in to the system.

Click **Delete** in the column of **Management** to delete the desired user. After the user is deleted, it cannot log in to the system.

Change Password

Step 1 On the user management page, select the desired user.

Step 2 Click **Reset Password** in the column of **Management** to open the password changing window.

Figure 4-45 Change password

The 'Change Password' dialog box is a dark-themed window with a close button (X) in the top right corner. It contains the following fields and controls:

- User Name:** A text field displaying 'admin'.
- Old Password:** A password input field with an asterisk (*) indicating it is required.
- New Password:** A password input field with an asterisk (*) indicating it is required.
- Confirm Password:** A password input field with an asterisk (*) indicating it is required.
- Buttons:** 'OK' and 'Cancel' buttons at the bottom right.

Step 3 Enter your current password in the **Old Password** text box.

Step 4 Enter your new password both in the **New Password** and **Confirm Password** text boxes.

Step 5 Click **OK** to apply the change.

Note:

On the user management page, the user (admin) can reset the password for other users.

Change User Permissions

- Step 1 On the user management page, select the desired user.
- Step 2 Click **Edit** in the column of **Management** to open the user editing window.

Figure 4-46 Edit users

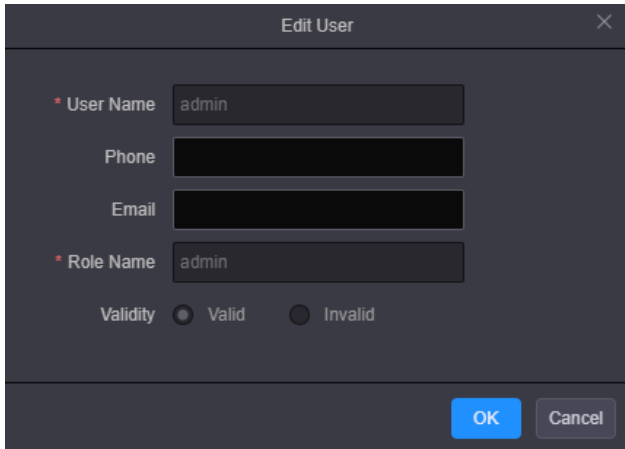

The screenshot shows a dark-themed dialog box titled "Edit User". It contains the following fields and controls:

- User Name:** A text input field containing the text "admin".
- Phone:** An empty text input field.
- Email:** An empty text input field.
- Role Name:** A text input field containing the text "admin".
- Validity:** Two radio buttons labeled "Valid" and "Invalid". The "Valid" radio button is selected.
- Buttons:** "OK" and "Cancel" buttons are located at the bottom right of the dialog.

- Step 3 Enter a new phone number and email address.
- Step 4 In the **Role Name** text box, change the role for the current user.
- Step 5 Click **OK** to apply the change.

5 LCD Menu Introduction

After the device is successfully powered on, the home screen is displayed as follows.

Figure 5-1 Home screen

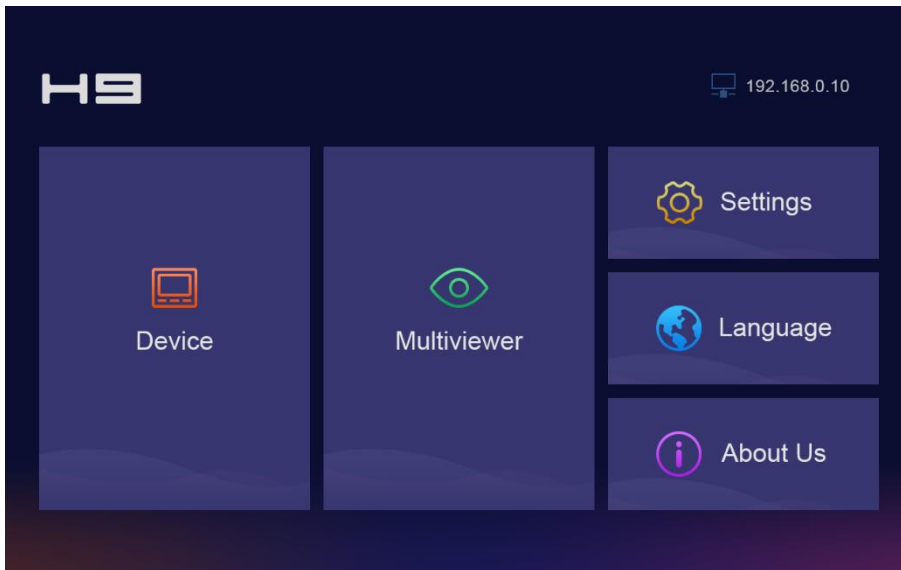

5.1 Device

Select **Device** to view the device-related information.

Figure 5-2 Device

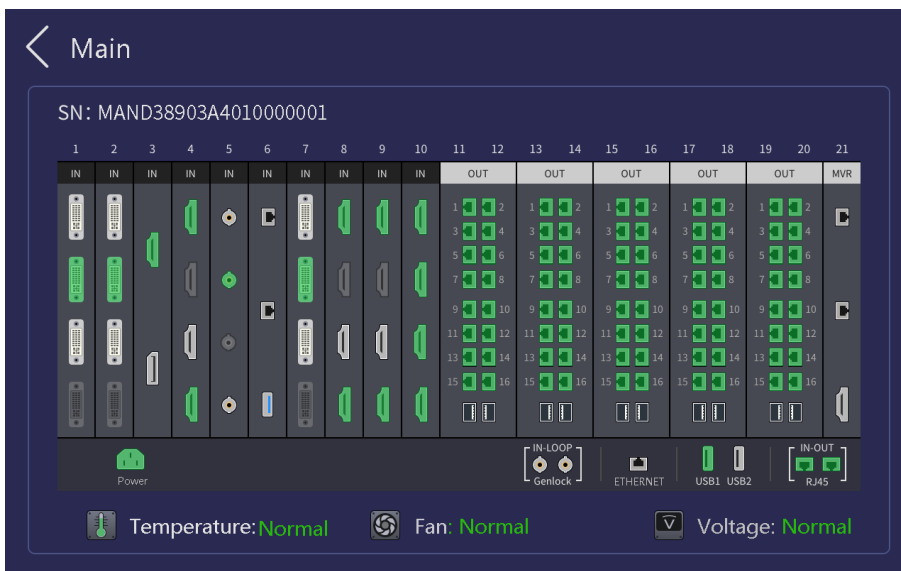

You can view the device serial number (SN) and the connection statuses of all connectors.

- Green connector: The connector is connected normally.
- White connector: The connector is not connected yet.
- Gray connector: The connector is unavailable.

Below the connector area, the device temperature, fan and power statuses are displayed.

5.2 Multiviewer

View the input and screen monitoring information.

Figure 5-3 Multiviewer



5.3 Settings

Set the device network mode, other advanced properties, and view the firmware version.

5.3.1 Communication Settings

Set the network parameters for the device.

Figure 5-4 Communication

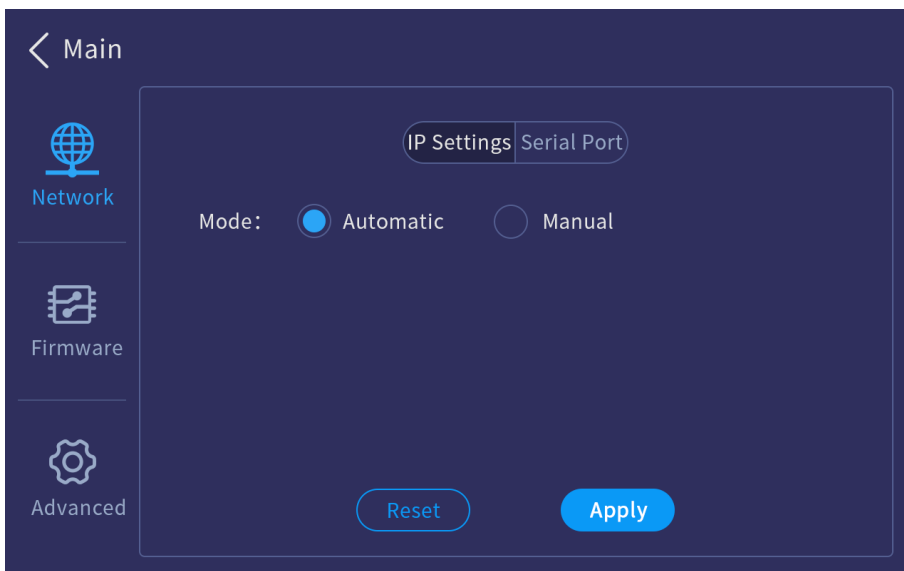

IP Settings

Set to obtain an IP address automatically or manually. When a router or switch is used, it is recommended you select the **Automatic** option. The device IP address will be assigned by the router or switch. When the **Manual** option is selected, you must set the device IP address, subnet mask and gateway.

Figure 5-5 IP settings

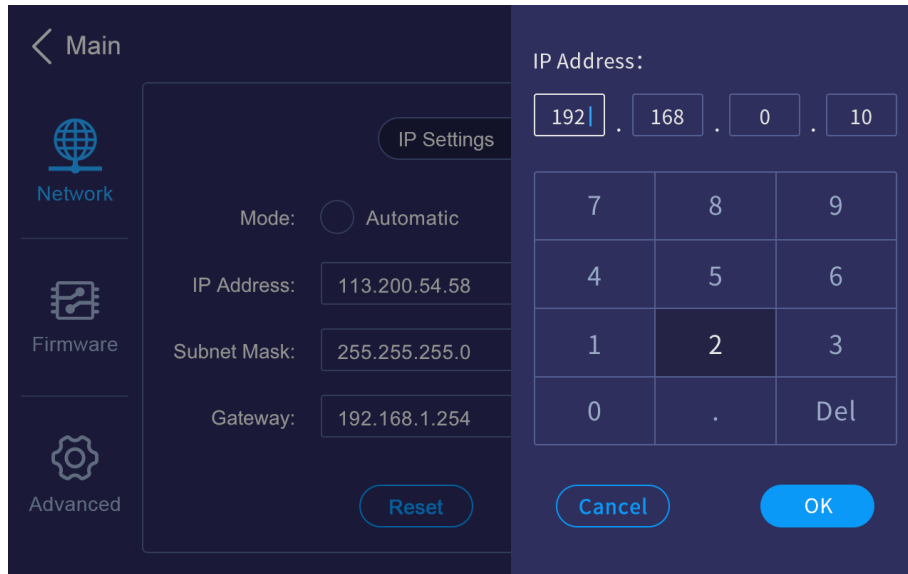

Note:

When you select to obtain the IP address manually, the IP addresses of both the device and control PC must be on the same network segment.

Serial Port Settings

Set the baud rate, data bits, stop bits and other related information for the RS232 serial port.

Figure 5-6 Serial port settings

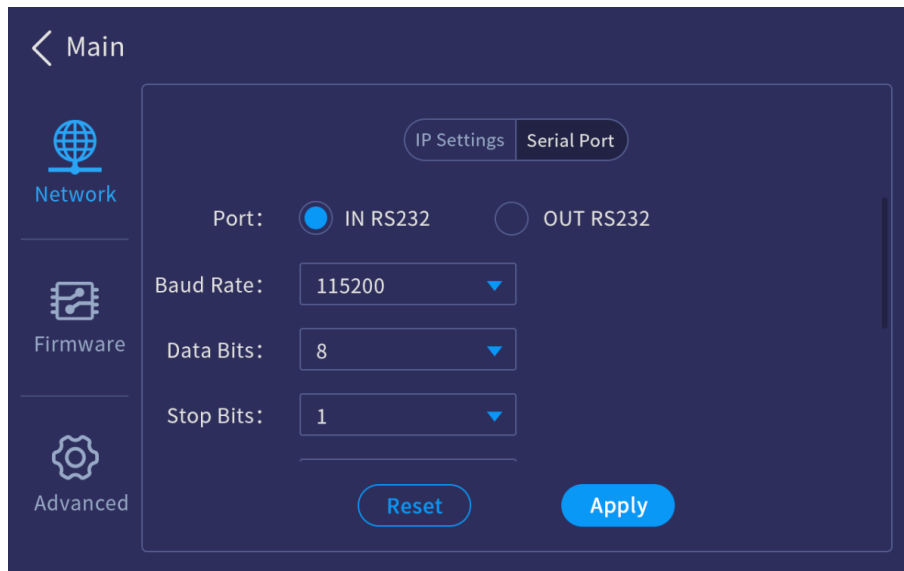

5.3.2 Firmware Version

View the versions of all cards.

Figure 5-7 Firmware version

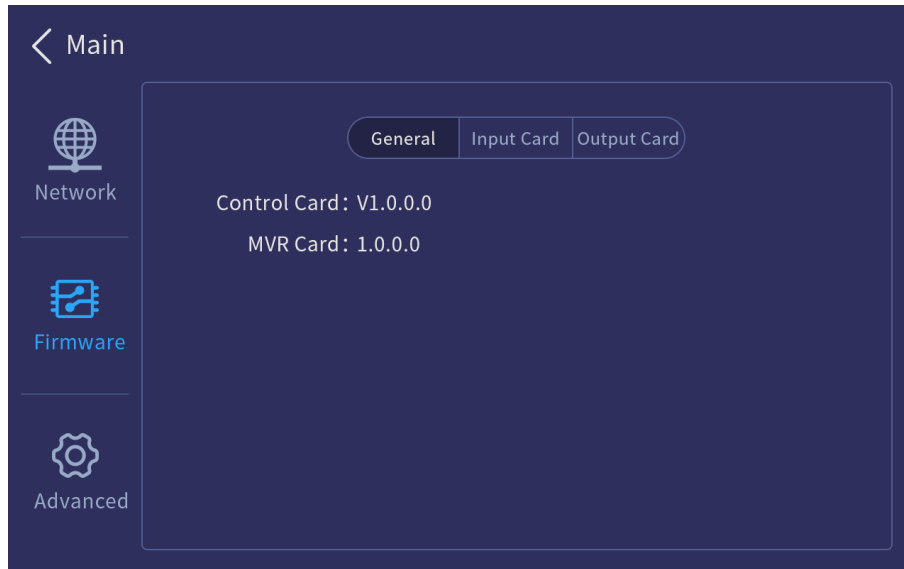

5.3.3 Advanced Settings

The advanced settings include the device general settings, factory reset, firmware update and USB import and export.

Select **Advanced** to enter the advanced setting screen.

Figure 5-8 Advanced settings



General Settings

Select **General** and you can perform the following operations.

- **Return to Home:** Set the period time during which the system stays at the current screen before returning to the home screen automatically when there is no operation performed. The default value is **60s** and the value range is **0s** to **3600s** and **Never**.
Never: The system always stays at the current screen and will never return to the home screen.
- **LCD Brightness:** Set the device screen brightness.

Factory Reset

Clear the data stored in the device, and reset the device settings to factory defaults.

Figure 5-9 Factory reset

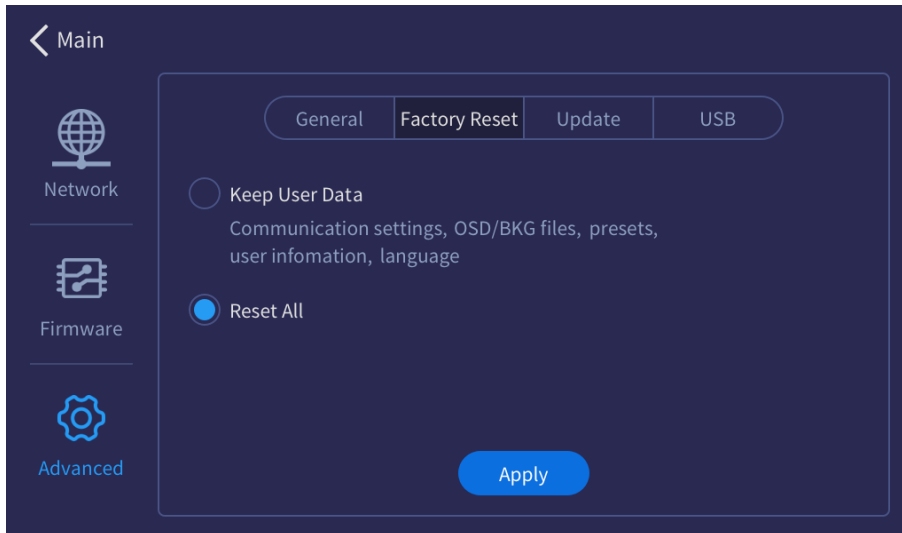

- **Keep User Data:** When you reset the device, the following information will still be kept in the system, including the communication settings, OSD and BKG files, presets, user information and UI language settings. Other parameters restore to default.
- **Reset All:** Reset all the parameters to factory defaults.

When you select **Reset All**, the language settings screen will be displayed on the device LCD screen and Web page after the device is restarted. Select the desired language and click **OK** to complete the language settings.

Figure 5-10 LCD screen

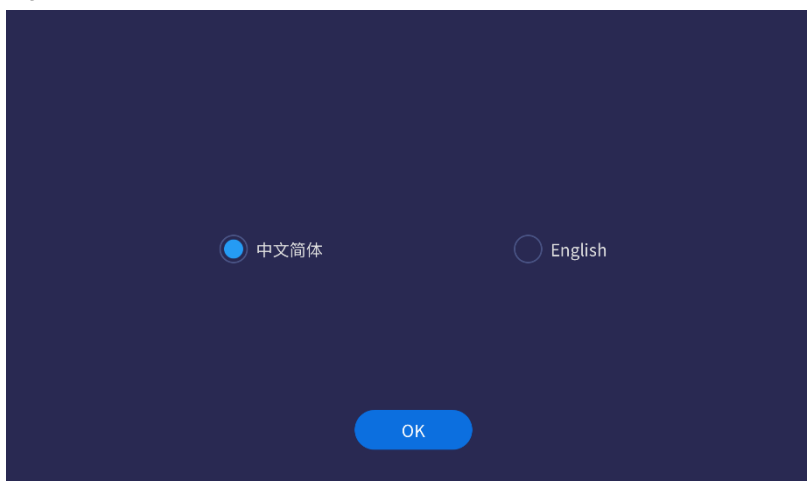
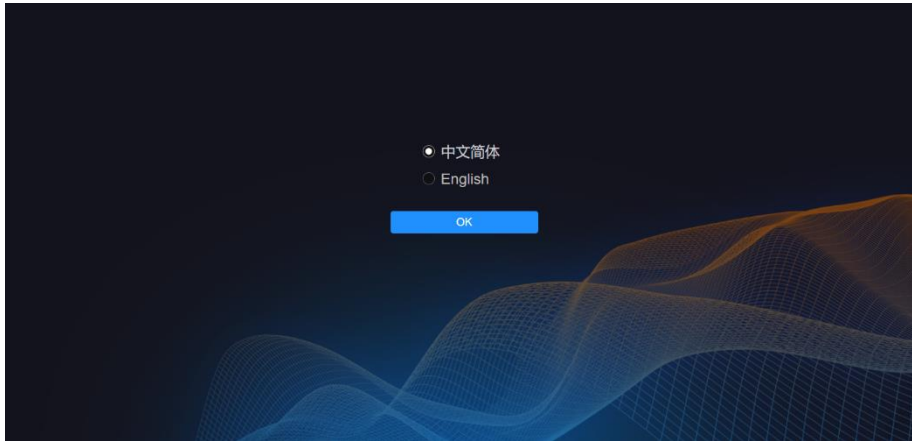

Figure 5-11 Web page

**Note:**

The LCD screen of the H2 will not display the language settings after the reset.

Firmware Update

Update the firmware using a USB drive. Make sure the update file is stored in the root directory of the USB drive before you update the firmware, and then insert the USB drive into the USB port on the H_Control card.

Step 1 Go to **Settings > Advanced > Update** to enter the firmware update screen.

Figure 5-12 Firmware update

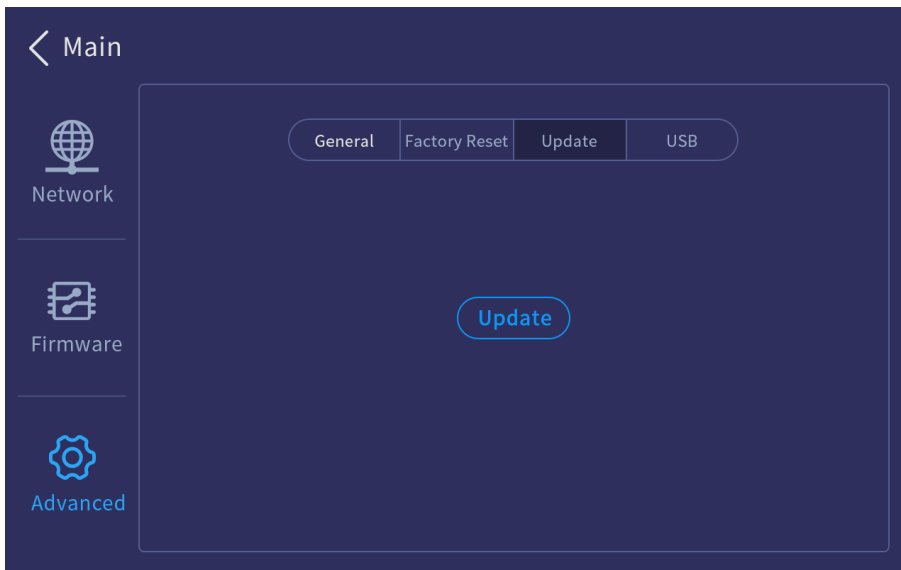

The system will automatically read the USB drive and detect the update file in the USB drive.

Step 2 Select the update file and click **OK** to start the update.

Figure 5-13 Select update file

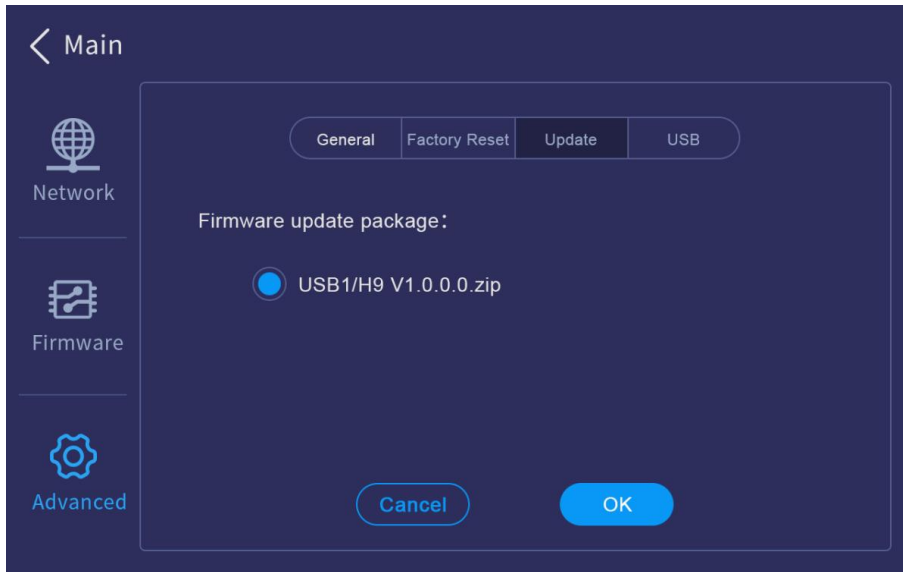

Step 3 When the message "**Updated successfully**" appears, click **Close** to restart the system.

USB Import and Export

The H series supports importing and exporting the device data using a USB drive, which will greatly facilitate the new device configuration in the future.

Figure 5-14 Import and export device data using a USB drive

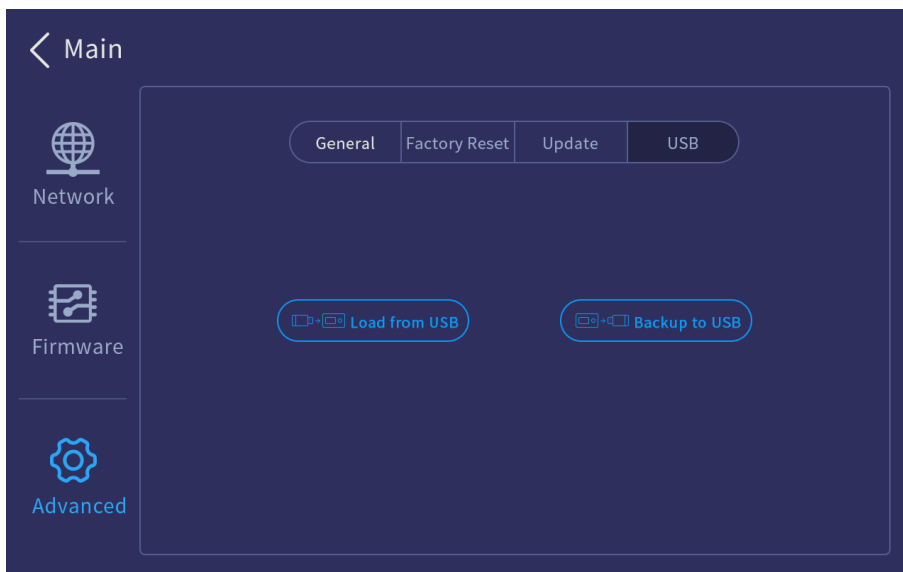

- Load from USB: Import the data from a USB drive.
- Backup to USB: Export the device data to a USB drive for backup.

5.4 Language

Change the UI language. The H series currently supports English and Simplified Chinese.

Figure 5-15 Changing language

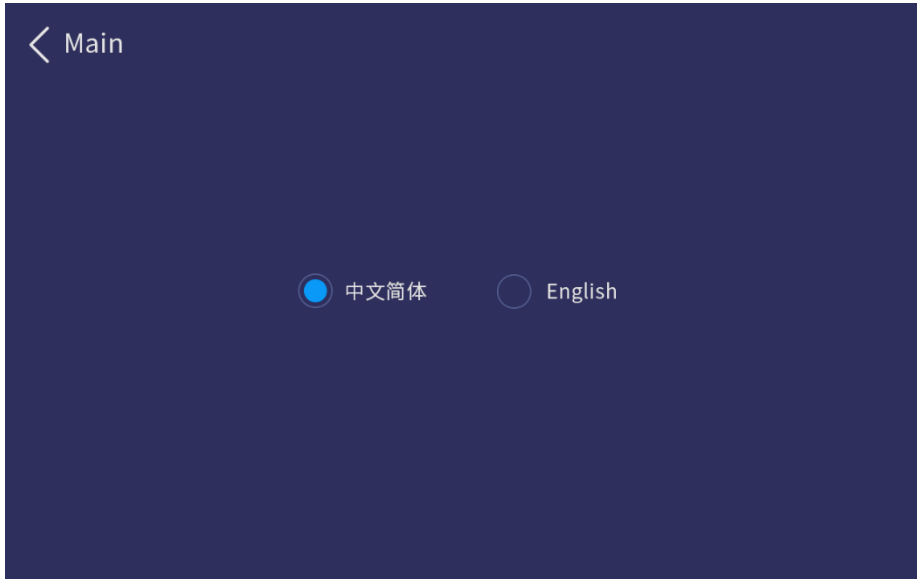

Notes:

Switching the device front panel UI language will simultaneously switch the Web page UI language.

The H2 does not support UI language switching via the front panel menu. If you need to switch the language, set it on the Web page.

5.5 About Us

View the device hardware version, company website (www.novastar.tech) and email address (support@novastar.tech).

Figure 5-16 About us

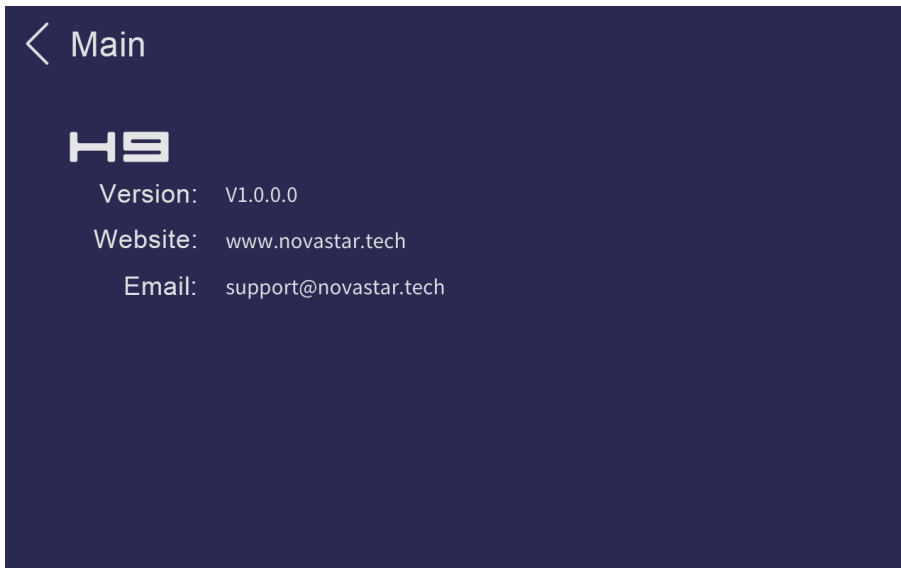

6 Web Introduction

- On the main user interface of the Web page, click  at the top right to save the configuration data to your local hard drive for future use.
- Click the drop-down arrow in the language area to change both the device front panel and Web UI language.
- Click the user name and select **Log Out** to end access to the system.

6.1 Screen Configuration

After you log in to the Web page, the screen configuration page is displayed by default. On this page, you can perform the operations such as changing the screen structure, renaming the screen, setting the test pattern as well as adjusting the output color.

Figure 6-1 Screen configuration

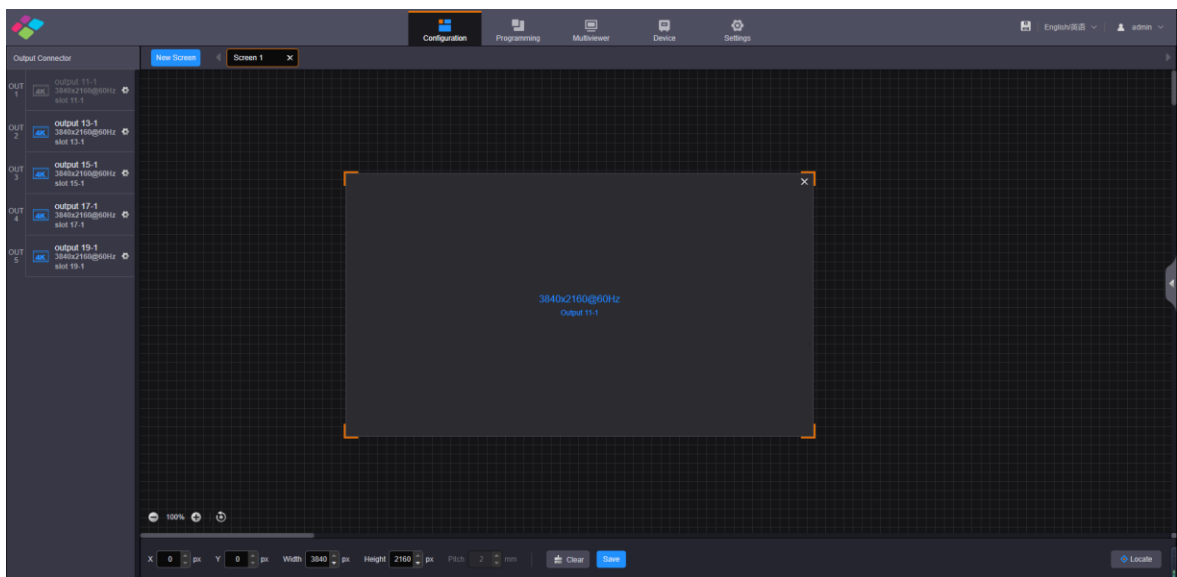

Output Cropping

At the bottom of this page, you can set the cropping of each output area.

Figure 6-2 Output cropping

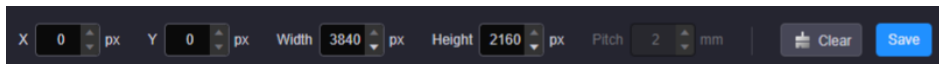

- X: Set the horizontal initial position for the cropping. The default value is 0 and the reference point for the cropping is the top left corner of the current output image.
- Y: Set the vertical initial position for the cropping. The default value is 0 and the reference point for the cropping is the top left corner of the current output image.
- Width: Set the width of the cropped area. The range is 64 to the width of the output image. The default value is the width of the current output image.
- Height: Set the height of the cropped area. The range is 64 to the height of the output image. The default value is the height of the current output image.
- Click **Clear** to clear the screen and screen configuration.
- Click **Save** to complete and save the screen configuration.

Output Locating

On the screen configurations page, click **Locate** at the bottom right, and then the location information appears on the loaded screen. This function provides convenience for adjusting the screen structure and screen configurations.

When the LED 4K sending card is used, to use the output locating function, you must enable the mapping function in NovaLCT and use the receiving cards that support the mapping function.

Note:

For related receiving card information, please visit NovaStar official website or contact our technical support staff.

Screen Configuration Parameters

On the screen configuration page, click  at the right edge to expand the screen parameter settings pane.

Figure 6-3 Screen configuration parameters



The screenshot shows the 'Basic Info' tab of the screen configuration interface. It includes the following settings:

- Name:** Screen 1 (8/15 characters)
- Rows:** 2
- Columns:** 2
- LCD Bezel Compensation:**
 - LCD Bezel Compensation
 - H Spacing:** 0 (-200, 200)
 - V Spacing:** 0 (-200, 200)
- 3D:**
 - 3D
 - Turning on 3D mode halves output capacity.
 - 3D Format:** Side-by-Side (selected), Top-and-Bottom
 - Eye Priority:** Right Eye (selected), Left Eye
 - Right Eye Start:** 960 DP
- 3D Emitter:**
 - Enable Third-Party Emitter
 - Signal Delay:** 7 ms, 0 us
- Reset** button

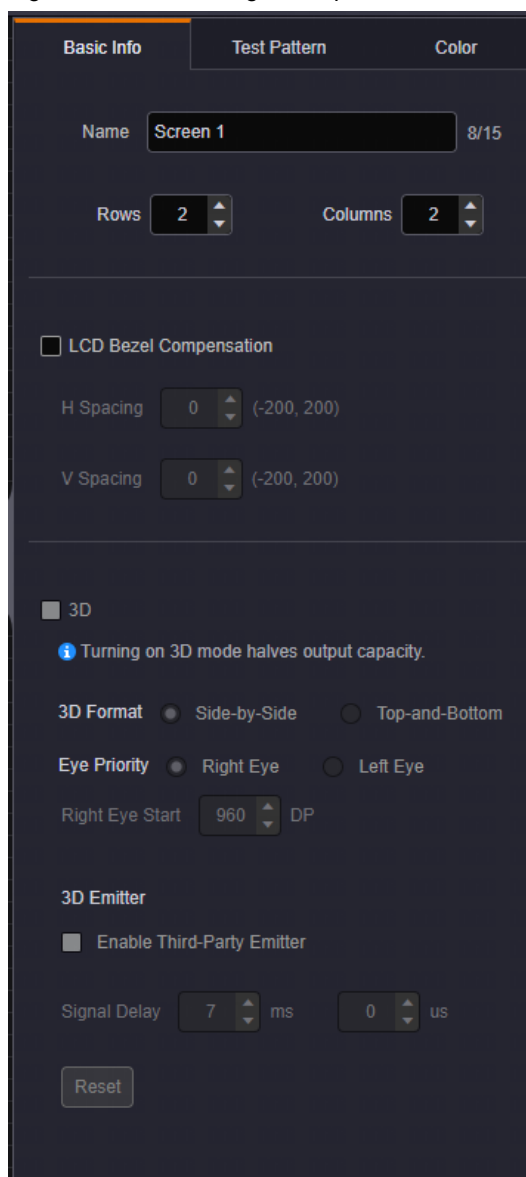
Table 6-1 Screen configuration parameters

Function	Parameter	Description
Basic Info	Name	Give a proper name to the screen for easy management. The screen name supports up to 15 Chinese characters, English letters, numbers, spaces, underscores and hyphens, and cannot be all spaces.
	Rows and columns	Set the row and column quantities to change the screen structure.
	3D	Set 3D-related parameters to provide users with the 3D visual experience. For detailed settings, please refer to 3D Settings on Web .
	Phase Offset	Set the time difference between the reference input clock and the feedback input. Before you enable the phase offset function, please enable the Genlock function first. <ol style="list-style-type: none"> Go to Settings > Other and check the box in front of Enable Genlock to enable the Genlock function. Click Configuration and then select the target screen Click  at the right side of the page to open the screen parameter settings pane. Click Basic Info. Check the box in front of Enable Genlock Phase Offset to enable the function. Drag the slider below Phase Offset and view the real-time recording image, and stop the dragging when you are satisfied with the output image to complete the phase offset settings.
Test Pattern	Test pattern	Test patterns are used to check the connection between the output connectors and the LED screen and check whether the display is normal. <ul style="list-style-type: none"> Select or deselect Enable to open or close the test pattern. Spacing: Set the width of gradient color or the space between test lines. This parameter is configurable when the test pattern is not a pure color. Speed: Set the moving speed of the test lines. This parameter is configurable when the test pattern has lines. Brightness: Set the brightness of the test patterns on the LED screen.
Color	Mode	Four display modes are provided for different user needs. The options are Standard, Document, Conference and Video .
	Eye saver mode	Turn on or turn off the eye saver mode for the Web page.
	Contrast	Contrast is the ratio of the luminance of the brightest color to that of the darkest color. Generally, the higher the contrast, the more clearer and colorful the image is. On the contrary, the entire image becomes gloomy. Contrast affects the exposure level of the entire image. It makes the bright part brighter and the dark part darker. The value range is 0 to 100, and it defaults to 50 .
	Brightness	Brightness is the shading of lights in the image. When the brightness increases, viewers will be dazzled. When the brightness decreases, the image becomes dark. The value range is 0 to 100, and it defaults to 50 .
	Saturation	Adjust the colorfulness of the output image. The value range is 0 to 100, and it defaults to 50 .
	Hue	Set the relative degree of how bright or dark the output image is. The value range is -180 to +180, and it defaults to 0 .
	Color Temperature	Adjust the cool or warm degree of the output image. The lower the

Function	Parameter	Description
		temperature, the warmer (redder) the image is. The higher the temperature, the colder (bluer) the image is.
	Gamma	Gamma: Set the Gamma for the output image. The value range is 0.25 to 4.00, and it defaults to 1.00 .
	HDR	<p>HDR is the abbreviation for High-Dynamic Range. HDR function can greatly enhance the display image quality, allowing for a more clear and vivid image when the device is used together with NovaStar A8s/A10s receiving cards.</p> <p>Select HDR to enable the HDR function.</p> <ul style="list-style-type: none"> • Format: Select the format of the current HDR source. HDR10 and HLG are both supported. HDR10 is selected by default. • Peak Screen Brightness: Adjust the screen brightness under normal operation. The value ranges from 100 to 10000 and defaults to 1000. • Ambient Illuminance: Display the ambient illuminance. The value ranges from 0 to 200 and defaults to 30. • Low Grayscale Mode: Adjust the screen image grayscale. The value ranges from 0 to 50 and defaults to 15.

Output Connectors

Click  next to the output connector to expand the output connector settings pane where you can set the following parameters.

Figure 6-4 Output connector parameters

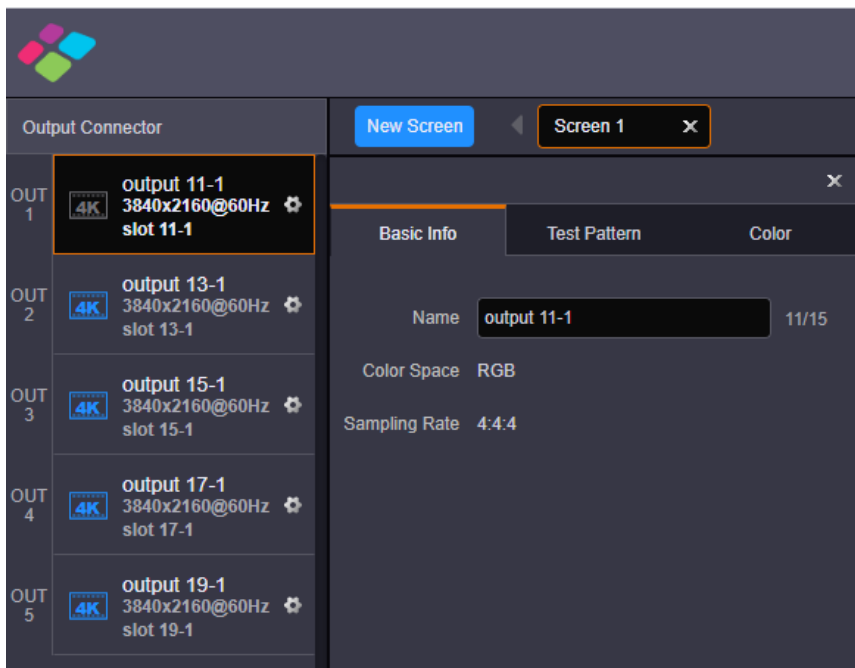

Table 6-2 Output connector parameters

Function	Parameter	Description
Basic Info	Name	Give a proper name to the output connector for easy management. The connector name supports up to 15 Chinese characters, English letters, numbers, spaces, underscores and hyphens, and cannot be all spaces.
	Color Space/ Sampling Rate	Display the color space and sampling rate of the output connector, which can be set on the Device page.

Function	Parameter	Description
Test Pattern	Test pattern	<p>Test patterns are used to check the connection between the output connectors and the LED screen and check whether the display is normal.</p> <ul style="list-style-type: none"> • Select or deselect Enable to open or close the test pattern. • Spacing: Set the width of gradient color or the space between test lines. This parameter is configurable when the test pattern is not a pure color. • Speed: Set the moving speed of the test lines. This parameter is configurable when the test pattern has lines. • Brightness: Set the brightness of the test patterns on the LED screen.
Color	Contrast	<p>Contrast is the ratio of the luminance of the brightest color to that of the darkest color. Generally, the higher the contrast, the more clearer and colorful the image is. On the contrary, the entire image becomes gloomy. Contrast affects the exposure level of the entire image. It makes the bright part brighter and the dark part darker.</p> <p>The value range is 0 to 100, and it defaults to 50.</p>
	Brightness	<p>Brightness is the shading of lights in the image. When the brightness increases, viewers will be dazzled. When the brightness decreases, the image becomes dark.</p> <p>The value range is 0 to 100, and it defaults to 50.</p>
	Saturation	<p>Adjust the colorfulness of the output image. The value range is 0 to 100, and it defaults to 50.</p>
	Hue	<p>Set the relative degree of how bright or dark the output image is. The value range is -180 to $+180$, and it defaults to 0.</p>
	Color Temperature	<p>Adjust the cool or warm degree of the output image. The lower the temperature, the warmer (redder) the image is. The higher the temperature, the colder (bluer) the image is.</p>
	Gamma	<p>Gamma: Set the Gamma for the output image. The value range is 0.25 to 4.00, and it defaults to 1.00.</p>





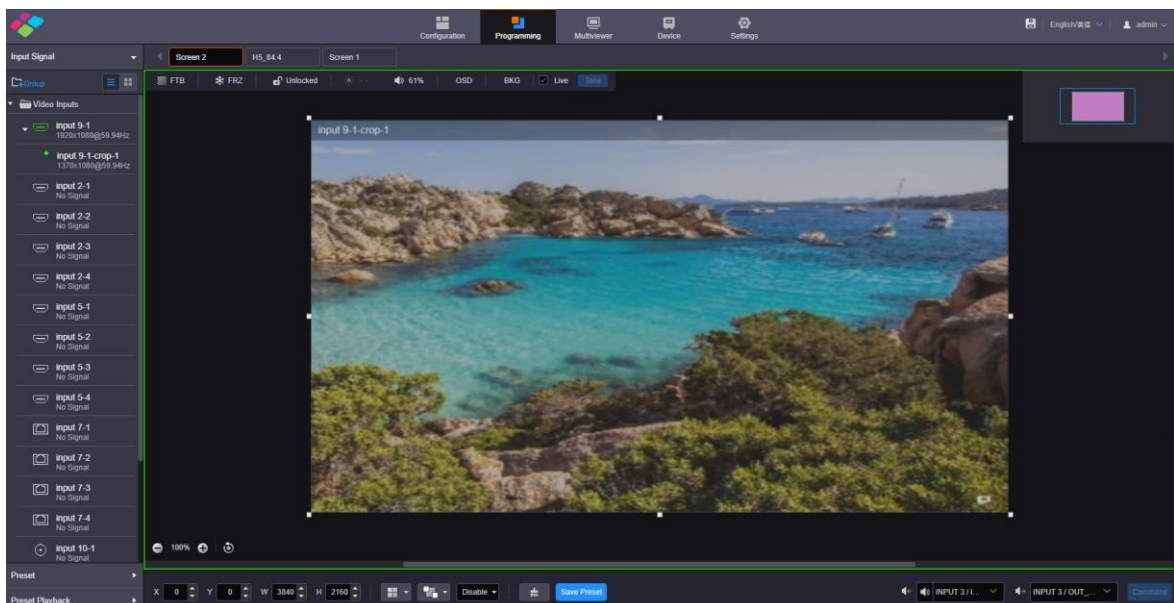

6.2 Programming

Click the **Programming** tab on the top to enter the programming page where you can perform the operations such as adding layers and BKG, cropping the input source, setting the preset and preset playback.

Figure 6-5 Programming



Button and Icon Descriptions

- : Zoom out the layer editing area.
- : Zoom in the layer editing area.
- : Display all the layers in the editing area in a perfect way, so that all the layers can be viewed completely.
- FTB: If the icon is highlighted, the output image will fade to black; otherwise, the output image will be displayed normally.
- FRZ: If the icon is highlighted, the current frame of the output image is frozen and the layer image cannot be edited; otherwise, the output image is not frozen.
- : Lock the editing area, and layer editing is prohibited.
- : Unlock the editing area.
- : Adjust the output image brightness.
- Live: Turn on this function to display the layer editing process on the LED screen in real time. Turn off this function to not display the editing process on the LED screen, and click the **Pre-Edit** button if you want to display the output image on the LED screen.
- : Undo the last operation. This button is available in pre-edit mode only.
- Pre-Edit: When the **Live** function is turned off, click this button to display the output image on the LED screen.

6.3 Multiviewer

Click the **Multiviewer** tab on the top to enter the monitoring page. Select the **Screen** or **Input** tab on the left, and then click and drag the desired screens or input sources to the monitoring editing area on the right. After the editing, you can go to Multiviewer on the LCD screen on the device front panel to view the monitoring information.

Figure 6-6 Multiviewer editing

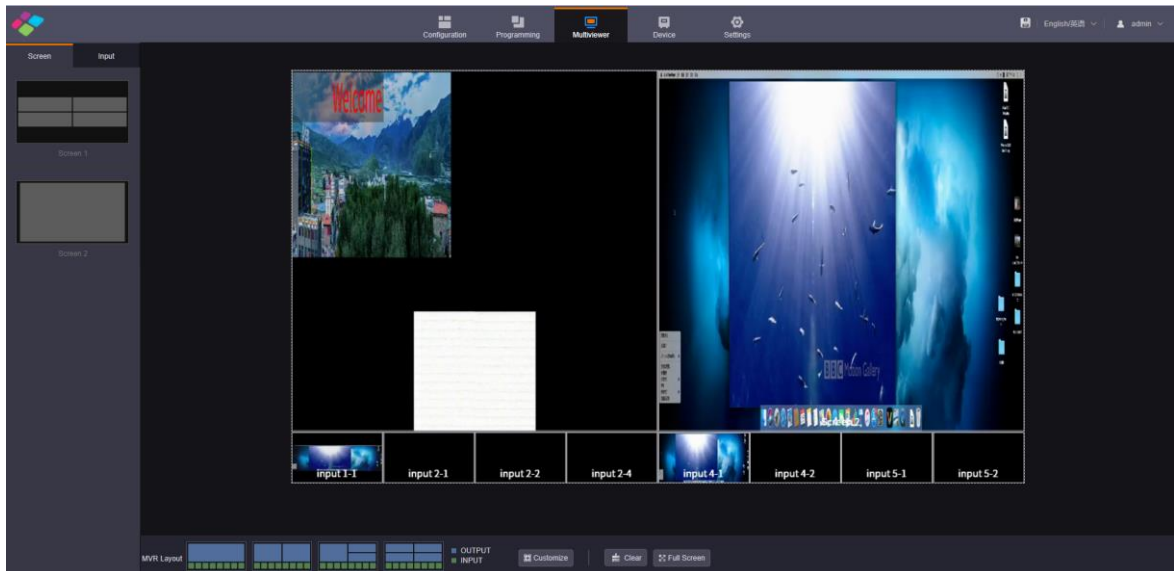

- Screen: Display all the output images of the screens.
- Input: Display all the input source images. Select **View inputs with signals** and the system only displays the input sources that are accessed with signals.
- MVR Layout: 4 layouts are provided for quick arrangement.
- Customize: Add new custom layouts.

- Clear: Clear all the MVR windows.
- Full Screen: Make the selected MVR window display in full screen.

Set MVR Properties

On the Multiviewer page, select an MVR window and click  at the top right of the window to expand the MVR property settings pane.

Figure 6-7 MVR property settings



- Display Name: Enable or disable the display of the MVR window name. When enabled, the name color can be set.
- Border: Set the color of the MVR window border by adjusting the R, G and B values individually. Set the width of the MVR window border.

After the settings, click **Apply** to save and apply the settings.

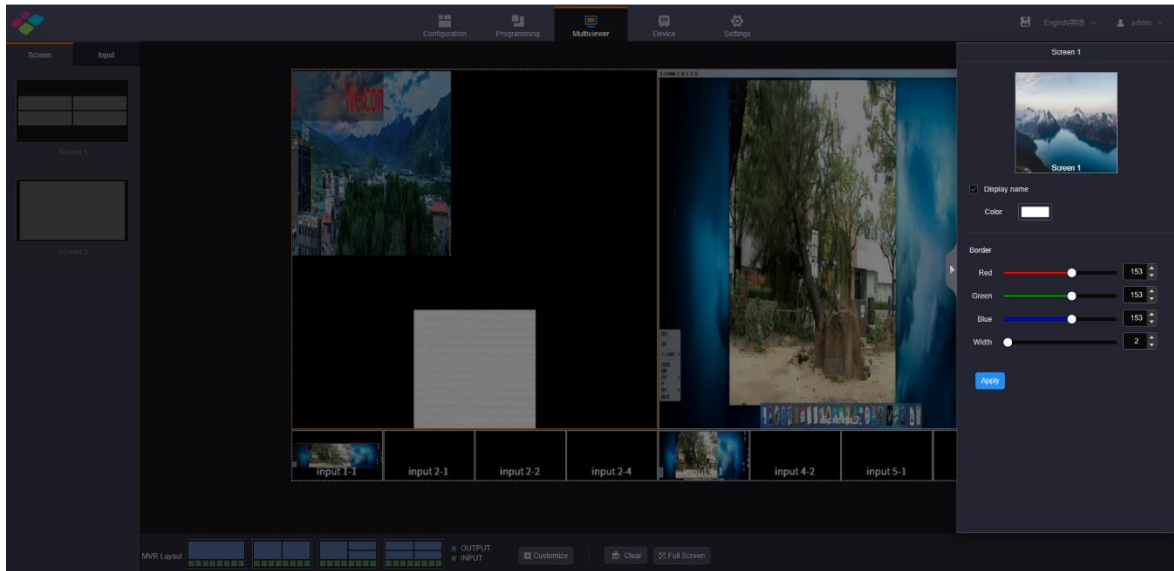
6.4 Device

Click the **Device** tab on the top to enter the device page where you can view the input or output card statuses and device running status. If the device fails, check the health status of each module by clicking **Self-Test** on this page. If the fan fails, click the drop-down arrow in the fan status area to check which fan fails exactly.

Figure 6-8 Device

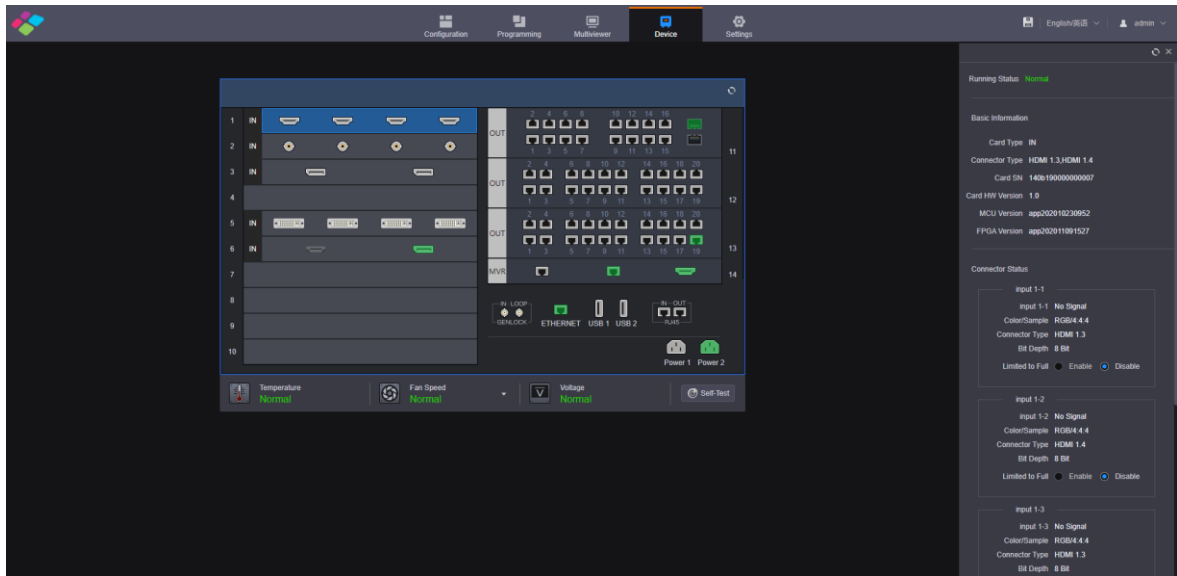

- The connector in green is connected.
- The connector in white is not connected, or the connected device fails.
- The connector in gray is unavailable.
- Self-Test: Diagnose the device and send the test result to NovaStar's technical support staffs for confirming and fixing the problems as soon as possible.

Input Card

Click an input card to view the input card type, connector type, card version, card SN and connector status and so on.

- Running status: Display the input card status.
 - Normal: The input card is normal and can be used.
 - Abnormal: The input card is abnormal and cannot be used.
- Basic Information: View the basic information of the input card, including the card type, connector type, SN and version.
- Connector Status: View the input resolution of each connector, the color space and sampling rate of the input source, the input connector type and input source bit depth, which are read by the system automatically and cannot be changed.
 - Connector status shows you the input signal status, color space and sampling rate, input connector type, input source bit depth which are all read automatically and cannot be changed.
 - Limited to Full: Convert an RGB limited input source to an RGB full range source for more precise video processing.
 - Disable: Turn off the limited to full converting function.
 - Enable: Turn on the limited to full converting function. It is recommended you turn on the function when the accessed input source has a limited color range.
- Connector Settings: Select the single link or dual link mode for the input connector.

Figure 6-9 Connector settings

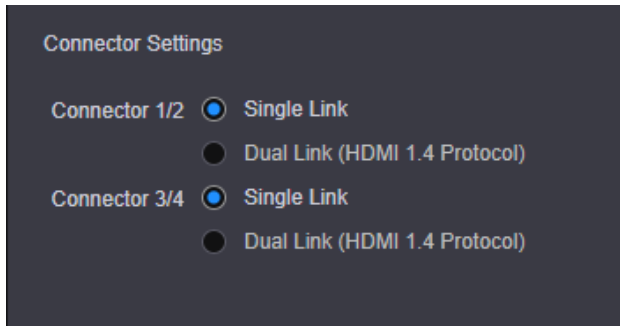

When you set the input connector 1/2 to dual link mode, connector 1 is unavailable and connector 2 is used as a dual link connector. The input connector 3/4 follows the same rule.

When the input card is an H_1xHDMI2.0+1xDP1.2 input card that supports only one input each time, you can set select HDMI 2.0 or DP 1.2 connector here.

- When the input card is an H_2xRJ45 IP input card, you need to set the working mode for two Ethernet ports. The working mode is independent by default, and you need to set the IP address, subnet mask and other information for each Ethernet port independently.

IP Input Card

- When the H_2x RJ45 IP input card is used, you need to configure the working mode of the two Ethernet ports. The default working mode is **Independent**, and you need to set the IP settings of each Ethernet port.
- The H_2xRJ45 IP input card supports three kinds of decoding modes, including **16x 200W**, **8x 400W**, **4x 800W** and **Mosaic**. The decoding capability of the IP input card cannot be lower than the specification of the connected IP camera.
 - 16x 200W: Single card decoding capability: up to 16x 1080p or other lower-resolutions, and up to 16x layers
 - 8x 400W: Single card decoding capability: up to 8x 4Kx1K or other lower-resolutions, and up to 8x layers
 - 4x 800W: Single card decoding capability: up to 4x 4Kx2K or other lower-resolutions, and up to 4x layers
 - Mosaic: Single card decoding capability: up to 1x 64-channel D1 source mosaic for image partition display

Figure 6-10 H_2xRJ45 IP input card configuration

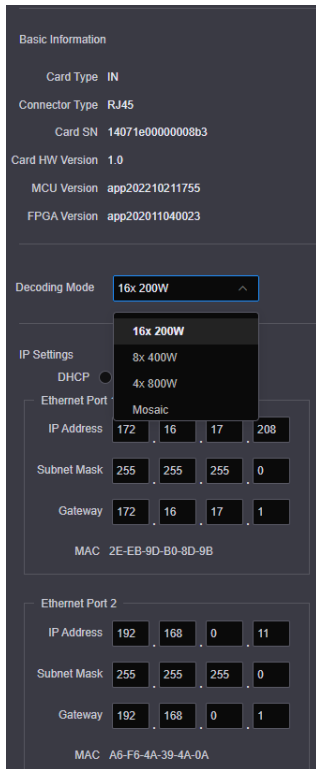

H_2xFiber Input Card

OPT 1 and OPT 2 are used for primary inputs. OPT 3 serves as the backup of OPT 1, while OPT 4 serves as the backup of OPT 2.

Click an H_2xfiber input card to view the basic information of the card, input mode and input source information.

Figure 6-11 H_2xfiber input card parameters

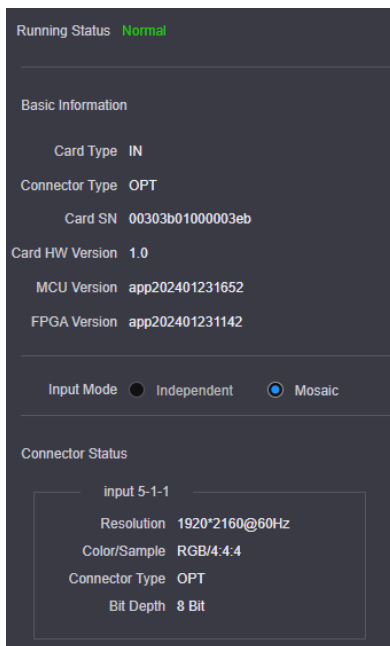

- Running status: Display the current input card status.
 - Normal: The input card is normal and can be used.
 - Abnormal: The input card is abnormal and cannot be used.

- **Basic Information:** View the basic information of the input card, including the card type, connector type, SN and version.
- **Input Mode:** Set the input mode of the OPT port. The supported options include **Independent** and **Mosaic**.
 - **Independent:** The input source connected to each OPT port can be used as an independent source. You can use the desired source to add a layer.
 - **Mosaic:** The input sources connected to each H_2xfiber input card are used for one mosaic source, and the input source connected to each port cannot be used independently.
- **Connector Status:** View the input source name, the input resolution of each connector, the color space and sampling rate of the input source, the input connector type and input source bit depth.
- **Set the input source mosaic.**
 - a. On the **Device** page, click an H_2xfiber input card and set the input mode to **Mosaic**.
 - b. Click the **Programming** tab on the top to enter the programming page.
In the **Video Inputs** area on the left, the input source name will change to "input x-MOSAIC", whereas "x" indicates the card slot number.
 - c. Click a mosaic source in the **Video Inputs** area on the left and drag it to the editing area to add a layer.

Figure 6-12 Add mosaic source layers

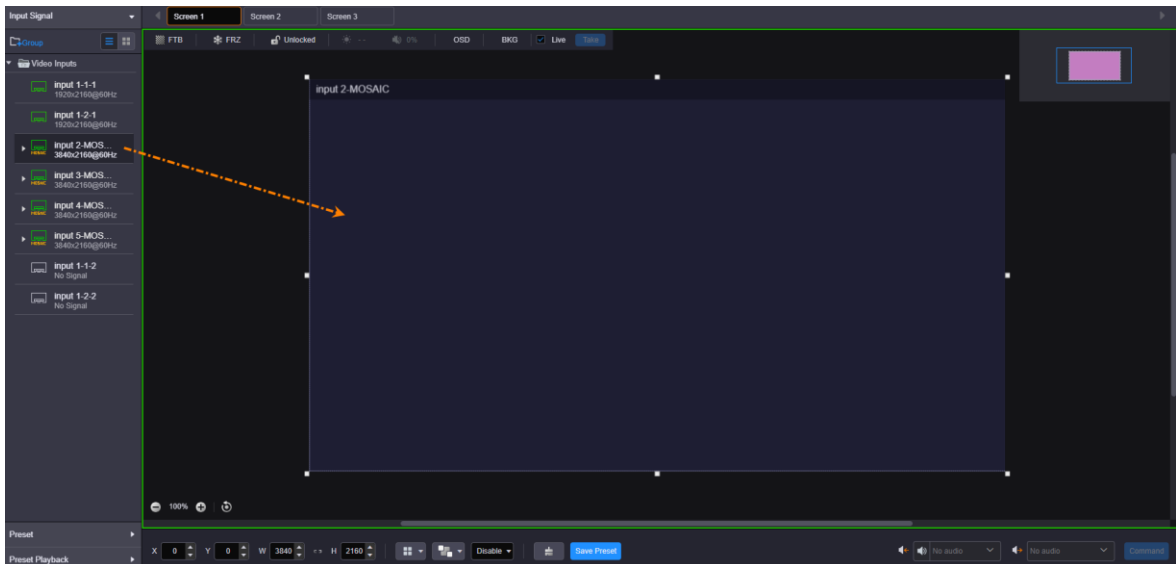











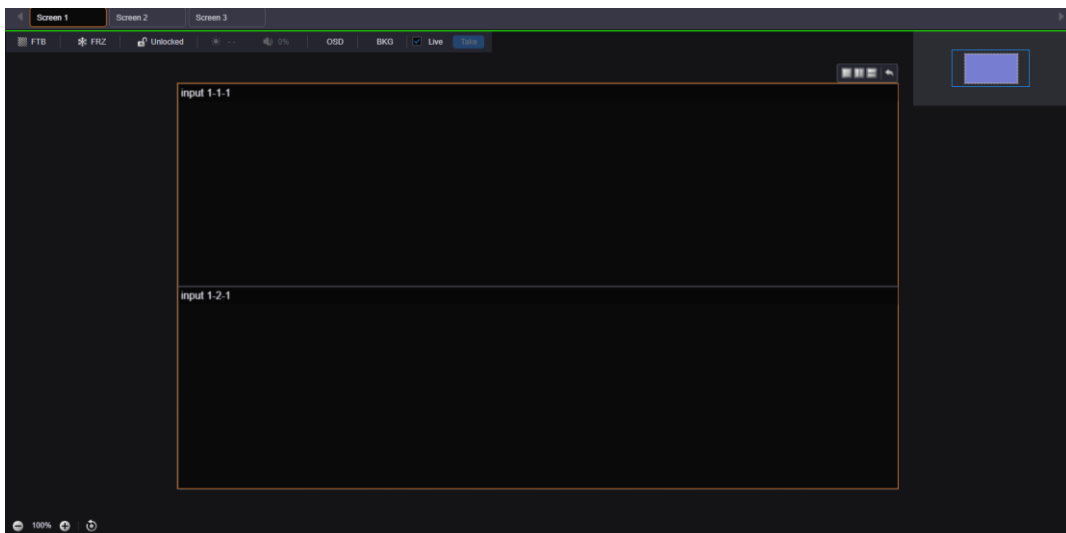

- d. Select a layer and click  in the layer menu to enter the layer layout settings page.

Figure 6-13 Edit mosaic layout





The SL source supports eight mosaic layout options, including , , , , , , , , and .

The DL source supports three mosaic layout options, including ,  and .

- e. In the **Video Inputs** area on the left, click a mosaic source to expand its sub inputs. Click and drag the inputs to the mosaic layout.

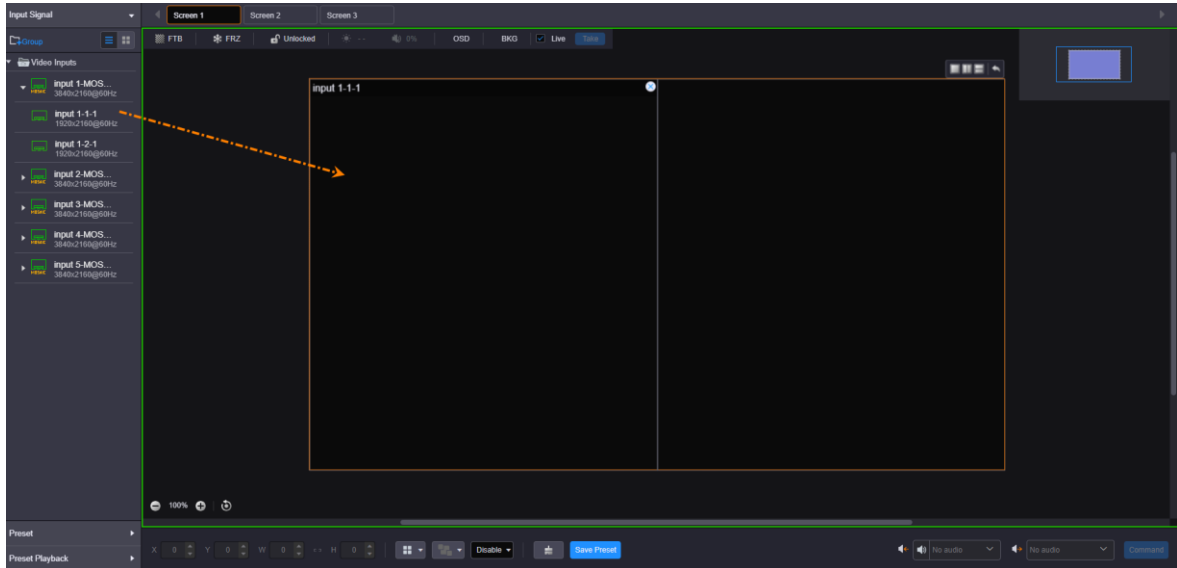
Figure 6-14 Add inputs



If you want to change the input, click and drag a new input to the corresponding layout area and the original one will be overwritten, or click  at the top right corner of the desired layout area to delete the added input and drag a new one.

- f. After all the inputs are added, click  at the top right corner to complete the mosaic layout settings, and the mosaic layer image will be displayed.

Output Card



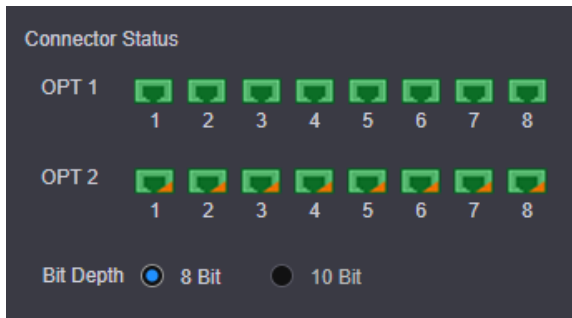

- Video output card
 - Running status: Display the current output card status.
 - Normal: The card is connected normally and can be used for output.
 - Abnormal: The card fails and cannot be used for output.
 - Basic Information: View the basic information of the output card, including the card type, connector type, serial number and version numbers.
 - Connector Status: View the output resolution and connector type and set the output color space, sampling rate and bit depth.
 - Connector Settings: For the DVI and HDMI output cards, you can configure the single-link or dual-link output.
 - Single link: All four connectors are used for output.
 - Dual link: Connectors 2 and 4 are used for main output. Connector 1 copies the output on connector 2, while connector 3 copies the output on connector 4.
- H_16xRJ45+2xfiber sending card and H_20xRJ45 sending card
 - Running status: Display the current output card status.
 - Normal: The card is connected normally and can be used for output.
 - Abnormal: The card fails and cannot be used for output.
 - Basic Information: View the basic information of the output card, including the card type, connector type, serial number and version numbers.

- Connector Status: Set the output bit depth. The supported options are 8-bit and 10-bit.
If the backend device is connected to the OPT port on the H_16xRJ45+2xfiber sending card, the Ethernet port status of the backend device can be displayed on this page.

Figure 6-15 Ethernet port status





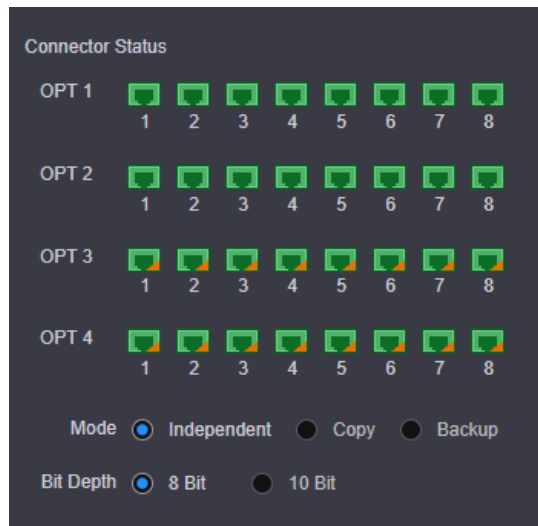

Status descriptions:

- : The Ethernet port on the backend device is connected.
 - : The Ethernet port on the backend device serves as the backup port. When  at the bottom right flashes, the backup function is enabled.
 - : The Ethernet port on the backend device is not connected.
- H_4xfiber sending card
 - Running status: Display the current output card status.
Normal: The card is connected normally and can be used for output.
Abnormal: The card fails and cannot be used for output.
 - Basic Information: View the basic information of the output card, including the card type, connector type, serial number and version number.
 - Connector Status: View the status of the Ethernet port on the backend device connected to the OPT port on the H_4xfiber sending card, and set the connector mode and the output bit depth.

Ethernet port status:



Status descriptions

- : The Ethernet port on the backend device is connected.
- : The Ethernet port on the backend device serves as the backup port. When  at the bottom right flashes, the backup function is enabled.
- : The Ethernet port on the backend device is not connected.

The supported connector modes include **Independent**, **Copy** and **Backup**. The supported bit depth options include 8-bit and 10-bit.

Independent: Four OPT ports are all used for output and have the same loading capacity. The loading capacity of one port is equal to that of 8 Ethernet ports.

Copy: OPT 1 and OPT 2 are used for main output. OPT 3 copies the output on OPT 1, while OPT 4 copies the output on OPT 2.

Backup: OPT 1 and OPT 2 are used for main output. OPT 3 serves as the backup of OPT 1, while OPT 4 serves as the backup of OPT 2.

MRV Card

The MVR card is the preview card.

- **Running Status:** Display the MVR card status.
 - Normal: The card is connected normally and can be used for output.
 - Abnormal: The card fails and cannot be used for output.
- **Basic Information:** View the basic information of the MVR card, including the card type, connector type, serial number and version number.
- **Network Settings:** When Ethernet ports are used for output, you need to set the IP addresses of two Ethernet ports and the URLs for the screen and input monitoring.
 - Mode: Set the working mode of the Ethernet port. The working mode is independent by default, and you need to set the IP address, subnet mask and other information for each Ethernet port independently.
 - IP address: Set the IP address for each Ethernet port.
 - Subnet Mask: Set the subnet mask.
 - Gateway: Set the gateway.
 - URL: Set the URL paths and ports for the input and screen monitoring.

Control Card

View the basic information of the control card and AUX card, including the running statuses, serial numbers and hardware version numbers.

6.5 Settings

Click the **Settings** tab on the top to enter the settings page.

Figure 6-16 Settings

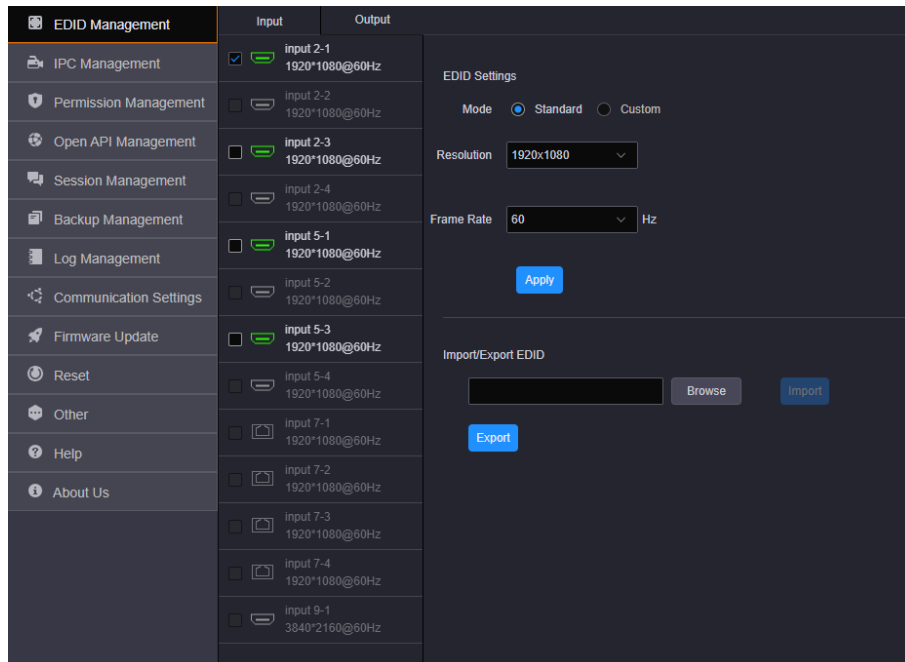

6.5.1 EDID Management

Set the input and output resolution. You can set the input or output connector resolution through the following four ways.

- Standard resolution

Select an input or output resolution from the drop-down list next to **Standard Resolution**.

- Custom resolution

Set the width, height and frame rate for the input or output connectors.

- Advanced Settings

Under custom mode, you can select **Advanced** to enable the advanced EDID settings function. The parameters for advanced settings are shown as follows.

Figure 6-17 EDID management

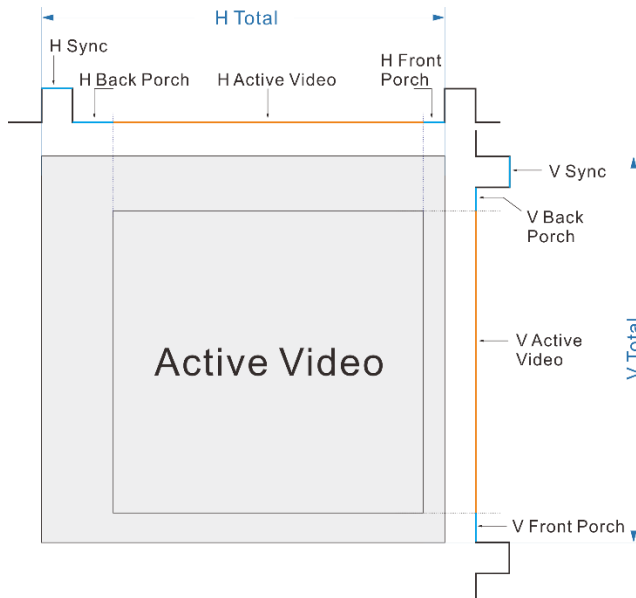

- Import EDID

Click **Browse** to open the window where you can select the desired EDID configuration file, and import it for quick configuration.

Notes:

The system supports simultaneous EDID settings for multiple input and output connectors of the same type and version.

The H_16xRJ45+2xfiber sending card, H_20xRJ45 sending card and H_4xfiber sending card support custom resolution settings only.

The VGA, CVBS and SDI connectors do not support resolution and frame rate settings.

6.5.2 IPC Management

6.5.2.1 Add IPC Signal

When an IP input is accessed, you need to manage and configure the IPC signal source.

- Step 1 On the **Settings** page, click **IPC Management** on the left to enter the IPC management page.

Figure 6-18 IPC management

No.	IPC Specification	Signal Name	IP	Channels	Management
1	200W	ipc-omvf	10.40.84.43	1	Edit Delete
2	200W	84.55	10.40.84.55	1	Edit Delete
3	200W	1	132.111.255.3	1	Edit Delete
4	200W	nvr	10.40.84.121	14	Edit Delete

Step 2 Click **Create** to open the **Add Signal Source** window.

Figure 6-19 Add IPC / NVR signal sources

Step 3 Enter a name for the added signal.

Step 4 Click the drop-down list next to **IPC Specification** to select the specification of the added signal. The supported options include **200W**, **400W** and **800W**.

When you select the IPC specification, it must match the resolution of the IP camera. If the selected specification is lower than the resolution of the connected IP camera, the camera image cannot be decoded.

Step 5 Click the drop-down list next to **Config Method** to select the input source protocol for the IPC card.

GB28181, RTSP and ONVIF protocols are supported currently.

When you select different protocols, you need to check the parameters of the added camera and then fill in the configuration parameters.

- **Config Method - RTSP**

Real Time Streaming Protocol (RTSP) is a protocol that provides a framework for real-time media data transfer at the application level. The protocol focuses on connecting and controlling the multi-data delivery sessions on lines of time synchronization for continuous media like video and audio.

When you set the config method to RTSP, you must obtain the URL of the RTSP service and the matched user name and password in advance, and then fill the necessary parameters accordingly on the Web page.

Note:

When you select Dahua, Hikvision, Uniview, Jovision or Xiongmai, the URL address is obtained automatically by the system. You only need to enter the IP address, user name and password.

Figure 6-20 RTSP

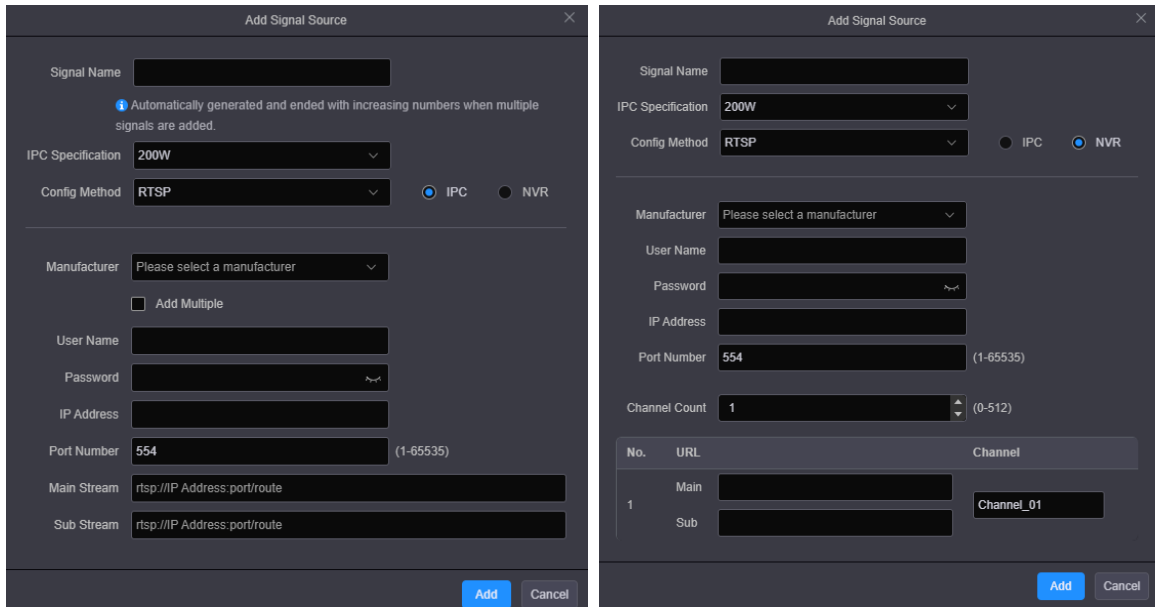

- Config Method - ONVIF

Open Network Video Interface Forum (ONVIF) is a global and open industry forum with the goal of facilitating the development and use of a global open standard for the interface of physical IP-based security products. ONVIF creates a standard for how IP products within video surveillance and other physical security areas can communicate with each other.

When you set the config method to ONVIF, you can select to add the camera information manually or by auto scanning.

- Manual

When you set the adding method to **Manual**, you must enter the camera IP address and the user name and password for logging in camera.

When you check the box next to **Add Multiple**, you must enter the start and end IP addresses of the camera.

Figure 6-21 Add manually

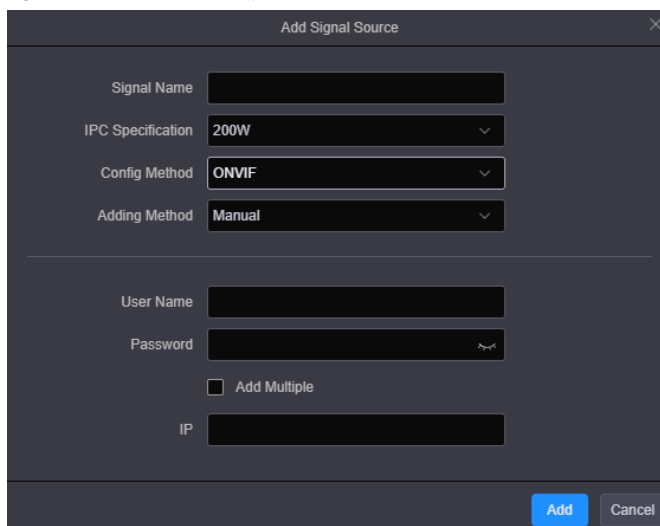

- Auto scan

When you set the adding method to **Auto scan**, the system will scan and list all the cameras on the current network segment.

Figure 6-22 Auto scan

The screenshot shows the 'Add Signal Source' dialog box. At the top, there is a 'Signal Name' input field. Below it, a note states: 'Automatically generated and ended with increasing numbers when multiple signals are added.' The 'IPC Specification' is set to 'Please select', 'Config Method' is 'ONVIF', and 'Adding Method' is 'Auto scan'. A section titled 'Cameras' contains a list of cameras with a 'Select All' checkbox. To the right of this list is an 'Activate' section with 'User Name' and 'Password' input fields. At the bottom right, there are 'Add' and 'Cancel' buttons.

Check the box in front of the desired camera, and enter the user name and password for logging in camera. When adding multiple cameras, you must set the same user name and password for the selected cameras in advance.

- Config Method - GB28181

GB28181 is a standard that is widely used in security-related industries, such as police, traffic police and other government projects.

When you set the config method to GB28181, you must obtain the related information of the accessed monitoring system and the IP settings of the device in advance, and then fill the related parameters accordingly on the Web page.

Figure 6-23 GB28181

The screenshot shows the 'Add Signal Source' dialog box with 'Config Method' set to 'GB28181' and 'IPC Specification' set to '200W'. Below these are several input fields: 'Platform ID', 'Platform SIP Port', 'Platform IP Address', 'Local ID', 'Local SIP Port', 'Local IP Address', 'SIP ID', and 'SIP Port' (which is pre-filled with '6000'). At the bottom right, there are 'Add' and 'Cancel' buttons.

Step 6 Click **Add** to complete adding the cameras.

After the video sources are added successfully, the cameras and their IP address will be listed.

Figure 6-24 IPC signal source list

No.	IPC Specification	Signal Name	IP	Channels	Management
1	200W	ipc-onvif	10.40.84.43	1	Edit Delete
2	200W	84.55	10.40.84.55	1	Edit Delete
3	200W	1	132.111.255.3	1	Edit Delete
4	200W	nvr	10.40.84.121	14	Edit Delete

6.5.2.2 Import Multiple IPC Sources

The H series supports batch importing and exporting of IPC sources.

- Step 1 Click **Download Template** at the top right corner to download the template for importing IPC sources to your local computer.
- Step 2 Fill in the relevant information according to the requirements in the template.
- Step 3 Click **Batch Import** to import the IPC sources in the template to the system.

Note:

You can also export all the added IPC sources to your local computer for future use.

6.5.2.3 Add IPC Mosaic Source

You can mosaic multiple IP signal sources to realize customized image partition display.

Note:

Set the decoding mode to **Mosaic** in [IP Input Card](#) before you mosaic the IPC sources.

- Step 1 Click **Programming** to enter the layer editing page.
- Step 2 Click Mosaic Network Inputs in the Input Signal area.

The mosaic source named **Input x-1** appear under **Mosaic Network Inputs**, whereas **x** indicates the card slot number.

Note:

The Input x-1 mosaic source is an empty source and cannot be used to add a layer. After you have completed the operations in [Step 3](#) to [Step 5](#), the mosaic source can be used to add layers.

Figure 6-25 Mosaic network inputs

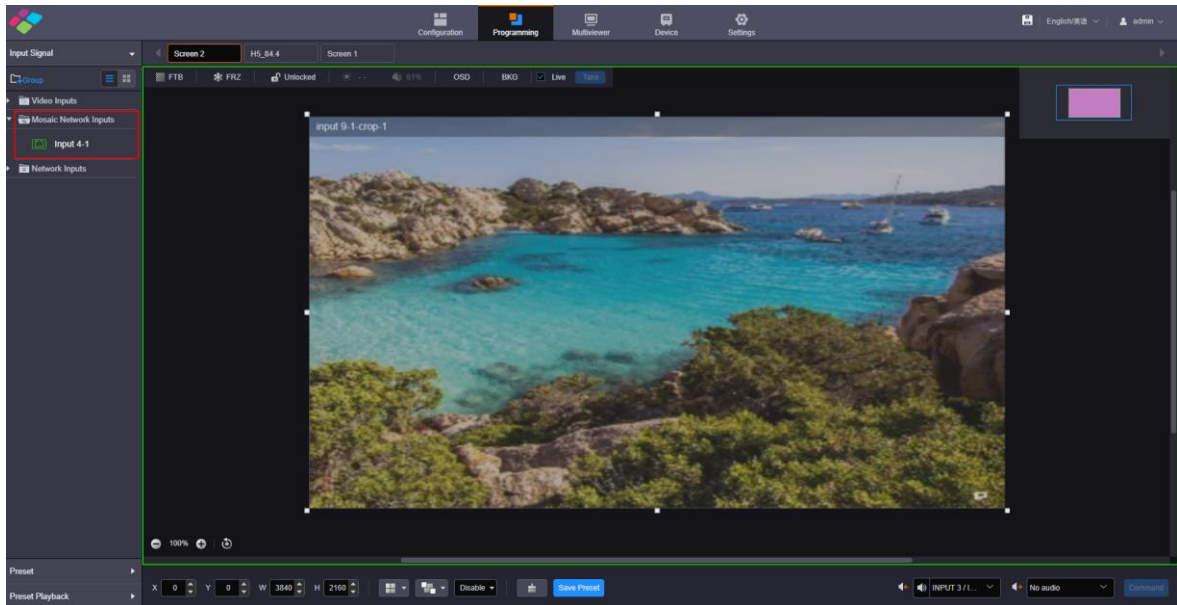

Step 3 Click the target input source and ... appears.

Step 4 Click ... to open the source operation menu.

Figure 6-26 Edit mosaic source

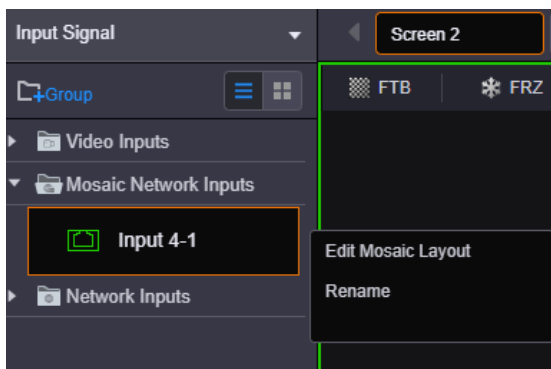

Step 5 Click **Edit Mosaic Layout** to open the layout editing window.

Step 4 Click **+ New** in the template list to create a new template.

Figure 6-27 Edit mosaic layout

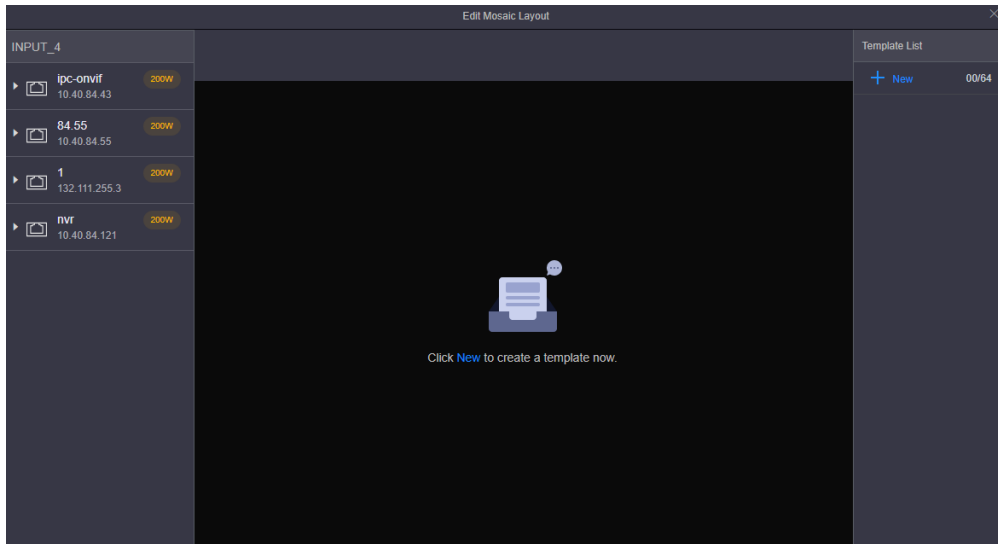

Step 5 Edit the layout.

1. Name the template and set the rows and columns (row \times column \leq 64).
2. Click and drag the signal sources to the mosaic source template.

Figure 6-28 Add sources

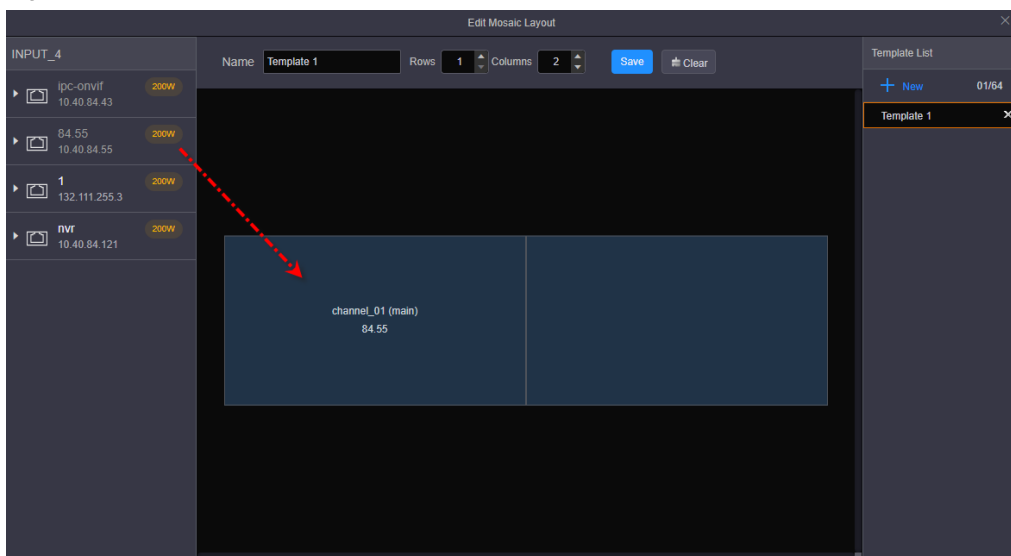

3. Click **Save** at the top to save the IPC mosaic source template settings.

After a template is saved, the new template is shown in the operation menu as shown below. You can use the mosaic source to add layers.

Figure 6-29 Mosaic source template

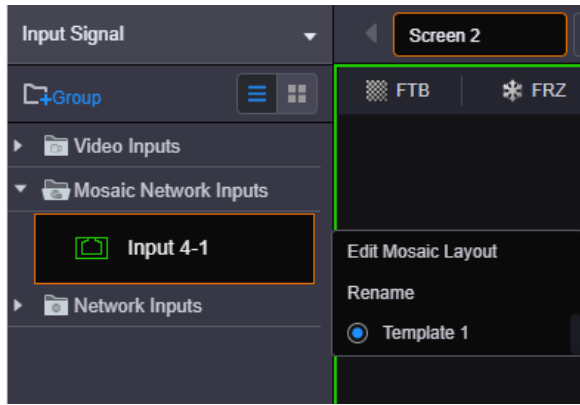

6.5.3 Permission Management

6.5.3.1 Role Management

The administrator is able to create permission collections and grant permissions to each user in the system through the role management function. This function also facilitates the fine control of user permissions. For adding new roles, please refer to 4.14 Manage Roles.

Figure 6-30 Role management



6.5.3.2 User Management

The H series supports multi-user collaboration at the same time. Only one user (admin) is created in the system by default. For adding new users, please refer to 4.15 Manage Users.

Figure 6-31 User management

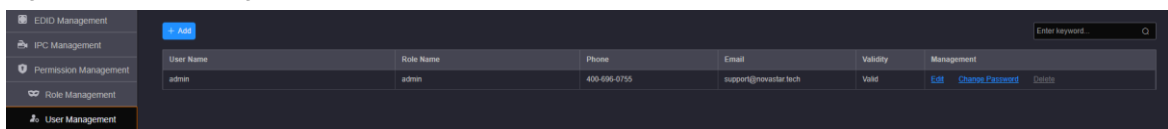

6.5.4 Open API Management

The H series provides the open API connector. The third-party developers can control video wall splicers through this connector.

- Step 1 Click **Open API Management** on the left to enter the open API management page.

Figure 6-32 Open API management

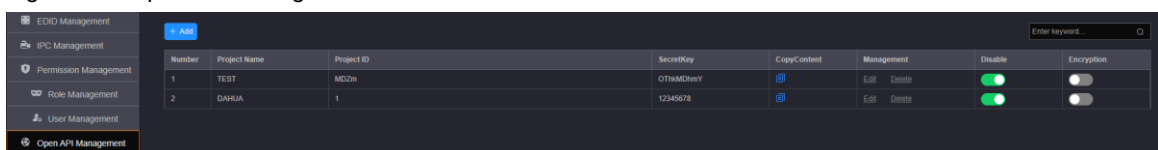

- Step 2 Click **Add** to add a new open API project.

Figure 6-33 Add open API-1

Step 3 Enter the name of the third-party control in the **Project Name** text box.

The system automatically generates a secret key and display it in the **Project Secret Key** text box. Click  to generate a new key.

Step 4 Click **OK** to complete the adding.

Figure 6-34 Add open API-2

Number	Project Name	Project ID	SecretKey	CopyContent	Management	Disable	Encryption
1	TEST	MD2m	0THMMDeY		Edit Delete	<input checked="" type="checkbox"/>	<input type="checkbox"/>
2	DAHUA	1	12345678		Edit Delete	<input checked="" type="checkbox"/>	<input type="checkbox"/>

After the API is added, the system automatically creates the project ID and the open API is enabled by default. When you need to transmit encrypted control commands, set the button in the column of **Encryption** to



Click  in the column of **Copy Content** to copy the project name, project ID and secret key information and send them to third-party developers.

When you no longer use the open API and need to delete the created open API project, set the button in the column of **Disable** to , and then click **Delete** in the column of **Management**.

6.5.5 Session Management

Click **Session Management** on the left to enter the session management page. You can view the relevant information of the current users in the system.

Figure 6-35 Session management

No.	Account	IP	Login Time	Last Time	Management
1	admin	10.241.10.105	2023-12-22 09:57:11	2023-12-22 09:57:14	
2	admin	10.40.90.56	2023-12-22 11:44:49	2023-12-22 11:44:55	
3	admin	10.241.10.167	2023-12-21 19:07:55	2023-12-22 11:18:05	

If the user has the permission to end the session for other users, click **End** to force other users to log out.

6.5.6 Backup Management

Click **Backup Management** on the left to enter the backup management page. You can save and export the configured device parameters as a configuration file for future use.

Figure 6-36 Backup management

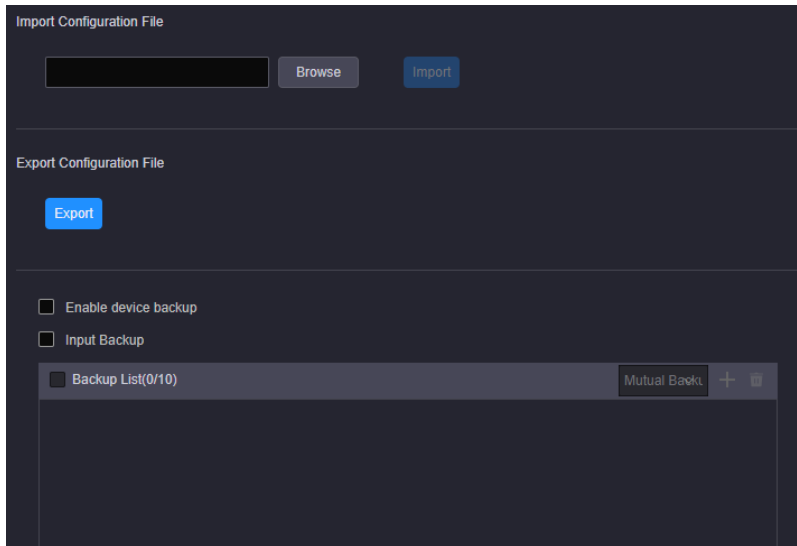

- Import Configuration File: Import the saved configuration file for quick screen configuration, color, EDID, layer, BKG, OSD, preset and preset playback settings.
- Export Configuration File: Click **Export** to export the device configuration parameters for future use.

Device Backup

The H series devices support both the backup between the devices of the same model and the backup between the sending cards on the same device. You must set the backup in NovaLCT by referring *NovaLCT User Manual*.

After configuring the backup in NovaLCT, check the box in front of **Enable device backup** to turn on the backup function.

Note:

The settings for the backup device and the backup sending card must be same as that of the primary device and primary sending card.

Input Backup

The H series devices support the input source backup function. If the input signal in use is abnormal or lost, the backup one will take over the job seamlessly to ensure the display not go black.

- Step 1 Click **Backup Management** on the left to enter the backup management page.
- Step 2 Check the box next to **Input Backup** to enable the input source backup function.
- Step 3 Select the desired backup relation. The options include **Mutual Backup** and **Primary and Backup**.
 - Mutual Backup: When one input source fails, the other one takes the job seamlessly; when the failed one resumes, it continues to work normally and the other does not work.
 - Primary and Backup: When the primary input source fails, the backup one takes the job seamlessly; when the primary one resumes, it continues to work normally and the backup one does not work.
- Step 4 Click  at the top right of the input backup list to add a new backup pair.

Figure 6-37 Add backup pairs-1



Step 5 Select two input sources respectively from the two drop-down lists to complete the adding of one backup pair.

Figure 6-38 Add backup pairs-2

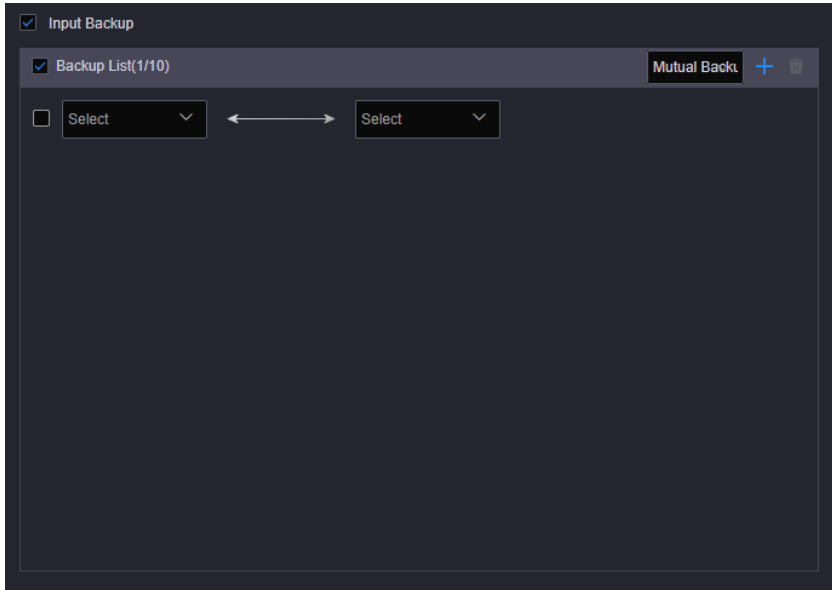
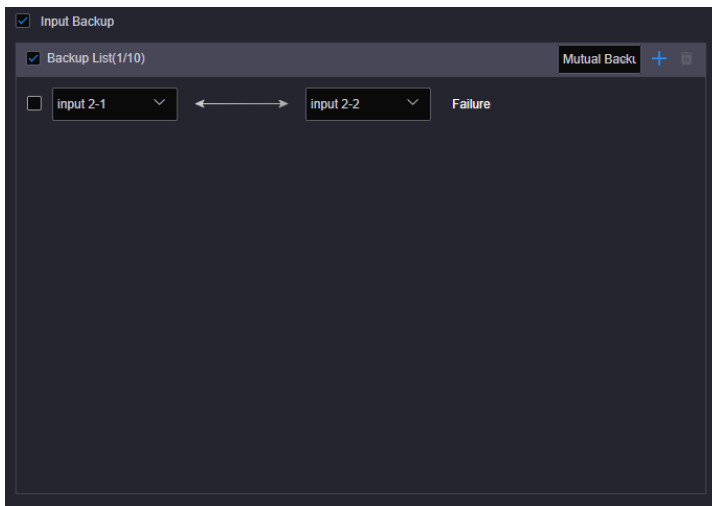

The system will automatically detect the status of the backup one and display the status next to the backup pair.

Step 6 Repeat [Step 3](#) and [Step 4](#) to add more backup pairs.

6.5.7 Log Management

You can view the login logs and operation logs for analyzing problems.

6.5.7.1 Login Logs

Go to **Log Management > Login Logs** to enter the login log management page. You can view the IP address, login time and login status of each user.

Figure 6-39 Login logs

No.	Account	IP	Type	Time	Description
1	admin	127.0.0.1	login	2023-06-15 17:58:09	user-admin login: success
2	admin	127.0.0.1	login	2023-06-15 17:59:21	user-admin login: success
3	admin	127.0.0.1	login	2023-06-16 08:45:22	user-admin login: fail
4	admin	127.0.0.1	login	2023-06-16 08:45:31	user-admin login: fail
5	admin	127.0.0.1	login	2023-06-16 08:45:37	user-admin login: fail
6	admin	127.0.0.1	login	2023-06-16 08:45:53	user-admin login: success
7	admin	127.0.0.1	login	2023-06-16 08:47:06	user-admin login: success
8	admin	127.0.0.1	login	2023-06-16 09:34:57	user-admin login: fail
9	admin	127.0.0.1	login	2023-06-16 09:35:01	user-admin login: success
10	admin	127.0.0.1	login	2023-06-16 10:01:13	user-admin login: success
11	admin	127.0.0.1	login	2023-06-16 10:19:02	user-admin login: success
12	admin	127.0.0.1	login	2023-06-16 11:30:49	user-admin login: fail
13	admin	127.0.0.1	login	2023-06-16 11:31:00	user-admin login: fail
14	admin	127.0.0.1	login	2023-06-16 11:35:36	user-admin login: fail
15	admin	127.0.0.1	login	2023-06-16 16:11:57	user-admin login: fail
16	admin	127.0.0.1	login	2023-06-16 16:13:05	user-admin login: fail
17	admin	127.0.0.1	login	2023-06-16 16:39:39	user-admin login: fail
18	admin	127.0.0.1	login	2023-06-16 16:39:48	user-admin login: success
19	admin	127.0.0.1	login	2023-06-16 16:44:55	user-admin login: fail
20	admin	127.0.0.1	login	2023-06-16 16:45:01	user-admin login: success

Query Logs

Select the start and end dates and click **Query** to query the login logs of the selected period.

Delete Logs

Click **Delete** to delete all the login logs.

6.5.7.2 Operation Logs

Go to **Log Management > Operation Logs** to enter the operation log management page. You can view the operation modules, operations, operation time and operation details of all the users.

Figure 6-40 Operation logs

No.	User	Module	Coming	Operation	Time	IP	Operation Details
1	admin	Device card	Device_Slot	edt	2023-11-23 10:23:34	10.40.84.244	{network: {mode: 1, 'ips': [{'ip': 10, 'ip1': 40, 'ip2': 84, 'ip3': 6}, {subnetMask: {subnetMask0: 255, 'subnetM...
2	admin	Device card	Device_Slot	edt	2023-11-23 14:30:59	10.40.84.155	{network: {mode: 1, 'ips': [{'ip': 10, 'ip1': 40, 'ip2': 84, 'ip3': 6}, {subnetMask: {subnetMask0: 255, 'subnetM...
3	admin	Device	Self_Check	edt	2023-11-23 15:58:11	10.40.84.155	operate success
4	admin	Device	Genlock	edt	2023-11-24 10:22:45	10.40.80.146	{genlockId: 0, 'enable': 0, 'type': 0, 'extSignal': 0, 'inputId': 25, 'deviceId': 0}
5	admin	Device	Genlock	edt	2023-11-24 10:22:46	10.40.80.146	{genlockId: 0, 'enable': 1, 'type': 0, 'extSignal': 0, 'inputId': 25, 'deviceId': 0}
6	admin	Device	Genlock	edt	2023-11-24 10:24:10	10.40.80.146	{genlockId: 0, 'enable': 1, 'type': 1, 'extSignal': 0, 'inputId': 24, 'deviceId': 0}
7	admin	Device	Genlock	edt	2023-11-24 10:24:12	10.40.80.146	{genlockId: 0, 'enable': 1, 'type': 0, 'extSignal': 0, 'inputId': 25, 'deviceId': 0}
8	admin	Device	Genlock	edt	2023-11-24 11:04:58	10.40.80.146	{genlockId: 0, 'enable': 1, 'type': 0, 'extSignal': 0, 'inputId': 32, 'deviceId': 0}
9	admin	Device	Genlock	edt	2023-11-27 11:43:03	10.40.91.165	{genlockId: 0, 'enable': 1, 'type': 0, 'extSignal': 0, 'inputId': 32, 'deviceId': 0}
10	admin	Device	Genlock	edt	2023-11-27 11:43:25	10.40.91.165	{genlockId: 0, 'enable': 1, 'type': 1, 'extSignal': 0, 'inputId': 32, 'deviceId': 0}
11	admin	Device card	Device_Slot	edt	2023-11-27 13:53:12	10.40.91.165	{slotId: 11, 'SenderColorDepth': 1, 'deviceId': 0}
12	admin	Device card	Device_Slot	edt	2023-11-27 13:58:18	10.40.91.165	{slotId: 11, 'SenderColorDepth': 0, 'deviceId': 0}
13	admin	Device	Device_COM	edt	2023-11-27 17:52:43	10.40.91.165	{comIn: {baudRate: 9600, 'dataBits': 8, 'stopBits': 1, 'parity': 0, 'waitTime': 200}, 'comOut: {baudRate: 9600, 'dat...
14	admin	Device	Device_Shutdown	edt	2023-11-28 10:25:51	10.40.84.155	{type: 0, 'deviceId': 0}
15	admin	Device	Device_Shutdown	edt	2023-11-28 11:27:33	10.40.84.60	{type: 0, 'deviceId': 0}
16	admin	Device card	Slot_Function	edt	2023-11-29 15:13:41	10.40.84.244	{slotId: 1, 'functions': [{id: 0, 'functionType': 0}], 'deviceId': 0}
17	admin	Device card	IPC_Mode	edt	2023-11-30 14:27:57	10.40.84.152	{slotId: 3, 'videoMode': 0, 'deviceId': 0}
18	admin	Device card	IPC_Mode	edt	2023-11-30 14:36:19	10.40.84.152	{slotId: 3, 'videoMode': 2, 'deviceId': 0}
19	admin	Device card	IPC_Mode	edt	2023-11-30 15:24:35	10.40.81.14	{slotId: 3, 'videoMode': 0, 'deviceId': 0}
20	admin	Device card	IPC_Mode	edt	2023-11-30 15:45:35	10.40.84.155	{slotId: 3, 'videoMode': 2, 'deviceId': 0}

Query Logs

Select the start and end dates and click **Query** to query the operation logs of the selected period.

Delete Logs

Click **Delete** to delete all the operation logs.

6.5.8 Communication Settings

Click **Communication Settings** on the left to complete the IP address and serial port settings.

Figure 6-41 Communication settings

MAC Address 54-b5-6c-02-e2-80

IP Settings

IP Mode Automatic Manual

IP Address 10 40 84 4

Subnet Mask 255 255 255 0

Gateway 10 40 84 1

Apply Reset

Serial Port Settings

Serial Port IN (RS232)

Baud Rate 9600

Data Bits 8

Stop Bits 1

Parity Bit None

Waiting Time 200 ms

Apply Reset

6.5.8.1 IP Settings

The IP address can be set manually or automatically.

It should be noted that the IP addresses of both the device and control PC must be on the same network segment, and the device IP address cannot be the same as that of the control PC. For example, if the IP address of the control PC is 192.168.0.100, the device IP address must be 192.168.0.X and the "X" cannot be 100.

The subnet mask and gateway of the device must be the same as that of the control PC.

6.5.8.2 Serial Port Settings

Set the serial port (COM IN) related parameters for a better connection with the central control device and device control through the central control device.

6.5.8.3 Set Serial Port Parameters

The H series devices support the control of other devices via the COM OUT port on the H_Control card. The serial port (COM OUT) is used to connect the controlled device. You need to obtain the serial port parameters of the controlled device before settings.

- Step 1 Click **Communication Settings** on the left to enter the communication settings page.
- Step 2 In the **Command Settings** area, set the serial port parameters.

Each serial port parameter must be the same as that of the controlled device.

Figure 6-42 Serial port parameters

Command Settings

Serial Port OUT(RS232)

Baud Rate: 9600

Data Bits: 8

Stop Bits: 1

Parity Bit: None

Waiting Time: 200 ms

Name	Command
No Data	

Apply Reset

Step 3 Click **Apply** to save and apply the settings.

6.5.8.4 Add Commands

Add the operation commands for the device.

Step 1 Click **+** at the top right corner of the command list to open the new command adding window.

Figure 6-43 Add new commands

New Command

Name: 0/16

Command: 0/1024

OK Cancel

Step 2 Enter a name for the added command.

Step 3 Enter the command code.

For the command code, you can refer to the command in the control protocol of the controlled device.

Step 4 Click **OK** to complete the adding.

Figure 6-44 Command added successfully

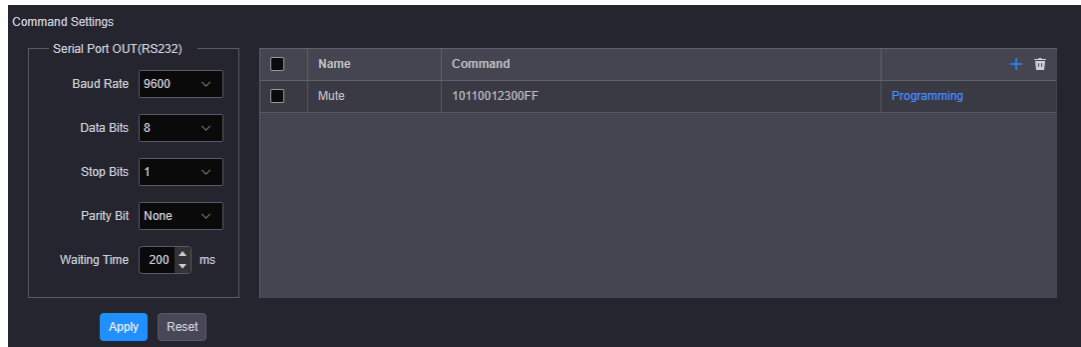

Step 5 Repeat [Step 1](#) to [Step 4](#) to add more commands.

6.5.8.5 Edit Commands

Step 1 In the command list, select the desired command and click **Programming** to open the command editing window.

Figure 6-45 Edit commands

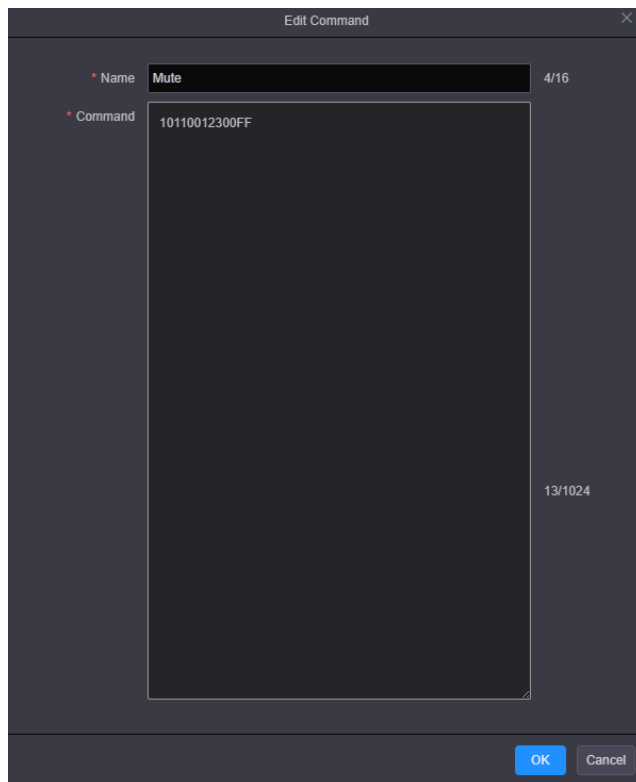

Step 2 Edit the command name and code.

Step 3 Click **OK** to complete the editing.

6.5.8.6 Delete Commands

If the command for the controlled device is changed or removed, you can delete the added command from the system.

Step 1 Check the box next to the desired command.

Check the box in the title bar to select all the commands.

Step 2 Click  at the top right corner of the command list to delete the selected commands.

6.5.9 Firmware Update

The H series supports firmware update through the Web page. Make sure you have downloaded the update package from NovaStar's official website before the update. The system supports the update for the control card, AUX and MVR cards, input cards and output cards. You can select to update a single component or the whole unit.

Figure 6-46 Firmware update

Component	Version	Progress
Control Card		0%
FPGA	2023.10.19 MAIN CTRL V1.9.1.0	0%
MCU	2023.10.19 MAIN CTRL V1.9.1.0	0%
AUX Card		0%
MCU	2023.10.19 H-AUX-SU V1.9.1.0	0%
FPGA	2023.10.19 H-AUX-SU V1.9.1.0	0%
MVR Card		0%
MCU	2023.10.19 H_MVR V1.9.1.0	0%
FPGA	2023.10.19 H_MVR V1.9.1.0	0%
Input Card		0%
Input Card 2		0%
MCU	2023.07.04 H-46SLDWH V1.8.0.0	0%
FPGA	2023.07.04 H-46SLDWH V1.8.0.0	0%
Input Card 3		0%
MCU	2023.10.19 H-AUDIO-I V1.9.1.0	0%
FPGA	2023.10.19 H-AUDIO-I V1.9.1.0	0%
Input Card 4		0%
MCU	2023.07.21 H_IPC_CARD V1.8.0.0	0%
FPGA	2023.07.21 H_IPC_CARD V1.8.0.0	0%
Input Card 5		0%
MCU	2023.10.19 H-46HDM-AUDIO-I V1.9.1.0	0%
FPGA	2023.10.19 H-46HDM-AUDIO-I V1.9.1.0	0%

The update procedure is as follows.

- Step 1 Firstly, make sure you have downloaded the software package of the component to be updated from NovaStar's official website.
- Step 2 Click **Firmware Update** on the left to enter the update page.
- Step 3 Click **Browse** to select the location of the version to be updated in the pop-up dialog box.
- Step 4 Click **Update All** to update the components of the software in the current software package automatically.

Advanced Update

- Step 1 Firstly, make sure you have downloaded the software package of the component to be updated from NovaStar's official website.
- Step 2 Click **Firmware Update** on the left to enter the update page.
- Step 3 Click **Browse** to choose the location of the version to be updated in the pop-up dialog box.
- Step 4 Select **Advanced** to enter the advanced update page.

The system will select the corresponding components according to the software in the current software package automatically.

- Step 5 You can deselect the unwanted components.
- Step 6 Click **Update** to update the selected components.

Click **Update All** to update the components of the software in the current software package automatically.
Click **Check Version** to view the component versions.

6.5.10 Reset Settings

You can reset the device configuration data to factory defaults.

Figure 6-47 Reset

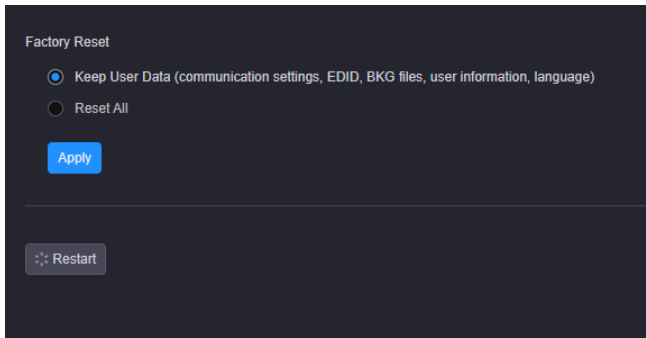

Factory Reset

Select the desired reset mode and click **Apply**.

- **Keep User Data:** When you reset the device, the following information will still be kept in the system, including the communication settings, EDID, BKG files, user information and language settings as well as other user data.
- **Reset All:** Reset all the parameters to factory defaults.

When you select **Reset All**, the language settings screen will be displayed on the device LCD screen and Web page after the device is started. Select the desired language and click **OK** to complete the language settings.

Figure 6-48 Web page

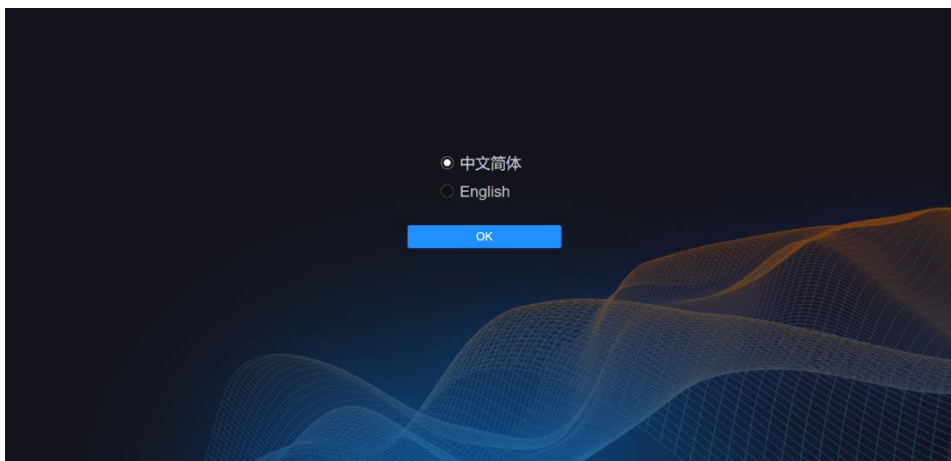

Restart

Click **Restart** and the device will restart automatically.

6.5.11 Other Settings

On this page, you can set the performance, Genlock and preset transition.

Figure 6-49 Other settings

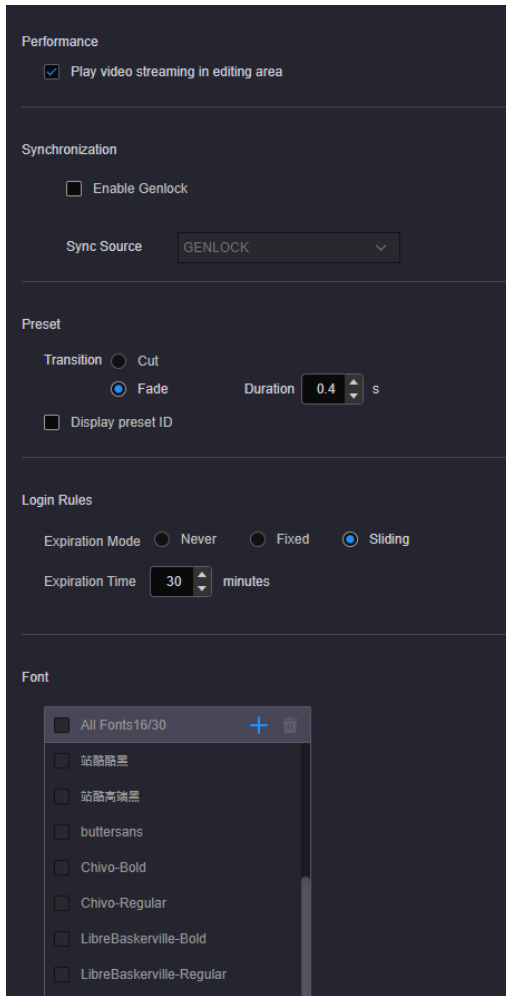

Performance

Set whether to play the video streaming of the layer in the editing area. Turn off this function for quicker layer configuration.

Genlock

Set whether to use the external Genlock sync source.

- Select **Enable Genlock** to turn on the Genlock function.
- Deselect **Enable Genlock** to turn off the Genlock function.

Preset

Set the preset transition effect. Cut and fade effects are supported. When **Fade** is selected, the transition duration can be set.

Check the box next to **Display preset ID** and the system will automatically add an ID for each added preset.

The preset ID contains four digits and is displayed in front of the preset name. Once enabled, it will be added automatically by the system and cannot be changed.

Login Rules

Set the expiration mode and time after the user logs in to the Web page.

- Expiration Mode: Set the expiration mode when the login has expired. The supported options include **Never**, **Fixed** and **Sliding**.
 - Never: The login is long-term valid with no need to log in to the system again.

- Fixed: Set the expiration time. If the login time exceeds the set time, the login will automatically expire and the user needs to log in to the system again for operations.
- Sliding: Set the expiration time. If no operation is made during the set time, the login will automatically expire and the user needs to log in to the system again for operations.
- Expiration Time: Set the default login time. The default value is 30 minutes.

Text Font

The H series supports uploading local text fonts to the system, and the uploaded fonts can be used for OSD font settings.

- Add: Click **+** to select the font files to be added in the popup dialog. Click **Open** to upload the selected fonts to the system.
- Delete: In the font list, check the box in front of the font name, and then click  to delete the selected font, but the built-in font cannot be deleted.

6.5.12 Help

View the documents provided to help you, such as tutorials, manuals and related installation packages.

Figure 6-50 Help

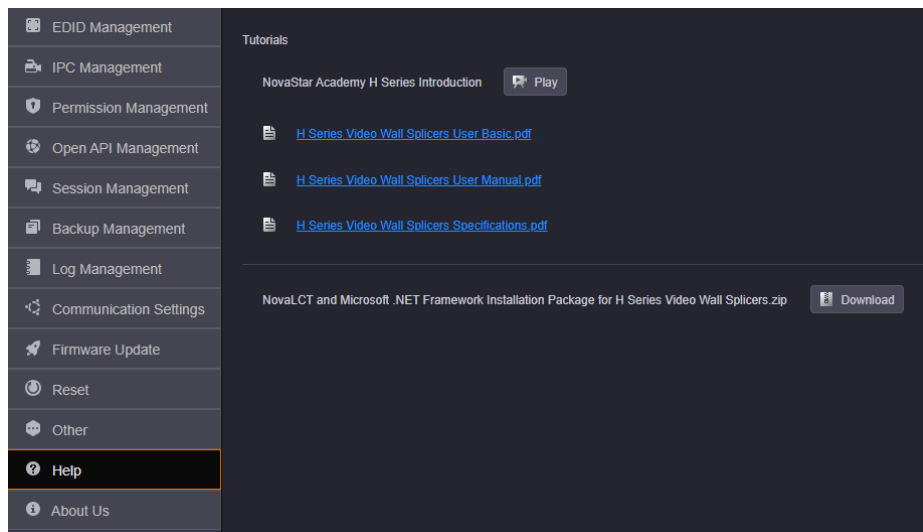

6.5.13 About Us

On this page, you can view the information such as the official website, email address and device version.

Click **Download Log** to download the device operation log. When the device fails, you can download the log and send it to your device manufacturer for analyzing problems and offering suggestions to fix the problems.

Copyright © 2024 Xi'an NovaStar Tech Co., Ltd. All Rights Reserved.

No part of this document may be copied, reproduced, extracted or transmitted in any form or by any means without the prior written consent of Xi'an NovaStar Tech Co., Ltd.

Trademark

NOVA STAR is a trademark of Xi'an NovaStar Tech Co., Ltd.

Statement

Thank you for choosing NovaStar's product. This document is intended to help you understand and use the product. For accuracy and reliability, NovaStar may make improvements and/or changes to this document at any time and without notice. If you experience any problems in use or have any suggestions, please contact us via the contact information given in this document. We will do our best to solve any issues, as well as evaluate and implement any suggestions.

[Official website](http://www.novastar.tech)
www.novastar.tech

[Technical support](mailto:support@novastar.tech)
support@novastar.tech