

H Series

Video Wall Splicers

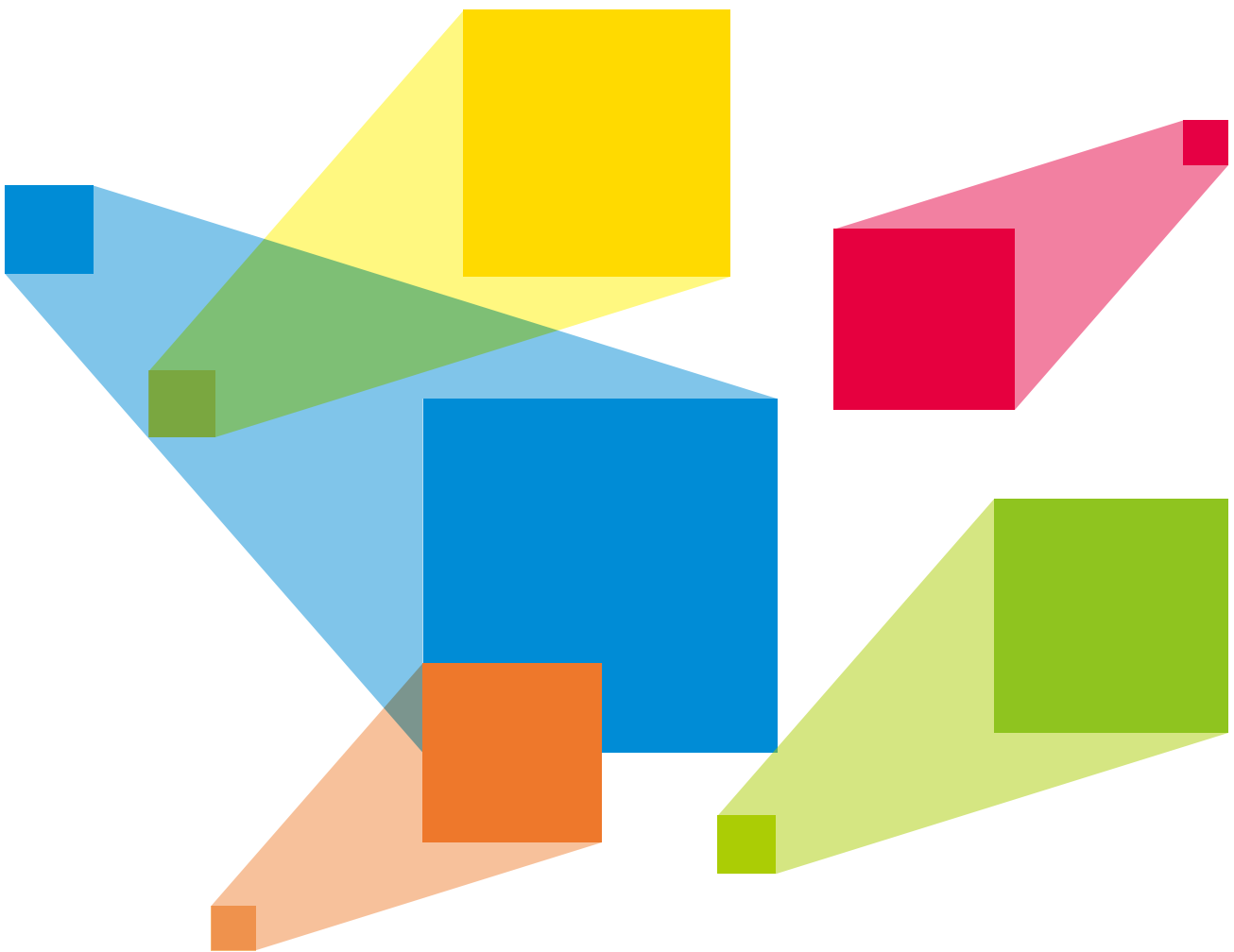

Quick Start Guide

Device Connections

1 Input

Connect the video sources to corresponding connectors on the input cards.

Note

The card marked with an "IN" is an input card.

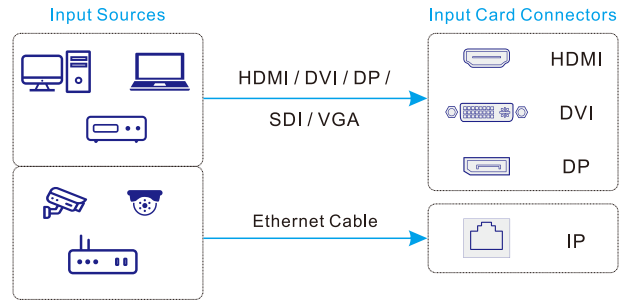

2 Output

H_16xRJ45+2xFiber Sending Card

- Connect the Ethernet ports of this card to the LED screen directly. The LED screen parameters and screen connections can be set in NovaLCT.
- Connect the OPT ports of this card to a fiber converter first, and then connect the fiber converter to the LED screen.

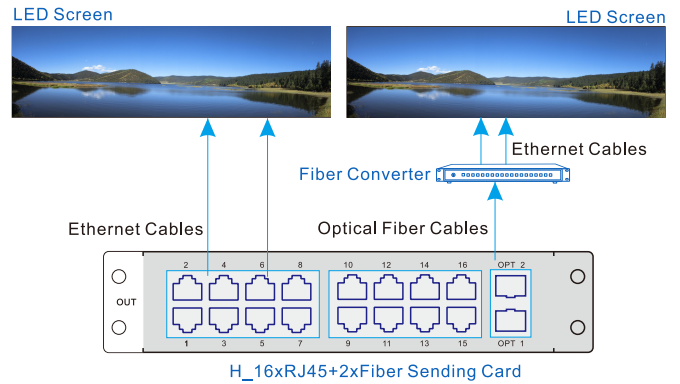

3 Power Supply

Plug the supplied power cord and power on the device.

Power specification: 100-240V~, 50/60Hz

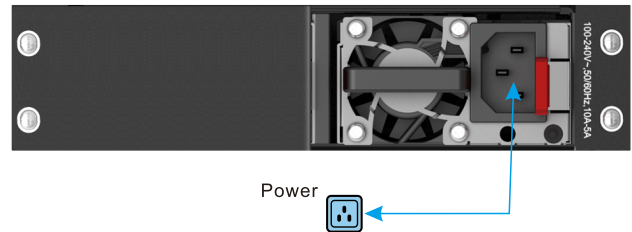

4 Control

You can control the H series video wall splicers through either of the following two methods.

• Method I: Direct control

Connect the Ethernet port on the control card to the control PC.

• Method II: Using a router or switch (wired or wireless)

Connect the Ethernet ports of both the device control card and control PC to the LAN ports of the router or switch.

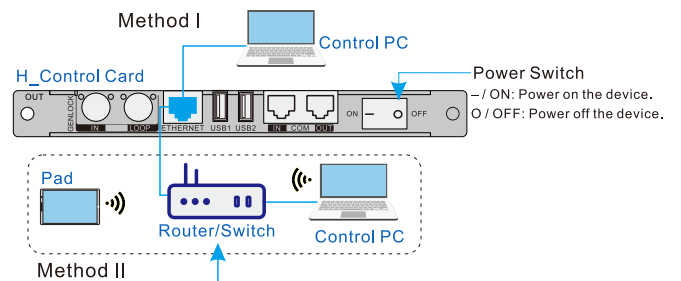

5 Monitoring

- **Ethernet monitoring:** Connect one of the Ethernet ports on the preview card and the Ethernet port of the control card to the same switch for the input source and screen monitoring on the Web page.
- **HDMI monitoring:** Connect the HDMI connector of the device preview card to a monitor directly.

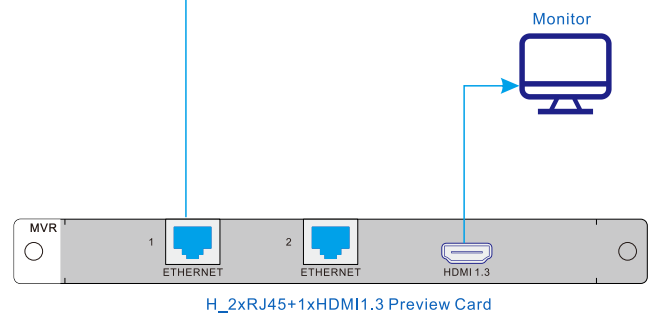

Device Login

The H series video wall splicers support Web page control using a PC or tablet.

Supported web browser: [Google Chrome \(64-bit\)](#)

Connect the power cord and set the rocker switch on the [H_Control Card](#) to **ON**. The device home screen is lit and displays the home screen.

Notes

- The IP addresses of the control PC and device must be on the same network segment.
- You can obtain the [device IP address](#) from the home screen. The default IP address of the device is 192. 168. 0. 10, and the IP address of the control PC must be 192. 168. 0. X. X cannot be the same as the last number in the device default IP address.
- The default user name and password are both **admin**.

- Enter the [device IP address](#) into your browser's address bar and press **Enter**. The Web page appears.
- Enter the user name and password, and then click **Login**.

Here is an H9 home screen.

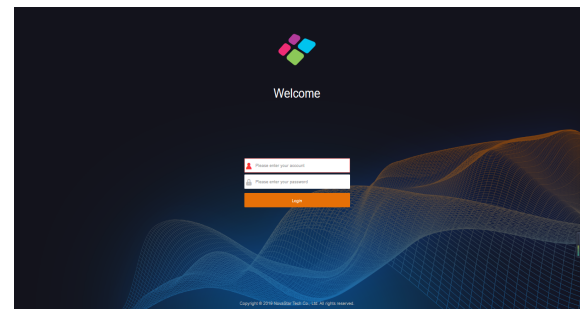
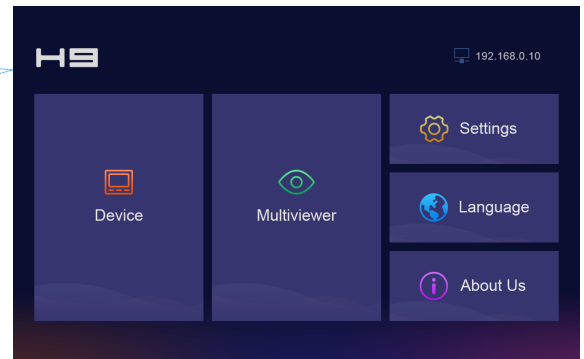

Screen Configuration

Associate the device outputs with the LED screen based on the current structure and data flow of the screen loaded by the device.

- Only the outputs that have the same resolution and are from the output connectors of the same type can be configured on a screen.
- For the [H_16xRJ45+2xFiber Sending Card](#), the [virtual 4K 4K](#) connectors are shown on the configuration page.
- Recommended NovaLCT version: [NovaLCT V5.3.1](#) or later.

- Select **Configuration** to enter the screen configuration page.
- Click **New Screen** at the top to pop up the **New Screen** window to add a new screen.
- Set the screen row and column quantities according to on-site setup, and then click **OK**.
- Click and drag an output connector on the left to the screen editing area to complete the screen configuration.
- Log in to NovaLCT, and go to **Screen Configuration > Screen Connection**. Set the Ethernet ports, screen and cabinet connections.

- [Sending Card Numbers](#) correspond to the sequence numbers of the installed [H_16xRJ45+2xFiber Sending Cards](#) on the device rear panel (from left to right / from top to bottom).
- [Ethernet Port No.](#) corresponds to the sequence number of the Ethernet port on the [H_16xRJ45+2xFiber Sending Card](#).

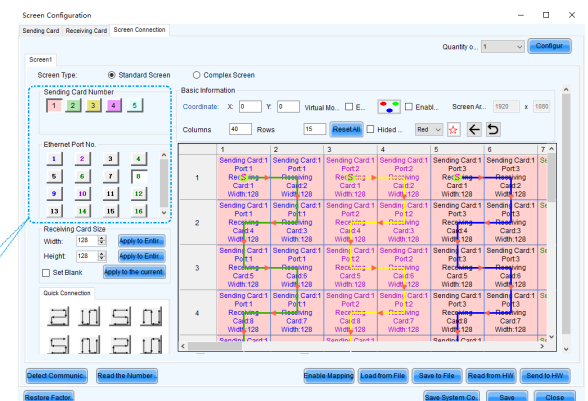
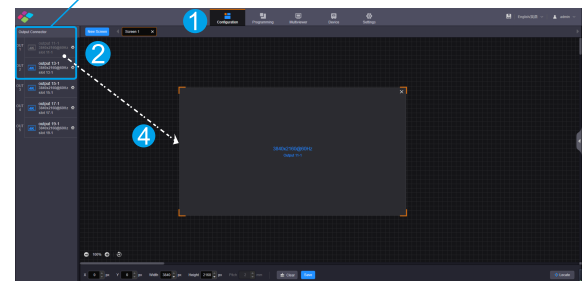

Note

For the screen configuration details in NovaLCT, please see the NovaLCT User Manual.

Programming

Adding Layers

Add, clear, sort, move and resize the layers after a screen is added.

- 1 Select **Programming** to enter the layer editing page.
- 2 Select the desired screen on the top.
- 3 Add a layer.
Click and drag an input source on the left to the editing area to add a layer.
 - Click and drag the layer edge to quickly resize the layer.
 - Enter the **Width** and **Height** values to precisely resize the layer.
 - Click and drag the layer area to quickly move the layer.
 - Enter the **X** and **Y** values at the bottom to precisely move the layer.
- 4 Add a BKG or OSD.
 1. Click the **OSD** or **BKG** button at the top to expand the OSD or BKG settings pane.
 2. Enable the OSD or BKG function by selecting **Enable**.
 3. Click a BKG image and it will be added to the editing area automatically.
OSD text or image will be added to the screen automatically.

- Turned on: The screen displays the layer editing process in real time.



- Turned off: Click **Cut** after the layer settings are completed, and the screen displays the layer.

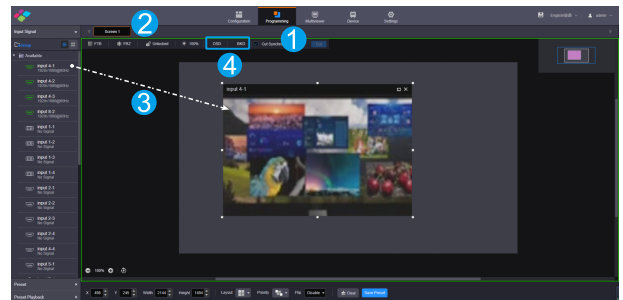
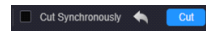

Notes

- Drag an input source to an existing layer to quickly switch the layer input source.
- Click **Layout** at the bottom to quickly add and arrange the layers.
- Click **Clear** at the bottom to clear all the layers.
- Make sure you have imported BKG or OSD files before you add a BKG or OSD.

Preset

Save the screen and layer information that have been edited on the **Programming** page as a preset, and then load the preset if needed.

The preset is saved for the screen that you select, so the preset changes when you select a different screen.

Saving Presets

- 1 After the layer settings are completed on the **Programming** page, click **Save Preset** at the bottom to save the settings as a preset.
- 2 Name the preset in the **Save Preset** window that appears, and click **OK** to save the change.

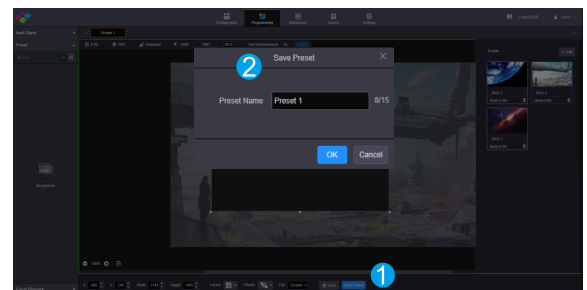

Loading Presets

- 1 Click **Preset** on the left of the **Programming** page to show the preset list.
- 2 Select a saved preset and then click  that appears next to the preset name to load this preset.

Note

- Click  above the preset list to switch to thumbnail view that allows you to view the layer layout of the preset.

Multiviewer

Configuring Multiviewer

- 1 Select **Multiviewer** to enter the Multiviewer settings page.
- 2 Select the **Screen** or **Input** tab on the left, and then click and drag a screen or input source to the editing area to add an MVR window.

After the settings, go to **Multiviewer** on the home screen or Web page to view the monitoring information.

- **Screen** allows you to monitor the output images on each screen. **Input** allows you to monitor the input source images.
- The added screens or input sources are shown in gray in the left area.
- Select an MVR layout at the bottom to quickly arrange the MVR windows.



Device

View the device connection status and monitor the device running status.

Diagnose the device by using the self-test function to quickly locate the device problems.

- Green connector: The connector is connected.
White connector: The connector is not connected, or the connected device fails.
Gray connector: The connector is unavailable.
- Click the drop-down arrow next to the fan icon to view the statuses of all fans.
- Click **Self-Test** to quickly detect and locate the device problems, and then send the test result to NovaStar technical support engineers for fixing the problems.

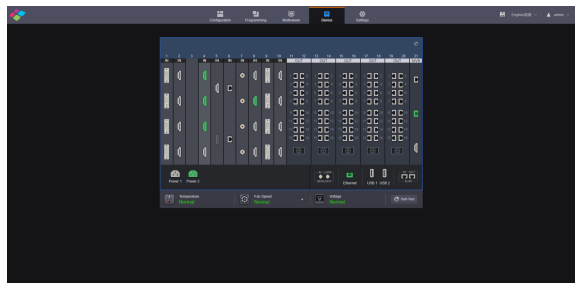

Settings

Manage the input and output resolutions, IPC, users, backup, communication, reset and other settings.

Setting Input and Output Resolutions

- 1 Click **EDID Management** on the left to enter the input and output EDID settings page.
- 2 Click the **Input** or **Output** tab, and then select one or multiple input or output connectors.
- 3 Set the EDID parameters on the right.
- 4 Click **Apply** to make the settings take effect.

Notes

- Setting the EDID for multiple input or output connectors simultaneously is only applicable to the connectors of the same type.
- After the settings, you can export the configuration file for future use if necessary.

