

# GEO S1210-ST

# NEXO

## geo S1210-ST

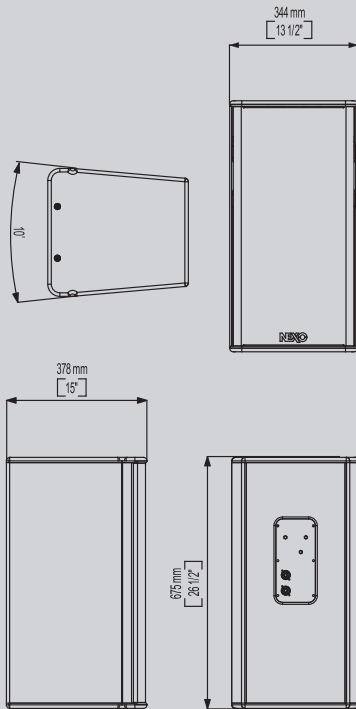

### GEO S1210-ST Advantages

- High SPL for long-throw applications
- Enhanced speech intelligibility
- Coherent Wave Propagation from NEXO's Advanced GEO Hyperbolic Wavesource
- Advanced Constant Velocity Profile Output from 5.1° Wavefront Curvature
- NS-1 Configurable, EtherSound™ (Network)

### GEO S1210-ST Recommended For

- Stadia/Arena/Auditorium Installations (Any Scale)
- High Traffic Walkways and Public Waiting Areas

NEXO's compact, 2-way GEO S1210-ST is a high-output, long throw version of the standard GEO S1210 cabinet, designed for stadium installations. While a narrow-Q (10°) device in single-source mode, S1210-ST's unique Hyperboloid Reflective Wavesource (HRW) also allows coupled S1210-STs to radiate as coherent, wavefronts, in either horizontally or vertically arrayed systems. GEO S1210-ST's coupled MF/HF pattern control is array-

dependent, as designed by NS-1 array software, and configured according to venue-specific geometry. Non-coupled MF/HF coverage configures at 80° or 120°. The S1210-ST module displays exceptional MF-LF output (105dB SPL nominal sensitivity -1W @1m) from a single 12" loudspeaker and NEXO's proprietary Directivity Phase Device (DPD). NEXO's digital N242 TDcontroller maximizes S1210's MF/HF coherency.

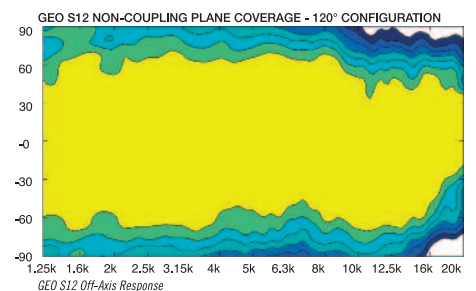
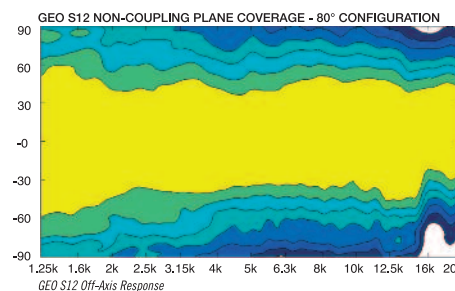

**NEXO**  
www.nexo.fr

# GEO S1210-ST

# NEXO

## GEO S1210-ST



NEXO is one of the world's leading sound reinforcement loudspeaker manufacturers. Founded in 1979, the company is dedicated to crafting practical solutions with solid engineering. Each new design begins with a proprietary sophisticated computer simulation process that allows every parameter to be extensively modeled and simulated, leading to breakthrough cost and performance gains. NEXO's comprehensive product line includes loudspeakers, analogue and digital control electronics and amplification; all designed to deliver consistent sound quality and long term reliability for a broad range of applications.

NEXO S.A.  
Parc d'Activité  
du Pré de la Dame Jeanne  
B.P. 5  
60128 PLAILLY  
Tel: +33 (0) 3 44 99 00 70  
Fax: +33 (0) 3 44 99 00 30  
e-mail: info@nexo.fr

NEXO LatAm  
Tel: +1 305 677 9322  
Fax: +1 360 234 7870  
e-mail: info@nexo.fr

NEXO Asia  
GPO Box 806  
Hong Kong  
SAR China  
Tel: +852 9096 3472  
Fax: +852 2104 3214  
e-mail: info@nexo.fr

**NEXO**  
www.nexo.fr

### GEO S1210-ST PRODUCT FEATURES

Components	HF: 1 x 3" voice coil, 1.4" throat 16Ω ND driver on a 5° hyperboloid reflective wavesource. LF: 1 x 12" (30cm) high excursion neodymium 16Ω driver.
Height x Width x Depth	344 x 675 x 378 mm (13 1/2" x 26 1/2" x 14 7/8") excluding accessories Rigging axis to axis height: 345mm (13 1/2")
Shape	10° Trapezoid
Weight net	28.05kg (61.8 lbs) excluding accessories.
Connectors	2x NL4MP SPEAKON 4-pole (In & Through)
Construction	Baltic Birch ply with structured black coating.
Front finish	Molded Dark Grey Metal Grill.
Flying points	Two plates connecting with external accessories. Intercabinet angle adjustments = 0.2°, 0.315°, 0.5°, 0.8°, 1.25°, 2.0°, 3.15°, 5°, 6.3°, 8.0°, 10.0° (logarithmic steps)

### SYSTEM SPECIFICATIONS GEO S1210-ST with NX242 TDcontroller & NX-tension Card

Frequency response [a]	53Hz – 19kHz ±3dB
Usable range @-6dB [a]	50Hz – 20kHz
Sensitivity 1W @ 1m [b]	105dB SPL nominal
Peak SPL @ 1m [b]	Configuration Dependent [d]
Dispersion [c]	Coupling Plane: Configuration dependent [d] Non-Coupling Plane: Configurable 80° / 120°
Crossover frequency	LF- HF: 1.1kHz Passive or Active (internally configurable)
Nominal impedance	HF: 16Ω; LF: 16Ω
Recommended amplifiers	
3x GEO S1210-ST in parallel	HF: 875 to 1550W into 4Ω LF: 1750 to 3100W into 4Ω
4x GEO S1210-ST in parallel	HF: 1000 to 1800W into 4Ω LF: 2000 to 3600W into 4Ω
6x GEO S1210-ST in parallel	HF: 1650 to 3000W into 2Ω LF: 3300 to 6000W into 2Ω

### SYSTEM OPERATION

Electronic Controller	The NEXO TDcontrollers presets are precisely matched to the GEO S12 Series cabinets and include sophisticated protection. Using GEO S12 Series cabinets without a properly connected NEXO TDcontrollers will result in poor sound quality and can damage components.
Array Design	Arrays of less than 4x GEO S1210 will provide poor dispersion control and neither recommended nor supported.
Sub-Bass	RS18 extend system low frequency response down to 35 Hz
Speaker Cables	Active: 1-/1+;LF; 2-/2+; HF / Passive: 1-/1+; Not Connected; 2-/2+;LF + HF.
Accessories	Please refer to the GEO S12 User Manual before operation.

As part of a policy of continual improvement, NEXO reserves the right to change specifications without notice. [a] Response curves and data: anechoic far field above 200 Hz, half-space anechoic below 200 Hz. [b] Sensitivity & peak SPL: will depend on spectral distribution. Measured with band limited pink noise. Refers to the specified +/- 3 dB range. Data are for speaker + processor + recommended amplifier combinations. [c] Directivity curves and data: 1/3 octave smoothed frequency response, normalized to on-axis response. Data obtained by computer processing of off-axis response curves. [d] Please refer to the GEO S12 user Manual. Usable range data: frequency response capability with TD crossover slopes removed.

#### LIMITED WARRANTY

NEXO loudspeakers and electronics are covered against defects in workmanship or materials for a period of two (2) years from the original date of purchase. At the option of NEXO the defective item will be repaired/replaced with no charge for materials/labour. The item is to be adequately packaged and dispatched, pre-paid, to a NEXO authorised distributor/service centre. Unauthorised repair shall void the warranty. The NEXO warranty does not cover cosmetics or finish and does not apply to any items which in NEXO's opinion have failed due to used abuse, accidents, modifications or any type of misuse. All images and text herein are the property of NEXO SA, and deemed accurate, although specifications are subject to change without notice.



# GEO S1230-ST

# NEXO

## geo S12-ST

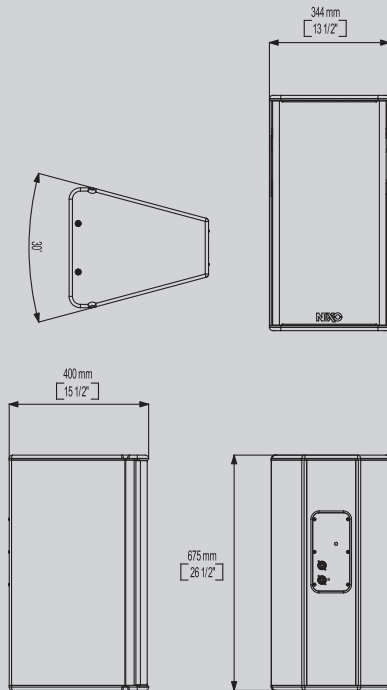

### GEO S1230-ST Advantages

- High SPL for long-throw applications
- Enhanced speech intelligibility
- Coherent Wave Propagation from NEXO's Advanced GEO Hyperbolic Wavesource
- Advanced Constant Velocity Profile Output from 28.5° Wavefront Curvature
- NS-1 Configurable, EtherSound™ (Network)

### GEO S1230-ST Recommended For

- Stadia/Arena/Auditorium Installations (Any Scale)
- High Traffic Walkways and Public Waiting Areas

NEXO's compact, 2-way GEO S1230-ST is a high-output, long throw version of the standard GEO S1230 cabinet, designed for stadium installations. While a narrow-Q (30°) device in single-source mode, S1230-ST's unique Hyperboloid Reflective Wavesource (HRW) also allows coupled S1230-STs to radiate as coherent, wavefronts, in either horizontally or vertically arrayed systems. GEO S1230-ST's coupled MF/HF pattern control is array-

dependent, as designed by NS-1 array software, and configured according to venue-specific geometry. Non-coupled MF/HF coverage configures at 80° or 120°. The S1230-ST module displays exceptional MF-LF output (105dB SPL nominal sensitivity -1W @1m) from a single 12" loudspeaker and NEXO's proprietary Directivity Phase Device (DPD). NEXO's digital N242 TDcontroller maximizes S1230's MF/HF coherency.

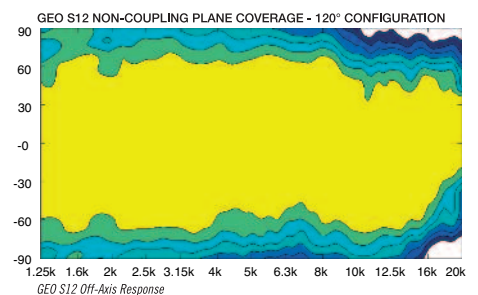
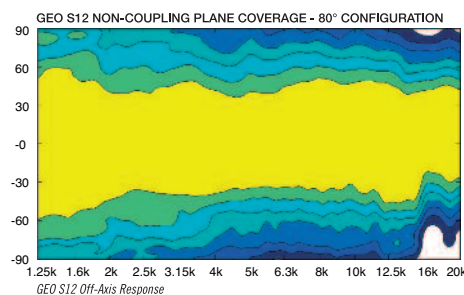

**NEXO**  
www.nexo.fr

# GEO S1230-ST

# NEXO

## GEO S12-ST



NEXO is one of the world's leading sound reinforcement loudspeaker manufacturers. Founded in 1979, the company is dedicated to crafting practical solutions with solid engineering. Each new design begins with a proprietary sophisticated computer simulation process that allows every parameter to be extensively modeled and simulated, leading to breakthrough cost and performance gains. NEXO's comprehensive product line includes loudspeakers, analogue and digital control electronics and amplification; all designed to deliver consistent sound quality and long term reliability for a broad range of applications.

NEXO S.A.  
Parc d'Activité  
du Pré de la Dame Jeanne  
B.P. 5  
60128 PLAILLY  
Tel: +33 (0) 3 44 99 00 70  
Fax: +33 (0) 3 44 99 00 30  
e-mail: info@nexo.fr

NEXO LatAm  
Tel: +1 305 677 9322  
Fax: +1 360 234 7870  
e-mail: info@nexo.fr

NEXO Asia  
GPO Box 806  
Hong Kong  
SAR China  
Tel: +852 9096 3472  
Fax: +852 2104 3214  
e-mail: info@nexo.fr

**NEXO**  
www.nexo.fr

### GEO S1230-ST PRODUCT FEATURES

Components	HF: 1 x 3" voice coil, 1.4" throat 16Ω ND driver on a 5° hyperboloid reflective wavesource. LF: 1 x 12" (30cm) high excursion neodymium 16Ω driver.
Height x Width x Depth	344 x 675 x 400 mm (13 1/2" x 26 1/2" x 15 1/2") excluding accessories Rigging axis to axis height: 345mm (13 1/2")
Shape	30° Trapezoid
Weight net	26.8kg (59.1lbs) excluding accessories
Connectors	2x NL4MP SPEAKON 4-pole (In & Through)
Construction	Baltic Birch ply with structured black coating
Front finish	Molded Dark Grey Metal Grill
Flying points	Two plates connecting with external accessories. Intercabinet angle adjustments = (16°) - 22.5° - 30°.

### SYSTEM SPECIFICATIONS GEO S1230-ST with NX242 TDcontroller & NX-tension Card

Frequency response [a]	53Hz – 19kHz ±3dB
Usable range @-6dB [a]	50Hz – 20kHz
Sensitivity 1W @ 1m [b]	105dB SPL nominal
Peak SPL @ 1m [b]	133 to 135dB Peak (for 500 to 900 W RMS Amplifier)
Dispersion [c]	Coupling Plane: 28.5° Non-Coupling Plane: Configurable 80° / 120°
Crossover frequency	LF- HF: 1.1kHz Passive or Active (internally configurable).
Nominal impedance	HF: 16Ω; LF: 16Ω
Recommended amplifiers	
3x GEO S1230-ST in parallel	HF: 875 to 1550W into 4Ω LF: 1750 to 3100W into 4Ω
4x GEO S1230-ST in parallel	HF: 1000 to 1800W into 4Ω LF: 2000 to 3600W into 4Ω-ST
6x GEO S1230 in parallel	HF: 1650 to 3000W into 2Ω LF: 3300 to 6000W into 2Ω

### SYSTEM OPERATION

Electronic Controller	The NEXO TDcontrollers presets are precisely matched to the GEO S12 Series cabinets and include sophisticated protection. Using GEO S12 Series cabinets without a properly connected NEXO TDcontrollers will result in poor sound quality and can damage components.
Sub-Bass	RS18 extend system low frequency response down to 35 Hz
Speaker Cables	Active: 1-/1+;LF; 2-/2+; HF / Passive: 1-/1+; Not Connected; 2-/2+;LF + HF.
Accessories	Please refer to the GEO S12 User Manual before operation.

As part of a policy of continual improvement, NEXO reserves the right to change specifications without notice. [a] Response curves and data: anechoic far field above 200 Hz, half-space anechoic below 200 Hz. [b] Sensitivity & peak SPL: will depend on spectral distribution. Measured with band limited pink noise. Refers to the specified +/- 3 dB range. Data are for speaker + processor + recommended amplifier combinations. [c] Directivity curves and data: 1/3 octave smoothed frequency response, normalized to on-axis response. Data obtained by computer processing of off-axis response curves. [d] Please refer to the GEO S12 user Manual. Usable range data: frequency response capability with TD crossover slopes removed.

#### LIMITED WARRANTY

NEXO loudspeakers and electronics are covered against defects in workmanship or materials for a period of two (2) years from the original date of purchase. At the option of NEXO the defective item will be repaired/replaced with no charge for materials/labour. The item is to be adequately packaged and dispatched, pre-paid, to a NEXO authorised distributor/service centre. Unauthorised repair shall void the warranty. The NEXO warranty does not cover cosmetics or finish and does not apply to any items which in NEXO's opinion have failed due to used abuse, accidents, modifications or any type of misuse. All images and text herein are the property of NEXO SA, and deemed accurate, although specifications are subject to change without notice.

# GEO S1230

# NEXO

## Geo S12

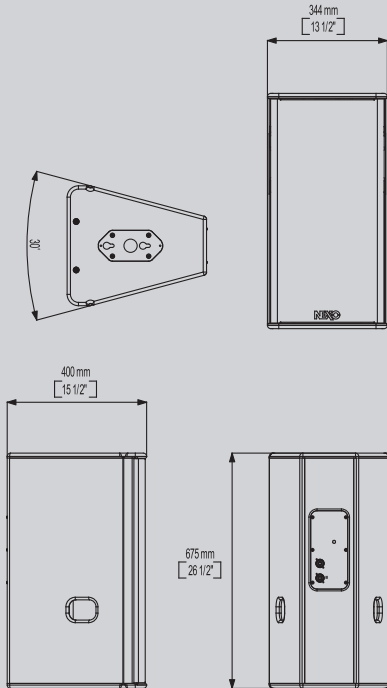

### GEO S1230 Advantages

- Coherent Wave Propagation from NEXO's Advanced GEO Hyperbolic Wavesource
- Advanced Constant Velocity Profile Output from 28.5° Wavefront Curvature
- Integral Rigging System with Angles from 22.5° to 30°
- GeoSoft2 Configurable, EtherSound™ (Network)
- Bottom-Line Engineering for Theatre to Arena-Sized Fixed & Mobile Applications

### GEO S1230 is recommended for

- Stadia/Arena/Auditorium Installations (Any Scale)
- High Traffic Walkways and Public Waiting Areas
- Foreground Playback for Nightclubs and Discos
- Corporate AV and Presentation Systems
- Portable Entertainment and DJ Systems
- Small to Mid-Size Tour Systems
- Houses of Worship

NEXO's compact, 2-way GEO S1230 is a scalable high-output, loudspeaker module. While a narrow-Q (30°) device in single-source mode, S1230's unique Hyperboloid Reflective Wavesource (HRW) also allows coupled S1230s to radiate as coherent, wavefronts, in either horizontally or vertically arrayed systems. GEO S1230's coupled MF/HF pattern control is array-dependent, as designed by GEOSoft2 array software, and configured according to venue-specific geometry. Non-coupled MF/HF coverage configures at 80° or 120°.

The S1230 module displays exceptional MF-LF output (103dB SPL nominal sensitivity -1W @1m) from a single 12" loudspeaker and NEXO's proprietary Directivity Phase Device (DPD). Precise, inter-cabinet angle adjustments, are optimized by integral flying system hardware while NEXO's digital N242 TDcontroller maximizes S1230's MF/HF coherency.

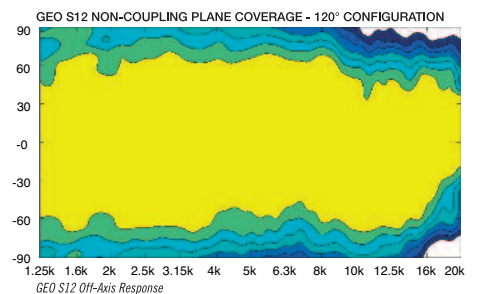
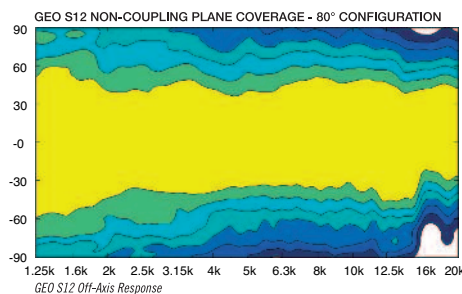

**NEXO**  
www.nexo.fr



# GEO S1230

# NEXO

## Geo S12



NEXO is one of the world's leading sound reinforcement loudspeaker manufacturers. Founded in 1979, the company is dedicated to crafting practical solutions with solid engineering. Each new design begins with a proprietary sophisticated computer simulation process that allows every parameter to be extensively modeled and simulated, leading to breakthrough cost and performance gains. NEXO's comprehensive product line includes loudspeakers, analogue and digital control electronics and amplification; all designed to deliver consistent sound quality and long term reliability for a broad range of applications.

NEXO S.A.  
Parc d'Activité  
du Pré de la Dame Jeanne  
B.P. 5  
60128 PLAILLY  
Tel: +33 (0) 3 44 99 00 70  
Fax: +33 (0) 3 44 99 00 30  
e-mail: info@nexo.fr

NEXO LatAM  
Tel: +1 305 677 9322  
Fax: +1 360 234 7870  
e-mail: info@nexo.fr

NEXO Asia  
GPO Box 806  
Hong Kong  
SAR China  
Tel: +852 9096 3472  
Fax: +852 2104 3214  
e-mail: info@nexo.fr

**NEXO**  
www.nexo.fr

### GEO S1230 PRODUCT FEATURES

Components	HF: 1x 3" voice coil, 1.4" throat 16Ω driver on a 30° hyperboloid reflective wavesource. MF/LF (front-firing): 1x 12" (30cm) high excursion neodymium 16Ω driver.
Height x Width x Depth	344 x 674 x 400 mm (13 1/2" x 26 1/2" x 15 1/2") excluding accessories. Rigging axis to axis height: 345mm (13 1/2")
Shape	30° Trapezoid
Weight net	26.8kg (59.1lbs) excluding accessories
Connectors	2x NL4MP SPEAKON 4-pole (In & Through)
Construction	Baltic Birch ply with structured black coating
Front finish	Molded Dark Grey Metal Grill
Flying points	Two plates connecting with external accessories. Intercabinet angle adjustments = (16°) - 22.5° - 30°.

### SYSTEM SPECIFICATIONS GEO S1230

Frequency response [a]	53Hz – 19kHz ±3dB
Usable range @-6dB [a]	50Hz – 20kHz
Sensitivity	103dB SPL nominal
Peak SPL @ 1m [b]	131 to 133dB Peak (for 500 to 900 W RMS Amplifier)
Dispersion [c]	Coupling Plane: 28.5° Non-Coupling Plane: Configurable 80° / 120°
Crossover frequency	LF- HF: 1.1kHz Passive or Active (internally configurable).
Nominal impedance	16Ω
Recommended amplifiers	
3x GEO S1210 in parallel	HF: 875 to 1550W into 4Ω LF: 1750 to 3100W into 4Ω
4x GEO S1210 in parallel	HF: 1000 to 1800W into 4Ω LF: 2000 to 3600W into 4Ω
6x GEO S1210 in parallel	HF: 1650 to 3000W into 2Ω LF: 3300 to 6000W into 2Ω

### SYSTEM OPERATION

Electronic Controller	NEXO TDcontroller presets are precisely matched to GEO S12 Series cabinets and include sophisticated protection. Using GEO S12 Series cabinets with improperly connected TDcontrollers will result in poor sound quality and can damage components.
Array Design	Arrays of less than 4x GEO S1210 will provide poor dispersion control and neither recommended nor supported.
Sub-Bass	RS15 / CD18 / GEO SUB / S2 extend system low frequency response down to 35Hz / 32Hz / 38Hz / 32Hz.
Speaker Cables	Active: 1-/1+:LF; 2-/2+: HF / Passive: 1-/1+: Not Connected; 2-/2+:LF + HF.
Rigging System	Please refer to the GEO S1230 User Manual before operation.

### SHIPPING & ORDERING

Packaging	GEO S1230 are packaged individually
Shipping Weight	1x GEO S1230 = 30kg(66.1lbs), 0.15 cu m (5.3 cu ft)

As part of a policy of continual improvement, NEXO reserves the right to change specifications without notice. [a] Response curves and data: anechoic far field above 200Hz, half-space below 200Hz. [b] Sensitivity & peak SPL: will depend on spectral distribution. Measured with band limited pink noise. Refers to the specified ±3dB range. Data are for speaker + processor + recommended amplifier combinations. [c] Directivity curves and data: 1/3 octave smoothed frequency response, normalized to on-axis response. Data obtained by computer processing of offaxis response curves. [d]Please refer to the GEO S1230 User Manual. Usable range data: frequency response capability with TDcontroller crossover slopes removed.

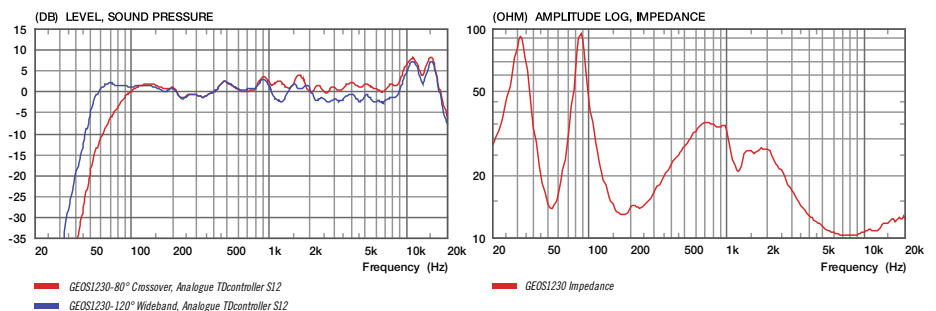

### LIMITED WARRANTY

NEXO loudspeakers and electronics are covered against defects in workmanship or materials for a period of two (2) years from the original date of purchase. At the option of NEXO the defective item will be repaired/replaced with no charge for materials/labour. The item is to be adequately packaged and dispatched, pre-paid, to a NEXO authorised distributor/service centre. Unauthorised repair shall void the warranty. The NEXO warranty does not cover cosmetics or finish and does not apply to any items which in NEXO's opinion have failed due to used abuse, accidents, modifications or any type of misuse. All images and text herein are the property of NEXO SA, and deemed accurate, although specifications are subject to change without notice.

# GEO S1210

# NEXO

## Geo S12

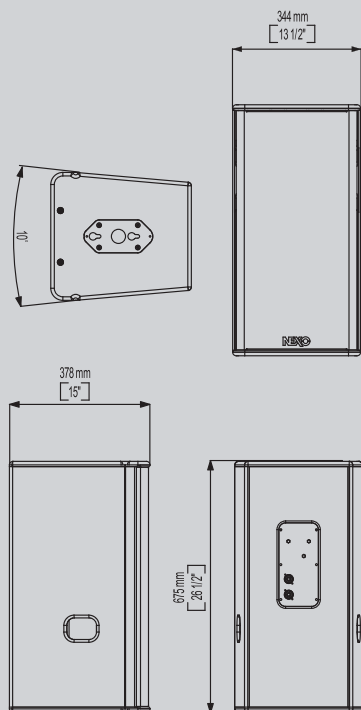

### GEO S1210 Advantages

- Coherent Wave Propagation from NEXO's
- Advanced Constant Velocity Profile Output from 5.1° Wavefront Curvature
- Integral Rigging System with Angles from 0.20° to 10°
- GeoSoft2 Configurable, EtherSound™ (Network)
- Bottom-Line Engineering for Theatre to Arena-Sized Fixed & Mobile Applications

### GEO S1210 is recommended for

- Stadia/Arena/Auditorium Installations (Any Scale)
- High Traffic Walkways and Public Waiting Areas
- Foreground Playback for Nightclubs and Discos
- Corporate AV and Presentation Systems
- Portable Entertainment and DJ Systems
- Small to Mid-Size Tour Systems
- Houses of Worship



NEXO's compact, 2-way GEO S1210 is a scalable high-output, loudspeaker module. While a narrow-Q (10°) device in single-source mode, S1210's unique Hyperboloid Reflective Wavesource (HRW) also allows coupled S1210s to radiate as coherent, wavefronts, in either horizontally or vertically arrayed systems. GEO S1210's coupled MF/HF pattern control is array-dependent, as designed by GEOSoft2 array software, and configured according to venue-specific geometry. Non-coupled MF/HF coverage configures at 80° or 120°.

The S1210 module displays exceptional MF-LF output (103dB SPL nominal sensitivity -1W @1m) from a single 12" loudspeaker and NEXO's proprietary Directivity Phase Device (DPD). Precise, inter-cabinet angle adjustments, are optimized by integral flying system hardware while NEXO's digital N242 TDcontroller maximizes S1210's MF/HF coherency.

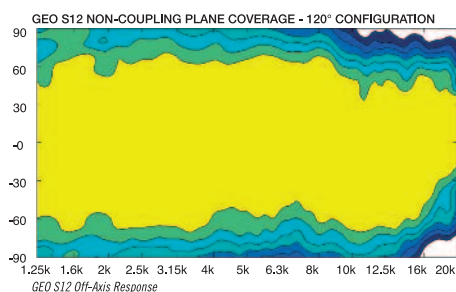
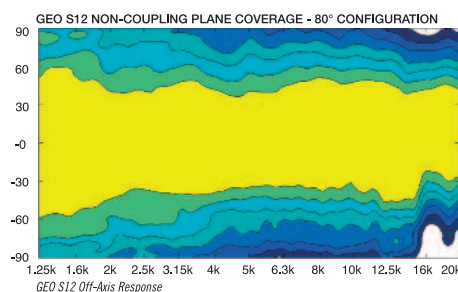

**NEXO**  
www.nexo.fr

## GEO S12



NEXO is one of the world's leading sound reinforcement loudspeaker manufacturers. Founded in 1979, the company is dedicated to crafting practical solutions with solid engineering. Each new design begins with a proprietary sophisticated computer simulation process that allows every parameter to be extensively modeled and simulated, leading to breakthrough cost and performance gains. NEXO's comprehensive product line includes loudspeakers, analogue and digital control electronics and amplification; all designed to deliver consistent sound quality and long term reliability for a broad range of applications.

NEXO S.A.  
 Parc d'Activité  
 du Pré de la Dame Jeanne  
 B.P. 5  
 60128 PLAILLY  
 Tel: +33 (0) 3 44 99 00 70  
 Fax: +33 (0) 3 44 99 00 30  
 e-mail: info@nexo.fr

NEXO LatAM  
 Tel: +1 305 677 9322  
 Fax: +1 360 234 7870  
 e-mail: info@nexo.fr

NEXO Asia  
 GPO Box 806  
 Hong Kong  
 SAR China  
 Tel: +852 9096 3472  
 Fax: +852 2104 3214  
 e-mail: info@nexo.fr

**NEXO**  
 www.nexo.fr

### GEO S1210 PRODUCT FEATURES

Components	HF: 1x 3" voice coil, 1.4" throat 16Ω driver on a 5° hyperboloid reflective wavesource. MF/LF (front-firing): 1x 12" (30cm) high excursion neodymium 16Ω driver.
Height x Width x Depth	344 x 674 x 378 mm (13 1/2" x 26 1/2" x 14 7/8") excluding accessories. Rigging axis to axis height: 345mm (13 1/2")
Shape	10° Trapezoid
Weight net	28.05kg (61.8 lbs) excluding accessories.
Connectors	2x NL4MP SPEAKON 4-pole (In & Through)
Construction	Baltic Birch ply with structured black coating.
Front finish	Molded Dark Grey Metal Grill.
Flying points	Two plates connecting with external accessories. Inter-cabinet angle adjustments = 0.2°, 0.315°, 0.5°, 0.8°; 1.25°, 2.0°, 3.15°, 5°, 6.3°, 8.0°, 10.0° (logarithmic steps)

### SYSTEM SPECIFICATIONS GEO S1210

Frequency response [a]	53Hz – 19kHz ±3dB	
Usable range @-6dB [a]	50Hz – 20kHz	
Sensitivity	103dB SPL nominal	
Peak SPL @ 1m [b]	Configuration dependent [d]	
Dispersion [c]	Coupling Plane: Configuration dependent [d] Non-Coupling Plane: Configurable 80° / 120°	
Crossover frequency	LF- HF: 1.1kHz Passive or Active (internally configurable)	
Nominal impedance	16Ω	
Recommended amplifiers		
3x GEO S1210 in parallel	HF: 875 to 1550W into 4Ω	LF: 1750 to 3100W into 4Ω
4x GEO S1210 in parallel	HF: 1000 to 1800W into 4Ω	LF: 2000 to 3600W into 4Ω
6x GEO S1210 in parallel	HF: 1650 to 3000W into 2Ω	LF: 3300 to 6000W into 2Ω

### SYSTEM OPERATION

Electronic Controller	NEXO TDcontroller presets are precisely matched to GEO S12 Series cabinets and include sophisticated protection. Using GEO S12 Series cabinets with improperly connected TDcontrollers will result in poor sound quality and can damage components.
Array Design	Arrays of less than 4x GEO S1210 will provide poor dispersion control and neither recommended nor supported.
Sub-Bass	RS15 / CD18 / GEO SUB / S2 extend system low frequency response down to 35Hz / 32Hz / 38Hz / 32Hz.
Speaker Cables	Active: 1-/1+:LF; 2-/2+: HF / Passive: 1-/1+: Not Connected; 2-/2+:LF + HF.
Rigging System	Please refer to the GEO S1210 User Manual before operation.

### SHIPPING & ORDERING

Packaging	GEO S1210 are packaged individually
Shipping Weight	1x GEO S1210 = 30kg(66.1lbs), 0.15 cu m (5.3 cu ft)

As part of a policy of continual improvement, NEXO reserves the right to change specifications without notice. [a] Response curves and data: anechoic far field above 200Hz, half-space anechoic below 200Hz. [b] Sensitivity & peak SPL: will depend on spectral distribution. Measured with band limited pink noise. Refers to the specified ±3dB range. Data are for speaker + processor + recommended amplifier combinations. [c] Directivity curves and data: 1/3 octave smoothed frequency response, normalized to on-axis response. Data obtained by computer processing of offaxis response curves. [d] Please refer to the GEO S1230 User Manual. Usable range data: frequency response capability with TDcontroller crossover slopes removed.

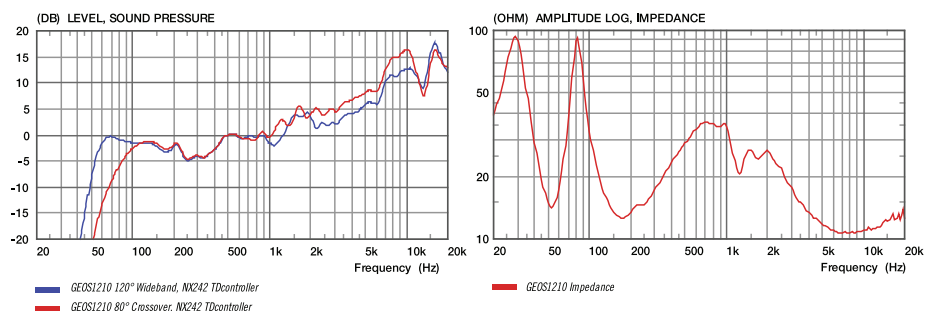

### LIMITED WARRANTY

NEXO loudspeakers and electronics are covered against defects in workmanship or materials for a period of two (2) years from the original date of purchase. At the option of NEXO the defective item will be repaired/replaced with no charge for materials/labour. The item is to be adequately packaged and dispatched, pre-paid, to a NEXO authorised distributor/service centre. Unauthorised repair shall void the warranty. The NEXO warranty does not cover cosmetics or finish and does not apply to any items which in NEXO's opinion have failed due to used abuse, accidents, modifications or any type of misuse. All images and text herein are the property of NEXO SA, and deemed accurate, although specifications are subject to change without notice.