

IRX100

S E R I E S

User's Guide



IRX108-BT



IRX112-BT



CONTENTS

Safety Instructions	3
Declaration of Conformity.....	6
Quick Setup Guide	7
Back Panel.....	9
Overview - IRX100 Series Family.....	10
IRX108/112BT - Block Diagram	11
IRX108BT Specifications	12
IRX112BT Specifications	13
Applications / Features.....	14
Music Ducking / Automatic Feedback Suppression	15
Bluetooth Integration.....	16
Loudspeaker Placement and Suspension.....	19
Cables & Connectors.....	20
Application Examples	21
Troubleshooting	23
Warranty Information	24
Contact Information	25

SAFETY INSTRUCTIONS



The IRX100 Series covered by this manual is not intended for use in high moisture environments. Moisture can damage the speaker cone and surround and cause corrosion of electrical contacts and metal parts. Avoid exposing the speakers to direct moisture.

Keep speakers out of extended or intense direct sunlight. The driver suspension will prematurely dry out and finished surfaces may be degraded by long-term exposure to intense ultra-violet (UV) light. The IRX100 Series can generate considerable energy. When placed on a slippery surface such as polished wood or linoleum, the speaker may move due to its acoustical energy output. Precautions should be taken to assure that the speaker does not fall off a stage or table on which it is placed.

HEARING DAMAGE, PROLONGED EXPOSURE TO EXCESSIVE SPL

The IRX100 Series is capable of generating sound pressure levels (SPL) sufficient to cause permanent hearing damage to performers, production crew, and audience members. Caution should be taken to avoid prolonged exposure to SPL in excess of 85 dB.

CARE & CLEANING

IRX100 Series may be cleaned with a dry cloth. Do not allow moisture into any of the openings in the system. Ensure that the system is unplugged from the AC outlet before cleaning.

THIS APPARATUS CONTAINS POTENTIALLY LETHAL VOLTAGES. TO PREVENT ELECTRIC SHOCK OR HAZARD, DO NOT REMOVE CHASSIS, MIXER MODULE, OR AC INPUT COVERS. NO USER SERVICEABLE PARTS INSIDE. REFER SERVICING TO QUALIFIED SERVICE PERSONNEL.

WEEE Notice

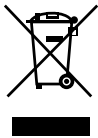

The Directive 2012/19/EU on Waste Electrical and Electronic Equipment (WEEE), which entered into force as European law on 14/02/2014, resulted in a major change in the treatment of electrical equipment at end-of-life. The purpose of this Directive is, as a first priority, the prevention of WEEE, and in addition, to promote the reuse, recycling and other forms of recovery of such wastes so as to reduce disposal. The WEEE logo on the product or on its box indicating collection for electrical and electronic equipment consists of the crossed-out wheeled bin, as shown below. 15.

This product must not be disposed of or dumped with your other household waste. You are liable of dispose of all your electronic or electrical waste equipment by relocating over to the specified collection point for recycling of such hazardous waste. Isolated collection and proper recovery of your electronic and electrical waste equipment at the time of disposal will allow us to help conserving natural resources. Moreover, proper recycling of the electronic and electrical waste equipment will ensure safety of human health and environment. For more information about electronica and electrical waste equipment disposal, recovery, and collection points, please contact your local city center, household waste disposal service, shop from where you purchased the equipment, or manufacturer of the equipment.

RoHS Compliance

This product is in compliance with Directive 2011/65/EU and (EU) 2015/863 of the European Parliament and of the Council of 19. 31/03/2015 on the restriction of the use of certain hazardous substances in electrical and electronic equipment.

REACH

REACH (Regulation No 1907/2006) addresses the production and use of chemical substances and their potential impacts on human health and the environment. Article 33 (1) of REACH Regulation requires suppliers to inform the recipients if an article contains more than 0.1% (per weight per article) of any substance(s) on the Substances of Very High Concern (SVHC) Candidate List ('REACH candidate list').

This product contains the substance "lead" (CAS-No. 7439-92-1) in a concentration of more than 0.1% per weight. At the time of release of this product, except for the lead substance, no other substances of REACH candidate list are contained in a concentration of more than 0.1% per weight in this product.

Note: on June 27, 2018, lead was added to the REACH candidate list. The inclusion of lead in the REACH candidate list does not mean that lead-containing materials pose an immediate risk or results in a restriction of permissibility of its use.

SAFETY INSTRUCTIONS

1. READ these instructions.
2. KEEP these instructions.
3. HEED all warnings.
4. FOLLOW all instructions.
5. DO NOT use this apparatus near water.
6. CLEAN ONLY with dry cloth.
7. DO NOT block any ventilation openings. Install in accordance with the manufacturer's instructions.
8. DO NOT install near any heat sources such as radiators, heat registers, stoves, or other apparatus (including amplifiers) that produce heat.
9. DO NOT defeat the safety purpose of the polarized or grounding type plug. A polarized plug has two blades with one wider than the other. A grounding type plug has two blades and a third grounding prong. The wider blade or the third prong are outlet.
10. PROTECT the power cord from being walked on or pinched, particularly at plugs, convenience receptacles, and the point where they exit from the apparatus.
11. ONLY USE attachments/accessories specified by the manufacturer.
12.  USE ONLY with a cart, stand, tripod, bracket, or table specified by the manufacturer, or sold with the apparatus. When a cart is used, use caution when moving the cart/apparatus combination to avoid injury from tip-over.
13. UNPLUG this apparatus during lightning storms or when unused for long periods of time.
14. REFER all servicing to qualified service personnel. Servicing is required when the apparatus has been damaged in any way, such as power-supply cord or plug is damaged, liquid has been spilled or objects have fallen into the apparatus, the apparatus has been exposed to rain or moisture, does not operate normally, or has been dropped.
15. DO NOT expose this apparatus to dripping or splashing and ensure that no objects filled with liquids, such as vases, are placed on the apparatus.
16. To completely disconnect this apparatus from the AC Mains, disconnect the power supply cord plug from the AC receptacle.
17. Where the mains plug or an appliance coupler is used as the disconnect device, the disconnect device shall remain readily operable.
18. DO NOT overload wall outlets or extension cords beyond their rated capacity as this can cause electric shock or fire.
19. For adequate ventilation, do not install this equipment in a confined or enclosed space, such as a book case or similar unit.
20. Product ventilation should not be impeded by covering the ventilation openings with items such as newspaper, tablecloths, curtains, etc.



The exclamation point, within an equilateral triangle, is intended to alert the user to the presence of important operating and maintenance (servicing) instructions in the literature accompanying the product.



The exclamation point, within an equilateral triangle, is intended to alert the user to the presence of important operating and maintenance (servicing) instructions in the literature accompanying the product.

WARNING: To reduce the risk of fire or electrical shock, do not expose this apparatus to rain or moisture.

WARNING: No naked flame sources – such as lighted candles – should be placed on the product.

WARNING: Equipment shall be connected to a MAINS socket outlet with a protective earthing connection.

WARNING: This product is intended to be operated ONLY from the voltages listed on the back panel. Operation from other voltages other than those indicated may cause irreversible damage to the product and void the products warranty. The use of AC Plug Adapters is cautioned because it can allow the product to be plugged into voltages in which the product was not designed to operate. If you are unsure of the correct operational voltage, please contact your local distributor and/or retailer. If the product is equipped with a detachable power cord, use only the type provided, or specified, by the manufacturer or your local distributor.

OPERATING TEMPERATURE RANGE:

-20°C- 40°C (-4°F -104°F)



WARNING: Do Not Open! Risk of Electrical Shock. Voltages in this equipment are hazardous to life. No user-serviceable parts inside. Refer all servicing to qualified service personnel.

Place the equipment near a main power supply outlet and make sure that you can easily access the power breaker switch.

FCC AND CANADA EMC COMPLIANCE INFORMATION:

This device complies with Part 15 of the FCC Rules. Operation is subject to the following two conditions

1. This device may not cause harmful interference, and (2) this device must accept any interference received, including interference that may cause undesired operation.

CAUTION: Changes or modifications not expressly approved by the manufacturer could void the user's authority to operate this device.

NOTE: This equipment has been tested and found to comply with the limits for a Class B digital device, pursuant to Part 15 of the FCC Rules. These limits are designed to provide reasonable protection against harmful interference in a residential installation. This equipment generates uses and can radiate radio frequency energy and, if not installed and used in accordance with the instructions, may cause harmful interference to radio communications. However, there is no guarantee that interference will not occur in a particular installation. If this equipment does cause harmful interference to radio or television reception, which can be determined by turning the equipment off and on, the user is encouraged to try to correct the interference by one or more of the following measures: Reorient or relocate the receiving antenna. Increase the separation between the equipment and receiver. Connect the equipment into an outlet on a circuit different from that to which the receiver is connected. Consult the dealer or an experienced radio/TV technician for help.

SAFETY INSTRUCTIONS

CAUTION: This product is for non-residential use only.

WARNING: This equipment is compliant with Class B of CISPR 32. In a residential environment this equipment may cause radio interference.

CAN ICES-3 (B)/NMB-3(B)



Protective earthing terminal. The apparatus should be connected to a mains socket outlet with a protective earthing connection.

WIRELESS TRANSMITTER COMPLIANCE INFORMATION:

The term "IC:" before the radio certification number only signifies that Industry Canada technical specifications were met.

Le terme «IC:» avant le numero de certification radio signifie seulement que les specifications techniques d'Industrie Canada ont ete respectees.

This device contains licence-exempt transmitter(s)/receiver(s) that comply with Innovation, Science and Economic Development Canada's licence-exempt RSS(s). Operation is subject to the following two conditions (1) this device may not cause harmful interference, and (2) this device must accept any interference, including interference that may cause undesired operation of the device.

Cet appareil contient des émetteurs / récepteurs exemptés de licence conformes aux RSS (RSS) d'Innovation, Sciences et Développement économique Canada. L'exploitation est autorisée aux deux conditions suivantes : (1) l'appareil ne doit pas produire de brouillage, et (2) l'utilisateur de l'appareil doit accepter tout brouillage radioélectrique subi, même si le brouillage est susceptible d'en compromettre le fonctionnement.

This equipment complies with FCC and IC radiation exposure limits set forth for an uncontrolled environment. This equipment should be installed and operated with minimum distance 20cm between the radiator and your body. This transmitter must not be co-located or operating in conjunction with any other antenna or transmitter.

Cet appareil est conforme a FCC et IC !'exposition aux rayonnements limites fixees pour un environnement non controle. Cet appareil doit etre installe et utilise avec une distance minimale de 20cm entre le radiateur et votre corps. Cet transmetteur ne doit pas etre cositue ou operant en liaison avec toute autre antenne ou transmetteur.

EU COMPLIANCE INFORMATION:

Hereby, HARMAN Professional, Inc., declares that the equipment type IRX100 Series is in compliance to the following:

European Union Restriction of Hazardous Substances Recast (RoHS2) Directive 2011/65/EU; European Union WEEE (recast) Directive 2012/19/EU; European Union Registration, Evaluation, Authorization and Restriction of Chemicals (REACH) Directive 1907/2006; European Radio Equipment Directive (RED) 2014/53/EU

You may obtain a free copy of the full Declaration of Conformity by visiting:

<http://www.jblpro.com/www/product-support/downloads>

This product contains batteries that are covered under the 2006/66/EC European Directive, which cannot be disposed of with normal household waste. Please follow local regulations.

WIRELESS FREQUENCY RANGE AND WIRELESS OUTPUT POWER:
2402MHz - 2480MHz
4.00mW

Prevention of hearing loss



Caution: Permanent hearing loss may occur if earphones or headphones are used at high volume for prolonged periods of time.

Note: To prevent possible hearing damage, do not listen at high volume levels for long periods.

CLASS B PRODUCT:

警告

此为B级产品。在生活环境中，该产品可能会造成无线电干扰。在这种情况下，可能需要用户对干扰采取切实可行的措施。

ENVIRONMENTAL:



此标识适用于在中华人民共和国销售的电子信息产品。标识中间的数字为环保实用期限的年数。

DECLARATION OF CONFORMITY

EN 60065:2014 8th Ed.

Audio, video and similar electronic apparatus – Safety requirements

EN 62368-1:2014+A11:2017

Audio/video, information and communication technology equipment - Part 1: Safety requirements

EN 301489-1 V2.1.1

Electromagnetic Compatibility (EMC) standard for radio equipment and services; Part 1: Common technical requirements; Harmonized Standard covering the essential requirements of article 3.1(b) of Directive 2014/53/EU and the essential requirements of article 6 of Directive 2014/30/EU

EN 301489-17 V3.1.1

Electromagnetic Compatibility (EMC) standard for radio equipment and services; Part 17: Specific conditions for Broadband Data Transmission Systems; Harmonized Standard covering the essential requirements of article 3.1(b) of Directive 2014/53/EU

EN 300328 V2.1.1

Wideband transmission systems; Data transmission equipment operating in the 2,4 GHz ISM band and using wide band modulation techniques; Harmonized Standard covering the essential requirements of article 3.2 of Directive 2014/53/EU

EN62479:2010

Assessment of the compliance of low power electronic and electrical equipment with the basic restrictions related to human exposure to electromagnetic fields (10MHz to 300GHz)

EN 55032: 2015

Electromagnetic compatibility of multimedia equipment – Emission requirements, Class B

EN 55035:2017

Electromagnetic compatibility of multimedia equipment – Immunity requirements

EN 61000-3-2: 2014

Electromagnetic Compatibility Part 3. Limits Section 2. Limits for harmonic current emissions (equipment input current ≤ 16 A per phase)

EN 61000-3-3: 2013

Electromagnetic Compatibility Part 3. Limits Section 3. Limits for voltage fluctuations and flicker in low-voltage supply systems for equipment with rated current ≤ 16 A

QUICK SETUP GUIDE

Congratulations on your purchase of JBL Professional IRX100 Series loudspeakers! We know you are anxious to get up and running as fast as possible, which is why you are reading this section. The following will help you get set up as soon as possible.

Packaging Contents

Your IRX100 system should include the following:

- 1 x IRX100 speaker
- 1 x 2M (6.5ft) IEC Power Cable
- 1 x Quick Start Guide

Unbox it

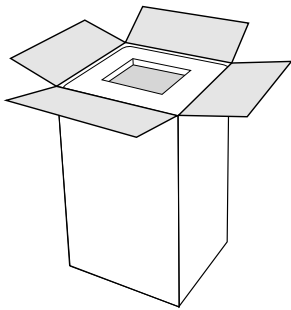

①

Open the top of the box.

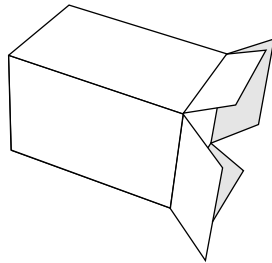

②

Lay box on its side.

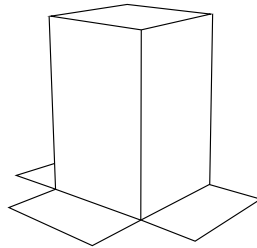

③

Turn box upside down, then lift box up to reveal speaker.

Configuration Options

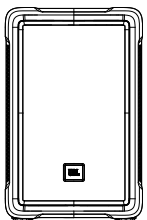

①

Floor Standing

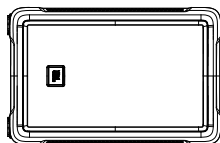

②

Monitor Position

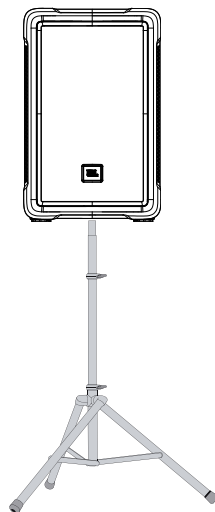

③

Pole Mounted

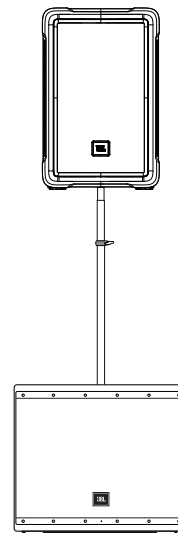

④

Subwoofer Mounted

QUICK SETUP GUIDE

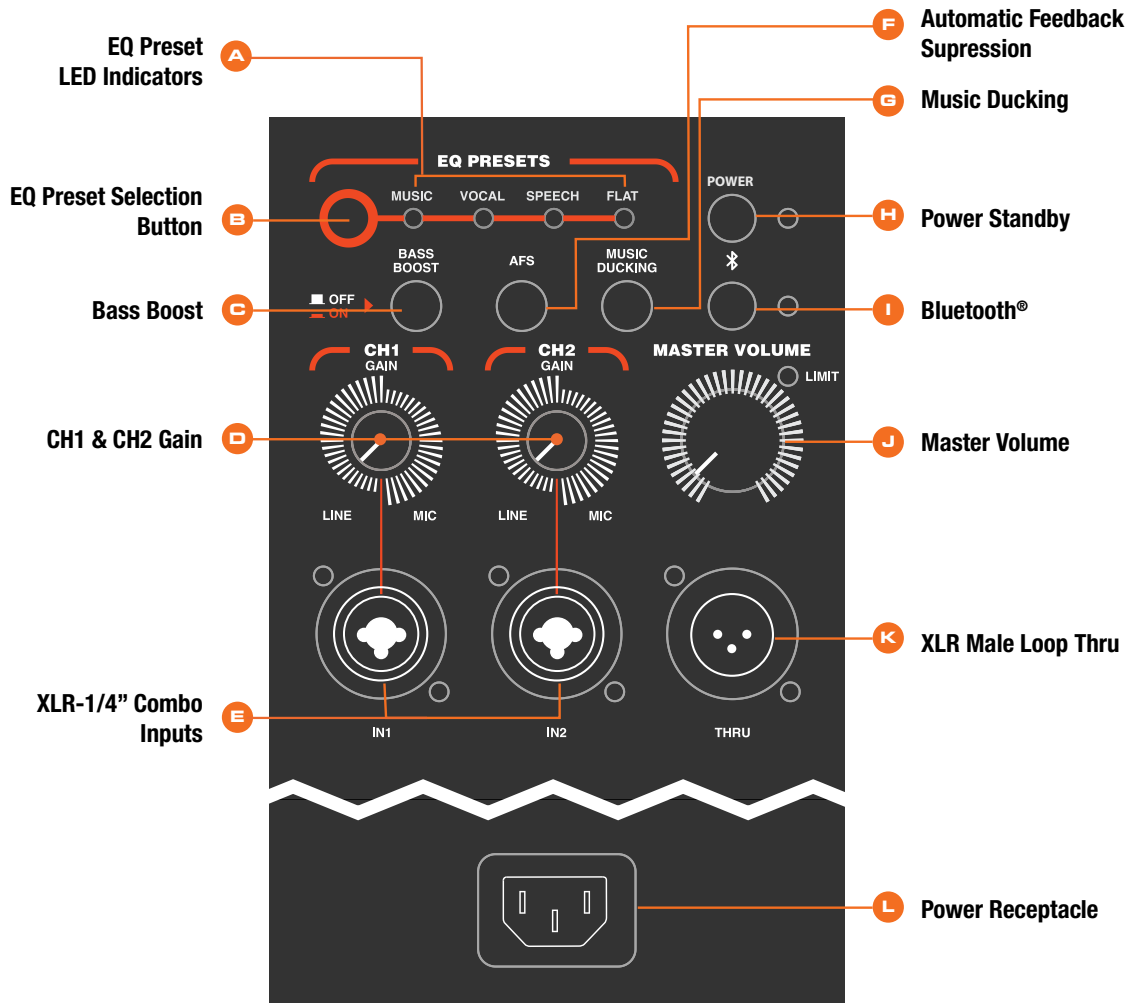

POWER IT ON

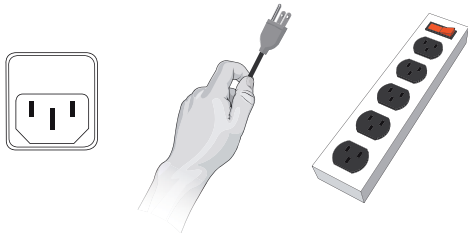

1. Connect the power cord to the Power Receptacle (L).
2. Press the Power Standby [H] switch for .5 of a second to engage power.

PLUG IN THE INPUTS

1. Turn the Master Volume Control (J) all the way to the left before connecting any inputs.
2. Connect your devices to the Input Jacks (E).

SET UP THE CHANNELS

1. Select a Preset using the EQ Preset Selection Button (B).
2. Determine the CH1 & CH2 Gain (D) source. For microphone set to 3 o'clock. For line source set to 9 o'clock.
3. Slowly turn the Master Volume (J) to the right until the desired volume is reached.

PAIR BLUETOOTH™ AUDIO

This device supports Bluetooth audio streaming.

To connect your device:

1. Turn on Bluetooth on your source device.
2. Hold the Bluetooth (I) button for 2 seconds. The LED will blink when the IRX Speaker is in pairing mode.
3. Find the desired IRX speaker on your device and select.

A. EQ Preset Selection Button

Use this button to toggle through the four different settings.

B. EQ Preset LED Indicators

MUSIC:

This is the default setting for the IRX loudspeakers. Use this setting when your IRX loudspeaker is being used either on a tripod or pole and facing towards your audience.

VOCAL:

Use this setting when your IRX loudspeaker is being used in conjunction with a separate subwoofer. This preset enables a High Pass Filter (HPF) set at 100Hz.

SPEECH:

Use this setting when your IRX loudspeaker is being used for Speech only or Spoken Word only applications and is facing towards the audience.

NORMAL:

Use this setting when your IRX loudspeaker is being used as a stage monitor facing towards you.

C. Bass Boost

Increase the Bass volume.

D. CH1 & CH2 Gain

Controls the gain of CH1 & CH2 respectively. By turning the signal counter-clockwise you will be lowering the gain of your source material. By turning the control clockwise you will be increasing the gain.

E. XLR-1/4" Combo Inputs

These balanced inputs accept a standard XLR (female) connector and also a 1/4" TRS phone plug. A broad range of signals from microphones, audio mixing consoles and electronic musical instruments may be connected here. The sensitivity of these inputs are controlled by the MIC/LINE SWITCHES.

F. Automatic Feedback Suppression

dbx AFS stops feedback before it starts.

G. Music Ducking

One-touch ducking automatically lowers music volume when speech input is detected.

H. Power Standby

I. Bluetooth Indicator

This LED will illuminate blue to indicate that your Bluetooth connection is established.

J. Master Volume

Controls the master volume of the unit. By turning the knob counter-clockwise you will be lowering the overall volume of the speaker. By turning the control clockwise you will be increasing the overall volume of the speaker.

K. XLR Male Loop Thru

This XLR (male) output connector provides a method of sending audio out to an external source. If signal is present on both inputs, the inputs will be summed and sent out as a 50/50 mix.

L. Power Receptacle

Connect the supplied power cord to the power receptacle on the rear of the speaker. Connect the power cord to an available power outlet.

OVERVIEW - IRX100 SERIES FAMILY



IRX108-BT

**Powered 8" Portable
Speaker with Bluetooth®**

- 1300 Watt
- 17.4 lb (7.9 kg)
- 90° (horizontal) x 60°
(vertical) nominal



IRX112-BT

**Powered 12" Portable
Speaker with Bluetooth®**

- 1300 Watt
- 27.3 lb (12.4 kg)
- 90° (horizontal) x 60°
(vertical) nominal

Thank you for purchasing the new JBL IRX100 Series!

More than just another great JBL sound system, the new IRX100 Series is a true step forward in technology developed specifically to deliver the best sound possible regardless of its application. Completely rethinking how truly good an affordable self-contained, portable PA system can be, JBL engineers purposely designed and built the IRX100 Series from the ground up featuring JBL's advanced waveguide technology, JBL designed and manufactured transducers.

This total redesign of the IRX100 Series platform leverages the latest technologies in cabinet materials, acoustic science, transducer design and user friendliness that delivers the extraordinary quality of a high-end studio monitor in a fully professional, highly flexible, easy to use, portable system for today's working musicians and sound providers.

With proper care your IRX100 Series speakers should provide you with many years of flawless performance, and are flexible enough to be a part of your sound reinforcement system even as it grows in scope.

IRX108/112BT - BLOCK DIAGRAM

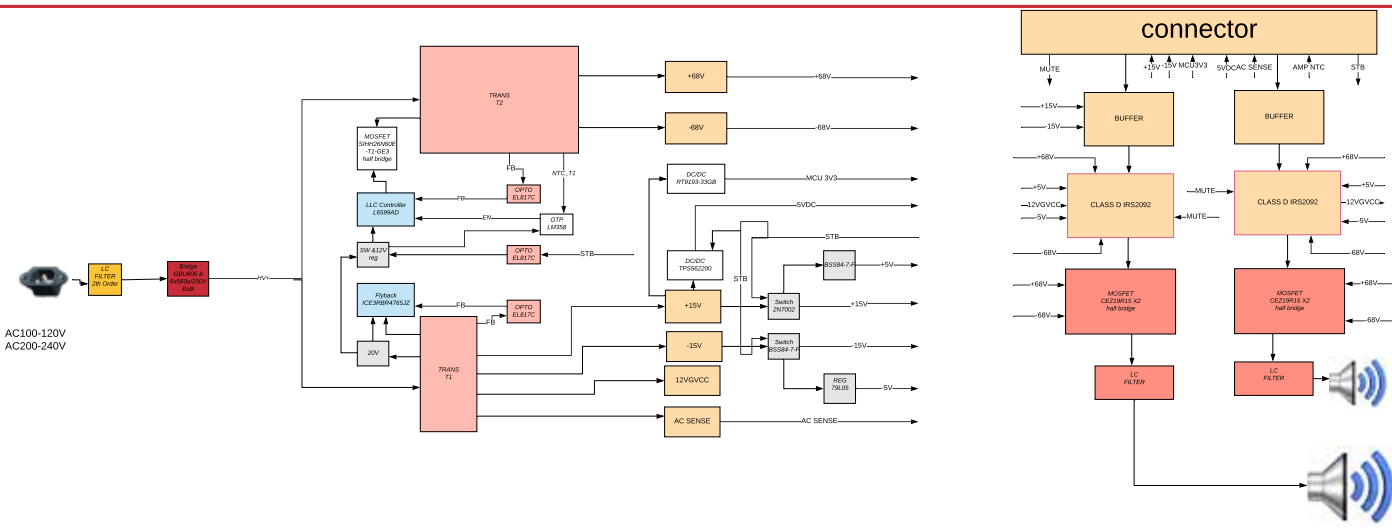
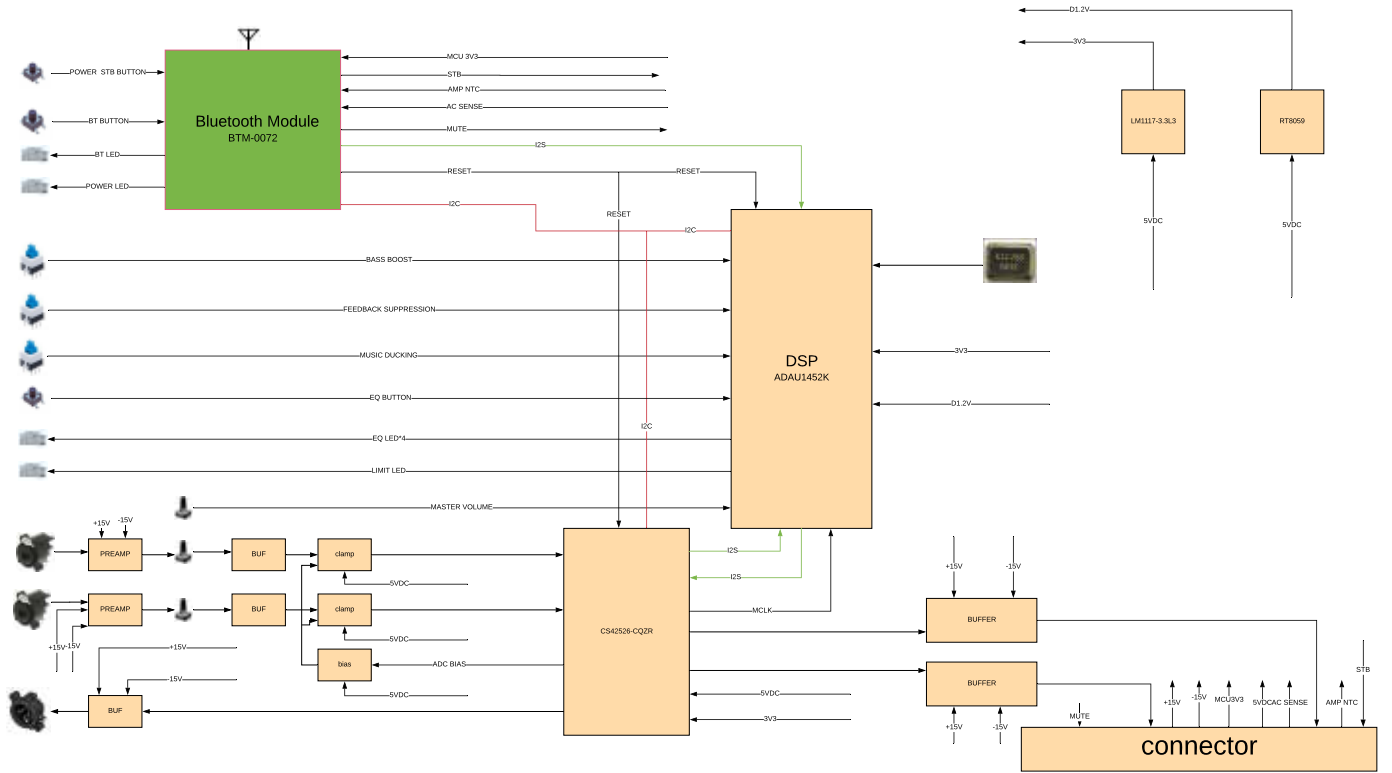

IRX108BT SPECIFICATIONS

TECHNICAL SPECIFICATIONS

SYSTEM TYPE:	Powered 8" two-way
CABINET:	Polypropylene with full grille
SENSITIVITY (SPL):	124 dB peak
FREQUENCY RESPONSE (± 3 dB):	54 Hz – 20 kHz
POWER RATING:	1300 watts peak
INPUT IMPEDANCE:	10k ohm balanced
COVERAGE PATTERN:	90° (horizontal) x 60° (vertical) nominal
BLUETOOTH:	Audio streaming, Bluetooth version 5.0
DSP:	4 presets, feedback suppression, ducking
I/O:	2 XLR/TRS combo mic/line inputs, 1 XLR pass-thru output 35 mm pole socket
MOUNTING:	17.4 lb (7.9 kg)
NET WEIGHT:	10.15 x 12.32 x 19.15 in
DIMENSIONS (D x W x H):	(258 x 313 x 486 mm)

ORDER SPECIFICATIONS

SHIPPING CARTON (L x W x H):	10.87 x 13.35 x 20.35 in (276 x 339 x 517 mm)
SHIPPING WEIGHT:	20.5 lb (9.3 kg)
UPC COD	691991033506

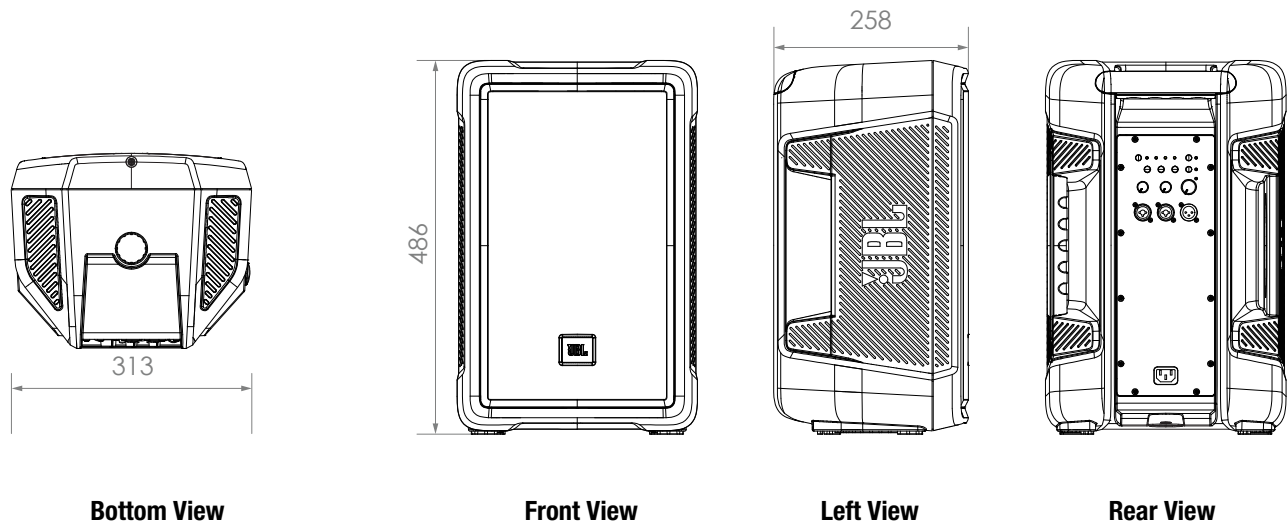

IRX112BT SPECIFICATIONS

TECHNICAL SPECIFICATIONS

SYSTEM TYPE:	Powered 12" two-way
CABINET:	Polypropylene with full grille
SENSITIVITY (SPL):	127 dB peak
FREQUENCY RESPONSE (± 3 dB):	53 Hz – 20 kHz
POWER RATING:	1300 watts peak
INPUT IMPEDANCE:	10k ohm balanced
COVERAGE PATTERN:	90° (horizontal) x 60° (vertical) nominal
BLUETOOTH:	Audio streaming, Bluetooth version 5.0
DSP:	4 presets, feedback suppression, ducking
I/O:	2 XLR/TRS combo mic/line inputs, 1 XLR pass-thru output 35 mm pole socket
MOUNTING:	27.3 lb (12.4 kg)
NET WEIGHT:	11.77 x 15.75 x 24.35 in
DIMENSIONS (D x W x H):	(299 x 400 x 618.4 mm)

ORDER SPECIFICATIONS

SHIPPING CARTON (L x W x H):	12.64 x 16.61 x 25.59 in (321 x 422 x 650 mm)
SHIPPING WEIGHT:	32 lb (14.51 kg)
UPC COD	691991033544

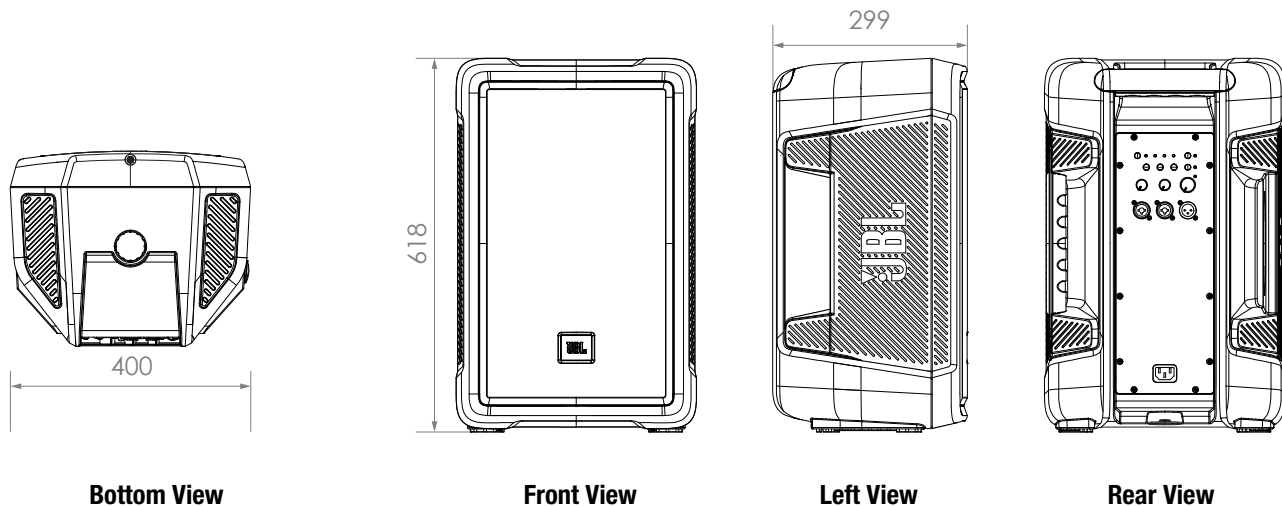

Bottom View

Front View

Left View

Rear View

APPLICATIONS / FEATURES

MUSICIANS/PERFORMERS

Musicians and performers looking for a great-sounding, easy-to-use sound reinforcement speaker in a portable, affordable package.

PRESENTERS/INSTRUCTORS

Mobile presenters and fitness instructors looking for an easy-to-use, compact PA solution with Bluetooth audio and built-in music ducking.

HOSPITALITY/GOVERNMENT INSTALLATIONS

Hospitality/government installations requiring professional sound quality with ease of use and minimal setup time.

FEATURES

- Four real-world EQ presets take the guesswork out
- dbx AFS stops feedback before it starts
- Bluetooth integration allows stereo streaming of music, soundtracks and backing tracks
- One-touch ducking automatically lowers music volume when speech input is detected
- Wide frequency response: 53 Hz – 20 kHz
- Lightweight design
- Wattage: 1300W
- 2 XLR/TRS combo input jacks and 1 XLR out offer a range of connectivity choices
- Input accepts mic or line source to enhance versatility
- Ergonomic handles make transport quick and easy
- Durable honeycomb steel grille is road-tested for reliability
- Built-in pole mount expands system set-up options

MUSIC DUCKING / AUTOMATIC FEEDBACK SUPPRESSION

Music Ducking

Soundcraft®-designed ducking automatically attenuates music when speech is detected.

- Press the “Music Ducking button.”
- Plug a microphone into the desired Channel output.
- Pair a BT device to the speaker.
- Turn the microphone gain up to the desired level.
- Ducking will now happen automatically.

Automatic Feedback Suppression

dbx® Automatic Feedback Suppression for trouble-free operation.

- To activate AFS (automatic feedback suppression), simply press the AFS button.

To clear AFS notch filters:

- With the AFS button pressed to ON, press and hold the Power button for 3 seconds. The EQ Preset LEDs for Vocal and Speech will light 3 times, indicating your filters have been reset.

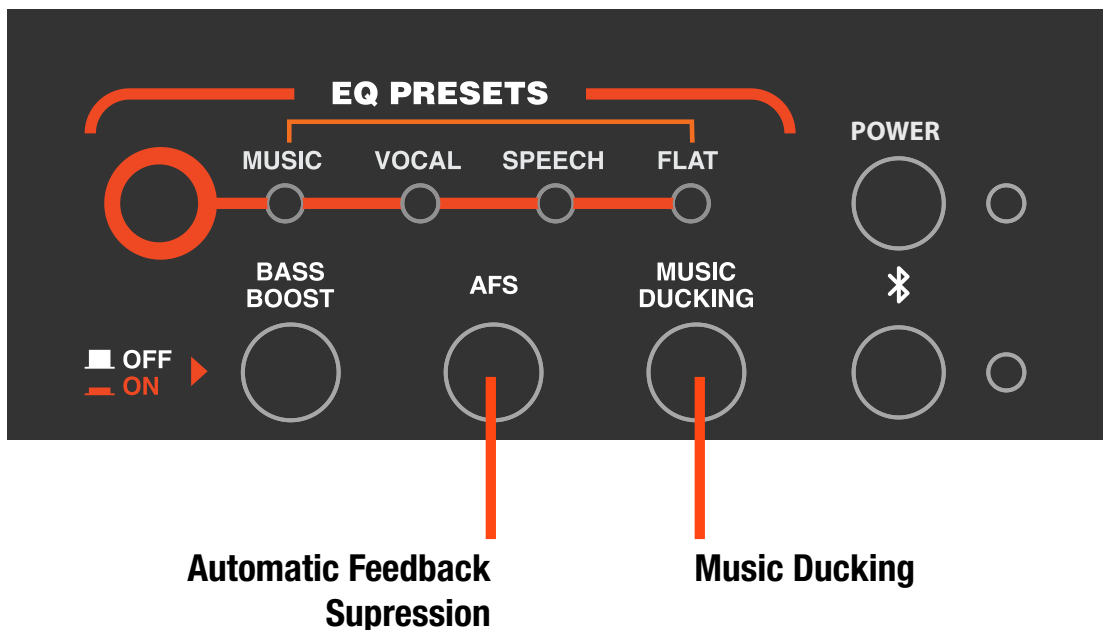

Sleep (Auto On/Off)

The IRX100 has a Sleep feature to help maintain the life of the speaker and conserve energy.

To enable/disable the Sleep feature:

- Ensure the speaker is powered OFF.
- Press and hold the Power button for 5s until LEDs flash.
 - If Sleep is disabled, the Power LED will light solid for 3s.
 - If Sleep is enabled, the Power LED will blink for 3s.

BLUETOOTH INTEGRATION

Streaming Bluetooth Audio

To pair a device to a single IRX speaker:

- Press the Bluetooth button for 2s until the light blinks slowly.
- Navigate to the Bluetooth settings of your device.
- Select the IRX speaker you wish to stream to.
- You will hear a connection tone when connection is successful.

To pair a device to two IRX speakers for true stereo operation:

1 A fresh start

- If previously paired, remove and forget both speakers from your device.
- On the first speaker, press and hold the Bluetooth button until all lights turn off and the Power light flashes (~10 seconds).
Note: After resetting, the EQ Preset will be set to "FLAT."
- Repeat for the second speaker.

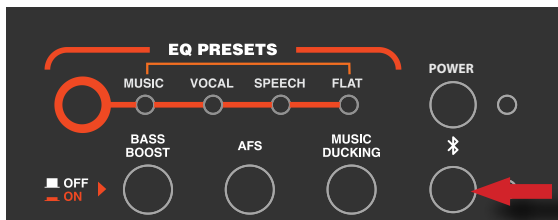

2 Pair the Right Speaker

- Go to the speaker to be designated as the Right speaker, then pair your device to this speaker by shortly pressing the Bluetooth button until the light flashes.

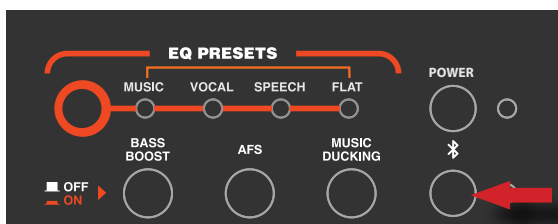

- On your device, find the IRX speaker under available Bluetooth devices and pair to it.



BLUETOOTH INTEGRATION

3 Link the Left speaker to the Right speaker

- On the Right speaker, press and hold the Bluetooth button until both the Power LED and the Bluetooth LED blink. An audio cue will be heard.
- Repeat the process on the Left speaker.
- Both Bluetooth and Power lights will continue to blink. After ~30 seconds, the speakers will pair to each other and an audio cue will be heard.

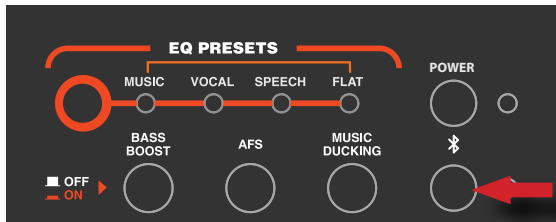

4 Verify paired status

- Notice on your device, under Bluetooth, the (Right) speaker paired status has changed:
 - On Android devices, the status changed from “Connected to media audio” to “Paired.”
 - NO action is required, continue to step 5.



- For iOS devices, the status changed from “Connected” to “Not Connected,” so we must reconnect before continuing to step 5...

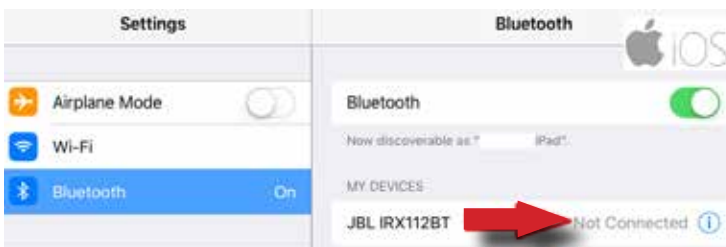

- ...simply tap/select the speaker to reconnect.

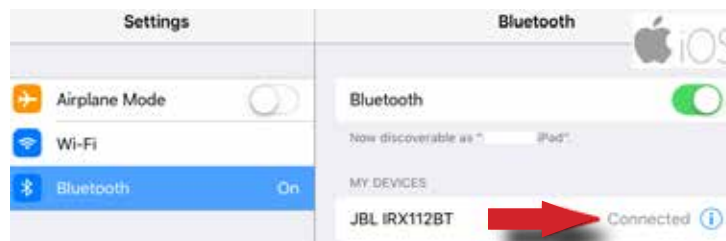

BLUETOOTH INTEGRATION

5 The final link

- Link the Left speaker to your device by shortly pressing the Bluetooth button, the light should flash.
- On your device, find the speaker under available Bluetooth devices and pair to it.
- Done! You now have true stereo sound.

Note: On your device under Bluetooth you will see both speakers:

- On Android, one displays as “Connected to media audio” and the other as “Paired.”



- On iOS, both are displayed as “Connected.”

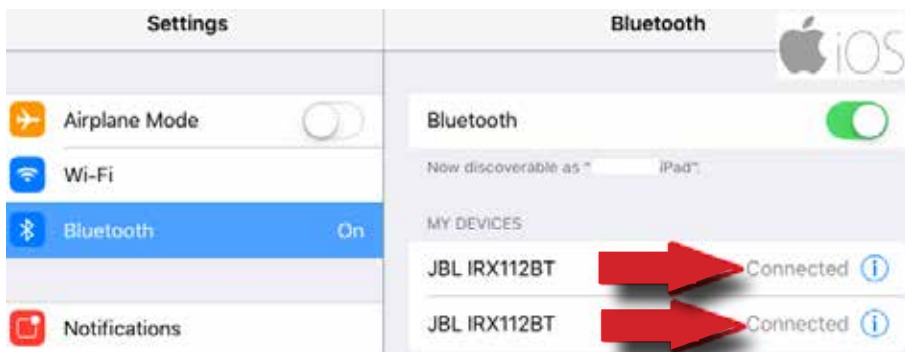

To exit true stereo Bluetooth streaming mode:

- Press and hold the BT button for 5 seconds until both the power LED and Bluetooth LED blink.
- Press the BT button again.
- The speakers are now unpaired.

LOUDSPEAKER PLACEMENT AND SUSPENSION

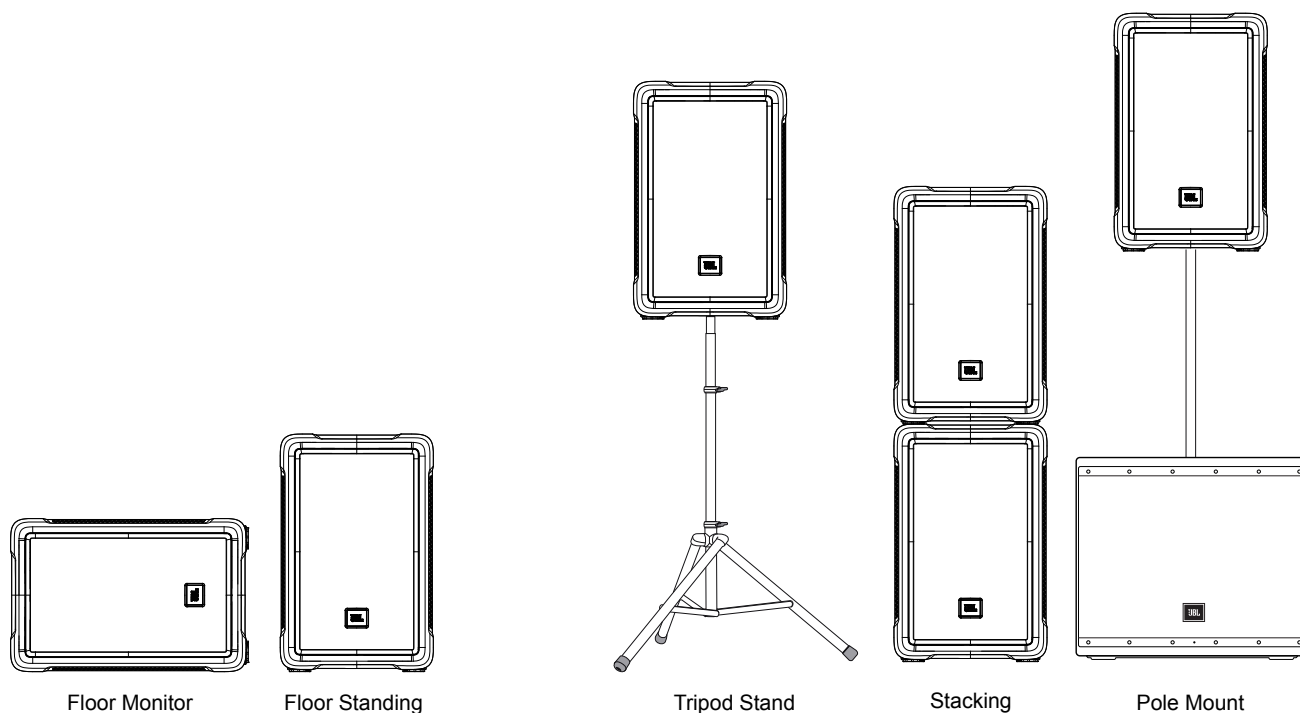

The following guidelines will help you achieve optimum sound wherever you use your IRX100 Series ® loudspeakers:

Raise the speakers as high as possible.

For best results try to get the high frequency horn at least 2 to 4 feet above the heads of the audience. If the speakers are too low, the people in the back of the audience will not receive the best quality sound.

Place the speakers between the microphones and the audience.

Feedback occurs when the microphones pick up sound from the speakers and “feed” the sound back through the sound system. If space is limited, point the speakers away from the microphones to reduce feedback.

Locate the speakers away from turntables.

Low-frequency feedback occurs when the output of the speaker is picked up by the tone arm of the turntable and is re-amplified. A heavy, solid turntable base and shock mounting can also reduce this type of feedback in DJ applications.

Use more speakers in large or highly reverberant spaces.

Spreading speakers throughout these spaces will produce much better sound than trying to compensate with loudness level or equalization. For very long distances, the use of another set of speakers with time delay is recommended.

Stand speakers upright for PA - Tilt the speakers back on the side for stage monitoring. Upright stance provides even coverage over a wide area. IRX Series speakers are also designed with two slanted positions for stage monitoring applications.

CABLES & CONNECTORS

XLR/F to XLR/M Microphone Cable	The standard cable for interconnection of microphone and line level signal in professional audio systems. • Microphone to mixer
TRS (balanced) 1/4 inch phone jack to XLR/M	For connecting balanced devices with 1/4 inch phone and maybe used interchangeably.
TRS (unbalanced) 1/4 inch phone jack to XLR/M	For connections of instruments with unbalanced outputs to balanced XLR inputs.
TS (unbalanced) 1/4 inch phone jack to XLR/M	This cable is electrically identical to "TRS" (unbalanced) 1/4 inch phone and may be used interchangeably.
XLR/M to RCA (phono) cable	Connects consumer audio products and some DJ mixer outputs to professional audio equipment inputs
TRS 1/4 inch Phone jack to dual 1/4 inch Phone jack	Splits a stereo output into separate left/right signals.
TRS 1/4 inch Phone jack to dual 1/4 inch Phone jack	Change to a TRS mini-phone jack to connect to the output of a portable. MP3/CD – player and computer sound cards to a mixer.
XLR/F to XLR/M audio ground lift	Only with balanced in - and outputs

XLR/F to XLR/M Microphone Cable

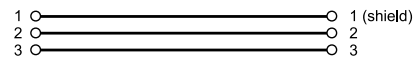

TRS (Balanced) 1/4" Phone to XLR/M Cable

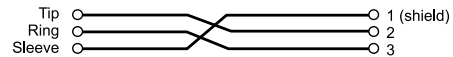

TRS (Unbalanced) 1/4" Phone to XLR/M Cable

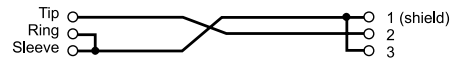

TS (Unbalanced) 1/4" Phone to XLR/M Cable

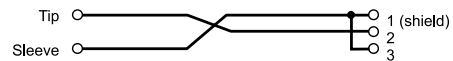

XLR/M to RCA (phono) Cable

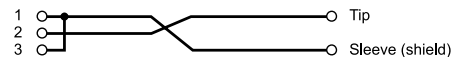

TS (Unbalanced) 1/4" Phone to RCA (phono) Cable

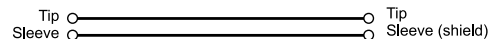

TRS 1/4" Phone to dual TS 1/4" Phone

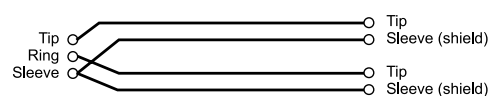

XLR/F to XLR/M Audio Ground Lift

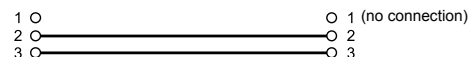
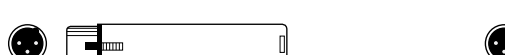

APPLICATION EXAMPLES

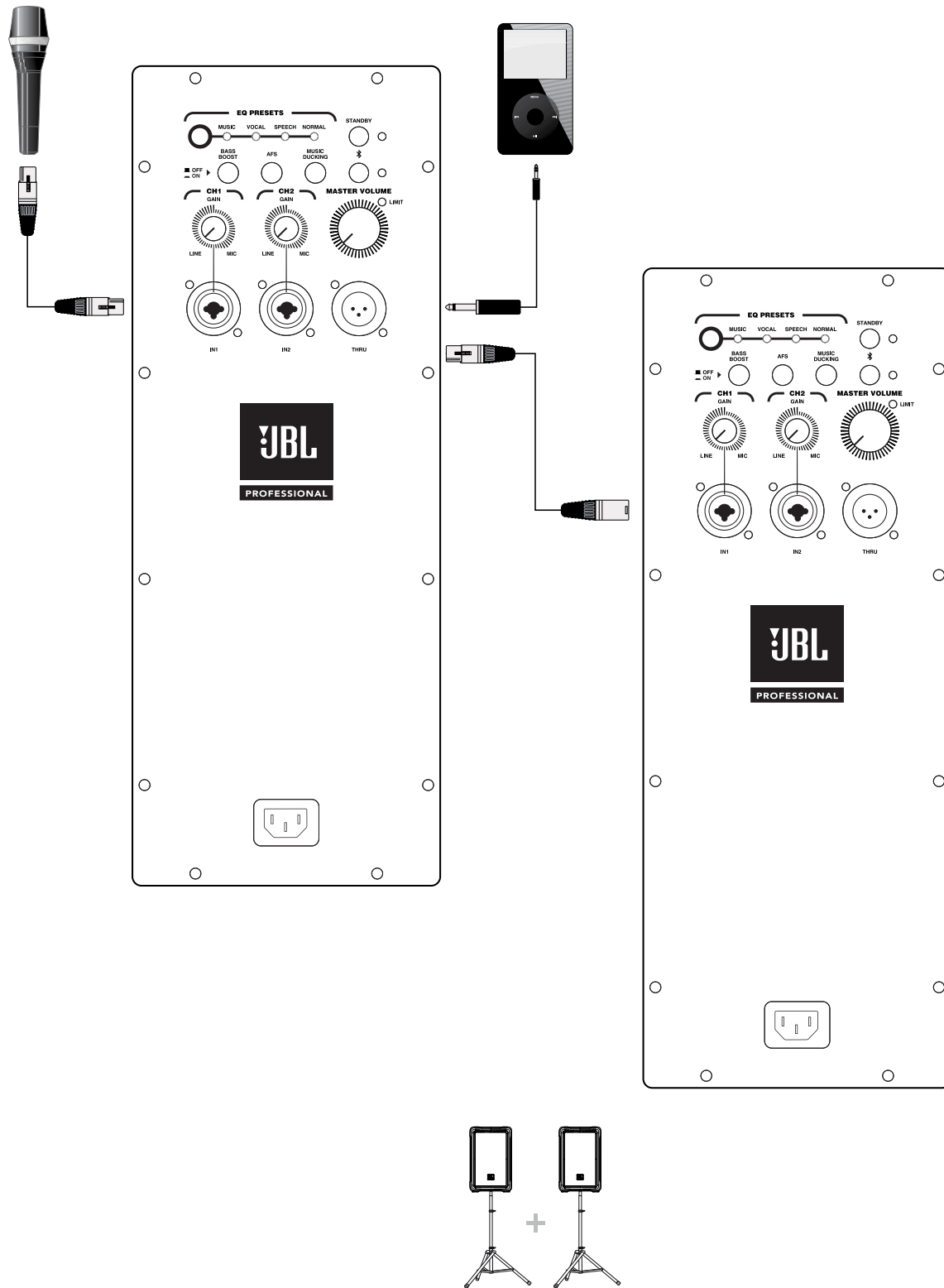

SMALL PA USING BOTH INPUTS AND THRU FUNCTION

CH1 input set to "Mic" CH2 input set to "Line"

Main Speaker Position

APPLICATION EXAMPLES

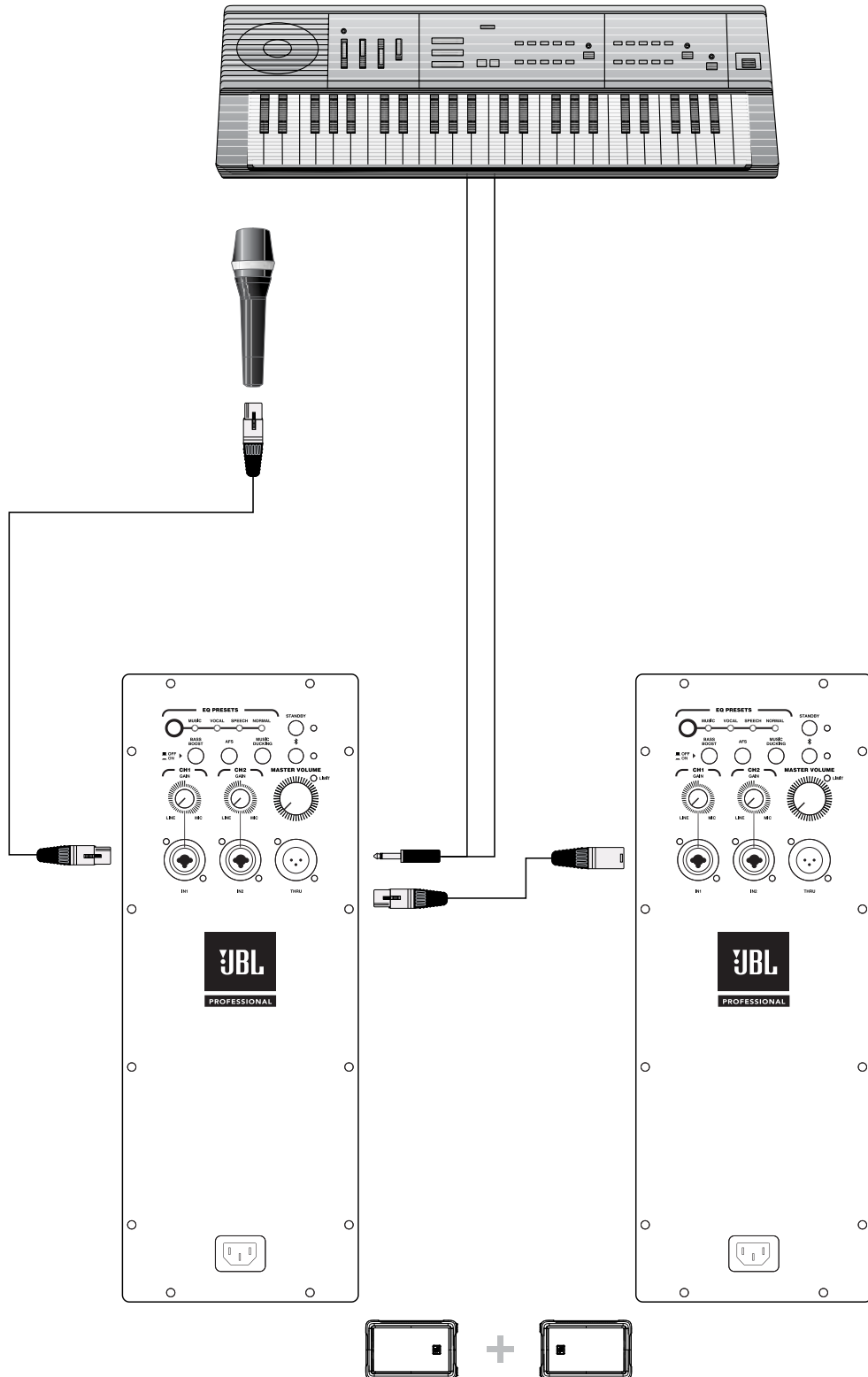

SMALL PA USING TWO SYSTEMS AS MONITORS

CH1 input set to "Mic" CH2 input set to "Line"

Monitor Speaker Position

TROUBLESHOOTING

Symptom	Likely Cause	What to do
No sound	Speaker not connected to active AC power	Verify that speaker is connected and that the circuit is on
	Power not switched on	Switch on power and verify that power LED is on
	Speaker in bypass mode	Twist any knob or press the bypass button to wake the speaker.
No sound, speaker is connected to working AC power but won't come on.	Speaker power cable is faulty or improperly connected.	<ul style="list-style-type: none"> • Re-seat the power cable at both ends. • Substitute a known-good power cable
No sound. Speaker comes on.	Signal source (mixer, instrument, etc.) is not sending.	<ul style="list-style-type: none"> • Check VU meters on the source mixer • Verify that the tape or CD is playing. • Use headphones to verify that the instrument is actually sending an audio signal
	Faulty cables and connections	<ul style="list-style-type: none"> • Disconnect and re-seat signal cables. • Replace suspected cable with a known-good cable
No sound with microphone connected directly to the MIC/ LINE input.	Microphone requires phantom power	The VE does not supply phantom power. Switch to a dynamic microphone, use a battery powered microphone (if possible), use an external phantom power supply for condenser type microphones.
Signal sounds distorted and very loud, PEAK light is lit most of the time.	Excessive input signal, trying to exceed the capabilities of the speakers	<ul style="list-style-type: none"> • Reduce the output level of the source. • Turn down the level controls on the speaker. • Use additional VE speakers.
Signal sounds distorted even at moderate volumes, LIMIT light is not lit.	Mixer or other source is overdriven	<p>Review the Owner's Manual for your mixer and adjust controls as needed.</p> <ul style="list-style-type: none"> • Input sensitivity (gain) • Channel faders • Master faders Once this is done, review the instructions in the Quick Start section of this guide.
Lots of hiss in the sound, the mixer controls are at very low settings.	Improper gain structure	<ul style="list-style-type: none"> • Make sure that the MIC/LINE switch is in the LINE (disengaged) position. • Mic/Line switch operation will be a little different. • Reduce the level settings at speaker. Review the Owner's Manual for your mixer and adjust controls as needed. • Input sensitivity (gain) • Channel faders • Master faders
Noise or hiss heard at output.	Noisy source device	Disconnect the devices that are connected to your speaker one at a time. If the noise goes away, the problem is with the source or the connecting cable.
Hum or Buzz that increases or decreases when the mixer level controls are moved.	Improper A/C ground or faulty equipment connected to mixer input	Disconnect or mute channels one at a time to isolate the problem. Refer to the owner's manual of the faulty equipment for troubleshooting help.
	Faulty cable between source equipment and mixer	Substitute a known-good cable for the suspected faulty cable.
Hum or Buzz	Improper A/C grounding, ground loops	<ul style="list-style-type: none"> • 'Lift' the audio ground by using an XLR/F to XLR/M adapter on one end. • Re-route audio cables away from AC power and lighting cables.
	Excessively long unbalanced cable run	<ul style="list-style-type: none"> • Use the balanced outputs (if available) of your mixer or source equipment to drive your IRX100 Series. • Use a "DI" (direct injection) box to convert your unbalanced equipment output to a balanced output.
	Improper system gain structure	Reduce the INPUT level controls and increase the output level of your source devices.

WARRANTY INFORMATION

The JBL Limited Warranty on professional loudspeaker products (except for enclosures) remains in effect for five years from the date of the first consumer purchase. JBL amplifiers are warranted for three years from the date of original purchase. Enclosures and all other JBL products are warranted for two years from the date of original purchase.

Who Is Protected By This Warranty?

Your JBL Warranty protects the original owner and all subsequent owners so long as: A.) Your JBL product has been purchased in the Continental United States, Hawaii or Alaska. (This Warranty does not apply to JBL products purchased elsewhere except for purchases by military outlets. Other purchasers should contact the local JBL distributor for warranty information.); and B.) The original dated bill of sale is presented whenever warranty service is required.

What Does The JBL Warranty Cover?

Except as specified below, your JBL Warranty covers all defects in material and workmanship. The following are not covered: Damage caused by accident, misuse, abuse, product modification or neglect; damage occurring during shipment; damage resulting from failure to follow instructions contained in your Instruction Manual; damage resulting from the performance of repairs by someone not authorized by JBL; claims based upon any misrepresentations by the seller; any JBL product on which the serial number has been defaced, modified or removed.

Who Pays For What?

JBL will pay all labor and material expenses for all repairs covered by this warranty. Please be sure to save the original shipping cartons because a charge will be made if replacement cartons are requested. Payment of shipping charges is discussed in the next section of this warranty.

How To Obtain Warranty Performance

If your JBL product ever needs service, write or telephone us at JBL Incorporated (Attn: Customer Service Department), 8500 Balboa Boulevard, P.O. Box 2200, Northridge, California 91329 (818/893-8411). We may direct you to an authorized JBL Service Agency or ask you to send your unit to the factory for repair. Either way, you'll need to present the original bill of sale to establish the date of purchase. Please do not ship your JBL product to the factory without prior authorization. If transportation of your JBL product presents any unusual difficulties, please advise us and we may make special arrangements with you. Otherwise, you are responsible for transporting your product for repair or arranging for its transportation and for payment of any initial shipping charges. However, we will pay the return shipping charges if repairs are covered by the warranty.

Limitation of Implied Warranties

ALL IMPLIED WARRANTIES, INCLUDING WARRANTIES OF MERCHANTABILITY AND FITNESS FOR PARTICULAR PURPOSE, ARE LIMITED IN DURATION TO THE LENGTH OF THIS WARRANTY.

EXCLUSION OF CERTAIN DAMAGES

JBL'S LIABILITY IS LIMITED TO THE REPAIR OR REPLACEMENT, AT OUR OPTION, OF ANY DEFECTIVE PRODUCT AND SHALL NOT INCLUDE INCIDENTAL OR CONSEQUENTIAL DAMAGES OF ANY KIND. SOME STATES DO NOT ALLOW LIMITATIONS ON HOW LONG AN IMPLIED WARRANTY LASTS AND/OR DO NOT ALLOW THE EXCLUSION OF INCIDENTAL OR CONSEQUENTIAL DAMAGES, SO THE ABOVE LIMITATIONS AND EXCLUSIONS MAY NOT APPLY TO YOU. THIS WARRANTY GIVES YOU SPECIFIC LEGAL RIGHTS, AND YOU MAY ALSO HAVE OTHER RIGHTS, WHICH VARY, FROM STATE TO STATE.

JBL Professional

8500 Balboa Blvd. Northridge, CA 91329 USA

CONTACT INFORMATION



Mailing Address:

JBL Professional
8500 Balboa Blvd.
Northridge, CA 91329

Shipping Address:

JBL Professional
8500 Balboa Blvd., Dock 1
Northridge, CA 91329

(Do not return product to this address without first obtaining prior authorization from JBL)

Customer Service:

Monday through Friday
8:00am – 5:00pm
Pacific Coast Time in the U.S.A.

844.776.4899

www.jblproservice.com

On The World Wide Web:

www.jblpro.com

Professional Contacts, Outside the USA:

Contact the JBL Professional Distributor in your area.

A complete list of JBL Professional international distributors is provided at our U.S.A. website: www.jblpro.com

IRX100

S E R I E S