



# SHADOW

## 112HC (112HCT)

### APPLICATIONS

- Convention centers
- Athletic fields
- Stadiums
- Theme parks
- Swimming pools
- Cruise ships
- Malls
- Ballrooms
- Outdoor background music

### KEY FEATURES

- 2-way high performance 12" coax
- Sturdy molded polyethylene curved enclosure
- 12" woofer with 2.5" coil
- 1" HF driver with 1.7" coil
- Line transformer (model 112HCT)
- 4 wires cable to select the power tapping
- IP55 weather resistant
- Standard grey finish
- Completely manufactured in Italy

### ALL WEATHER LOUDSPEAKERS



Designed, Engineered  
and Manufactured in ITALY

### PRODUCT DESCRIPTION

The SHADOW 112HC is a weatherproof coaxial two way loudspeaker system offering substantial power and efficiency for a variety of professional indoor or outdoor applications. The low frequency transducer is a 12" woofer with a 2.5" voice coil. The high frequency section is a 1" driver with 1.7" voice coil on 90°x60° rotatable horn. The SHADOW 112HCT features a line transformer for 70-100V applications. The cabinet is a single piece rotational moulded in polyethylene, fully UV protected. The cabinet is equipped with a stainless steel U-bracket. The grille is in custom perforated stainless steel with 3 layers of protection. The SHADOW 112HC meets the requirements of IP55 code ( International Protection Rating) .

### ELECTRONIC SPECIFICATIONS

System Type	2 Way
Recommended Amplifier	600W RMS
System Long Term Power	300W
System Short Term Power (IEC 268-5)	1200W
Transformer (optional)	100V / 200W/100W
Nominal Impedance	8 Ohm
Frequency Response	95Hz - 20kHz (@-6dB)
Sensitivity	101dB (@1W, 1m)
Max SPL (cont/peak) (bi-amp)*	128dB / 132dB
Dispersion	90°H x 60°V
Crossover Frequency	1.6kHz
Recommended HP Filter	70Hz - 24dB oct.

### PHYSICAL SPECIFICATIONS

Low Frequency Woofer	12" / 2.5" coil
High Frequency Driver	1" / 1.7" coil
Input Connectors	4 wire cable
Net Dimensions (WxHxD) inch	16.92 x 16.92 x 15.74
Shipping Dimensions (WxHxD) inch	20.86 x 20.86 x 19.68
Net Weight	46.3 lbs
Shipping Weight	50.7 lbs
Enclosure Material	Polyethylene rotomoulded
Grille	Custom perforated stainless steel

\* CONT. SPL: free space, based on recommended amp rating and LF transducer average sensitivity data, 125mS time average  
PEAK SPL: free space, based on short term applicable power rating and system peak sensitivity, 10mS time average



# SHADOW

## 112HC

### DIAGRAMS

Horizontal polar diagram

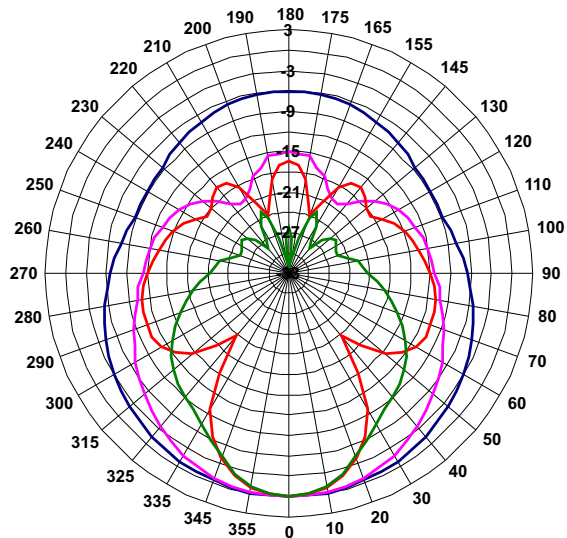
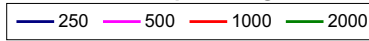

Horizontal polar diagram

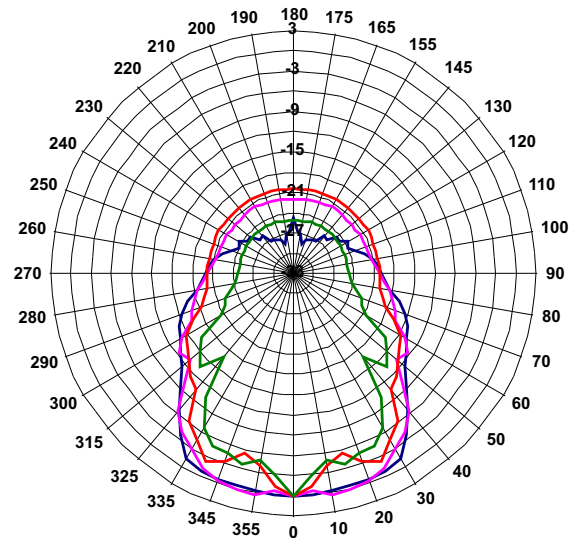
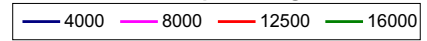

Horizontal coverage

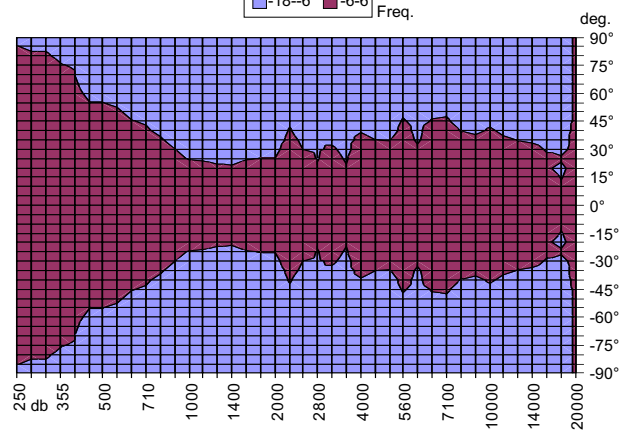
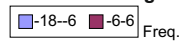



# SHADOW 112HC

## DIAGRAMS

Vertical polar diagram

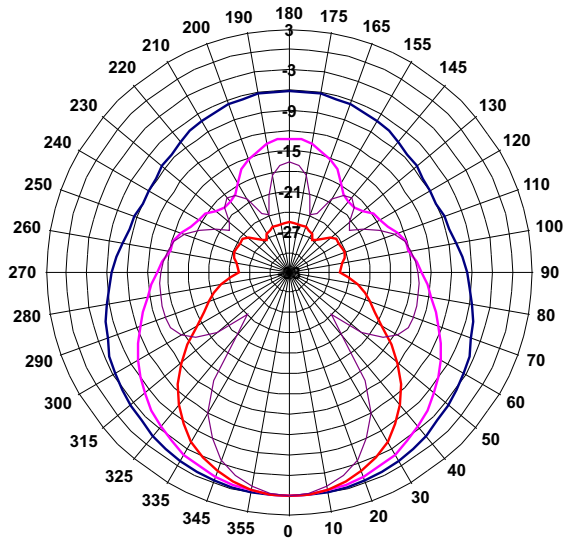
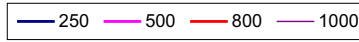

Vertical polar diagram

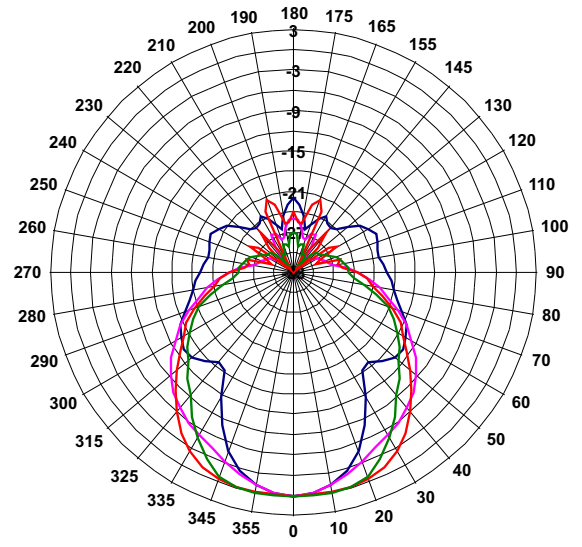
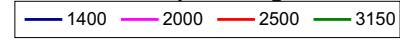

Vertical polar diagram

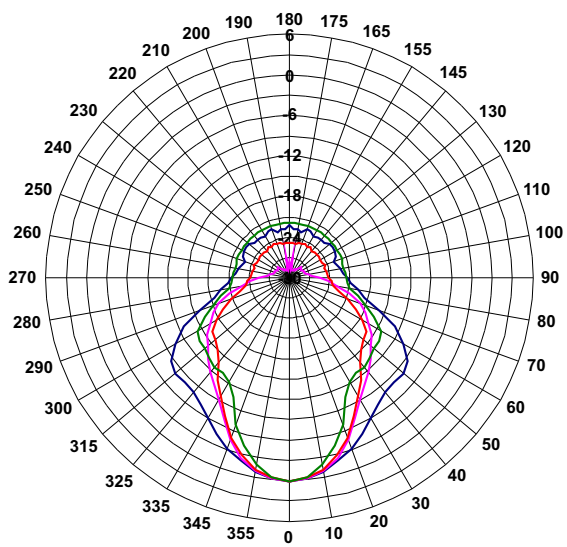
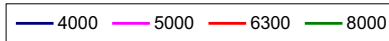

Vertical polar diagram

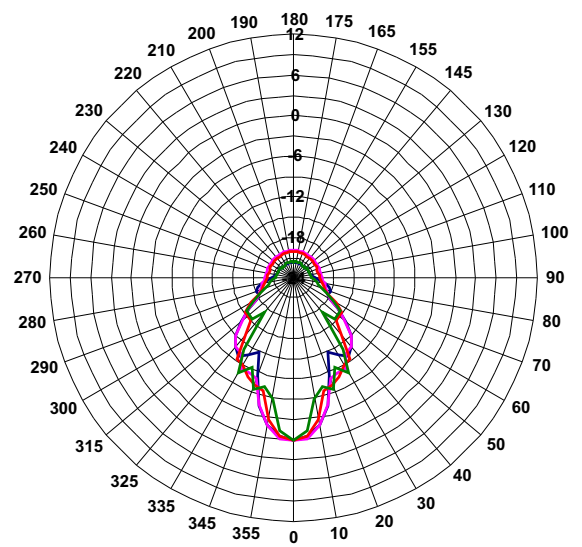
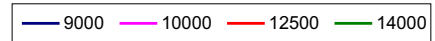

Vertical coverage

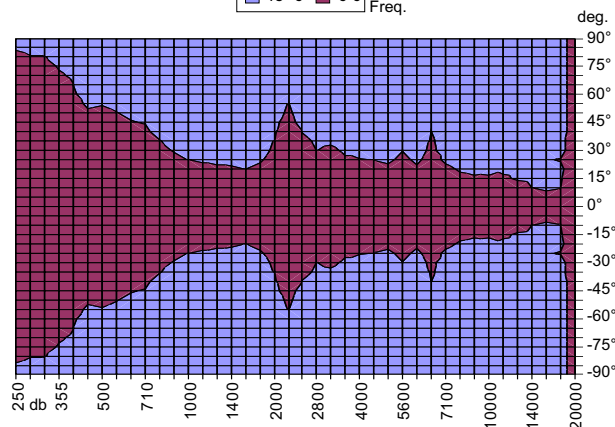



# SHADOW 112HC

## DIMENSIONAL DRAWINGS

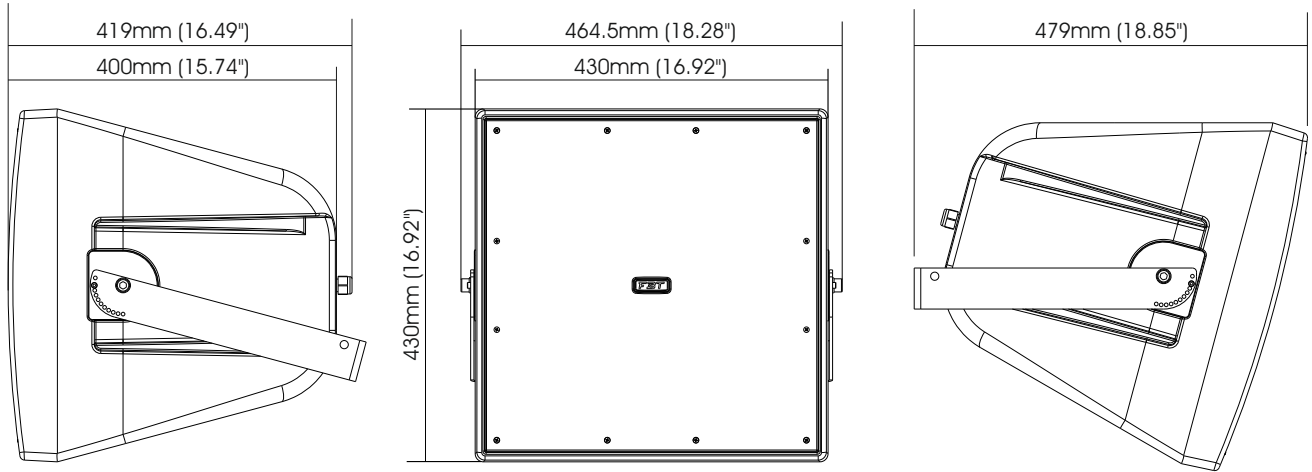

## TECHNICAL SPECIFICATIONS LABEL

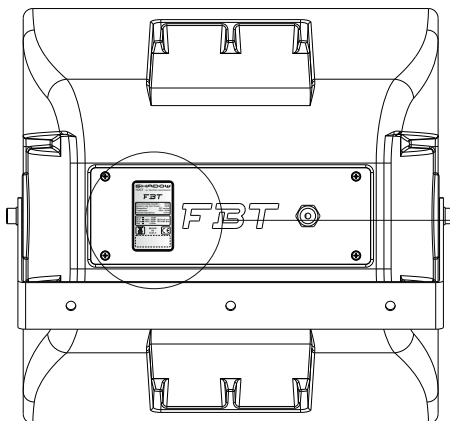

**SHADOW**  
112HCT ALL WEATHER LOUSPEAKERS

**FBT**

Recommended Amplifier: 600W  
System Long Term Power: 300W  
Dispersion: 90° x 60°  
Transformer: 100V / 200W  
Nominal Impedance: 8 Ohm

Black - COM  
Blue - 100V / 200W 70V=half pwr  
Brown - 100V / 100W 70V=half pwr  
Red - 8 Ohm

MADE IN ITALY

CE

## SUPPLIED ACCESSORY

