



MITUS

210M

APPLICATIONS

- Live sound reinforcement floor monitor
- Touring systems, Clubs, Auditoriums, Theatres
- Houses of worship, D.J. booth monitor

FEATURES

- 2-way bass reflex design with coaxial driver
- Recommended amplifier 800W RMS / 8Ohm
- 1 x 10" B&C custom neodymium magnet coaxial speaker with 2.5" voice coil
- 1.4" exit titanium compression driver with 2.5" voice coil
- B&C custom 10" neodymium magnet woofer with 2.5" voice coil
- 70° conical dispersion
- Input panel with 2 x Neutrik speakon NL-4MDV *in & link*
- SPL capability 132dB
- 5/8" birch plywood enclosure
- 1.38" stand socket
- Completely Manufactured in Italy

PASSIVE STAGE MONITOR



PRODUCT DESCRIPTION

The FBT MITUS 210M two-way passive stage monitor shall incorporate 1 x 10" B&C custom neodymium magnet coaxial speaker with 2.5" voice coil and 1.4" exit titanium compression driver with 2.5" voice coil (70° conical dispersion); B&C custom 10" neodymium magnet woofer with 2.5" voice coil. The FBT MITUS 210M shall meet the following performance criteria: Frequency response of 65Hz to 20kHz, Frequency sensitivity of 100dB, Maximum SPL of 132dB, Recommended power amplifier 800W RMS/8 Ohm. Hi-grade passive internal crossover featuring «soft-trip» circuitry protection of low frequencies and high frequencies. The front shall be protected by a heavy duty metal grille with anti-resonance spacers and exclusive synthetic cloth to protect the drivers and a rugged touring grade scratch resistant black paint finish protects the cabinet exterior. Input connectors shall be parallel wired Neutrik NL4 speakon. The FBT MITUS 210M feature 5/8" birch plywood construction and a 1.38" stand socket allows the FBT MITUS 210M to be mounted on speaker stand.

ELECTRICAL PERFORMANCE

System Type:	2-way
Recommended Amplifier	800W RMS
Long Term Power (AES)	400W
Short Term Power (IEC 268-5)	1600W
Nominal Impedance	8 Ohm LF / 8 Ohm HF
Frequency Response @ -6dB	65Hz - 20kHz
Sensitivity @ 1W, 1m	100dB
Maximum SPL *	CONT. 128dB PEAK 132dB
Dispersion	70° conical
Crossover Frequency	1.2 kHz
Recommended HP filter	50Hz-24dB oct.

PHYSICAL

Low Frequency Woofer	2 x 10" - 2.5" coil
High Frequency Driver	1 x 1.4" - 2.5" coil
Input Connectors	2 x Speakon NL4 in & thru
Net Dimensions (WxHxD)	22.6" x 11.4" x 15.8" 574 x 290 x 402mm
Shipping Dimensions (WxHxD)	26.57" x 15.55" x 20.07" 675 x 395 x 510mm
Net Weight	37.5 lbs / 17 kg
Shipping Weight	42.1 lbs / 19.1 kg
Enclosure Material	birch plywood

* CONT. SPL: free space, based on recommended amp rating and LF transducer average sensitivity data, 125mS time average
PEAK SPL: free space, based on short term applicable power rating and system peak sensitivity, 10mS time average



DIAGRAMS

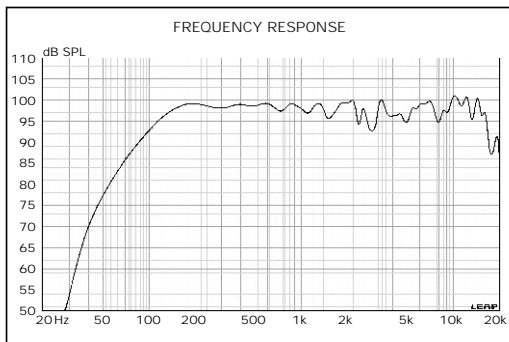
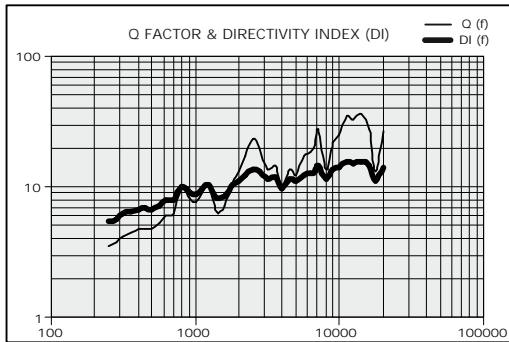
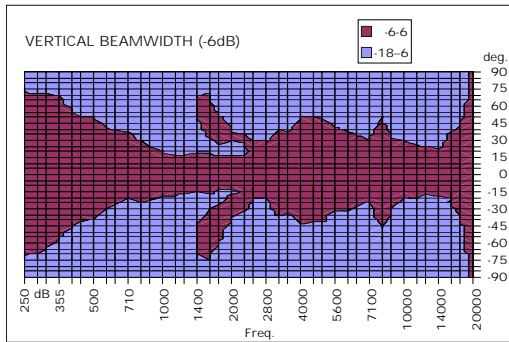
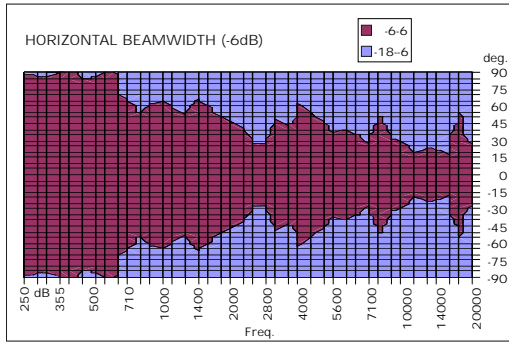

HORIZONTAL POLAR DIAGRAM

Legend: 250 (blue), 500 (red), 1000 (magenta), 2000 (green), 4000 (cyan), 8000 (orange), 12500 (purple), 16000 (dark green)

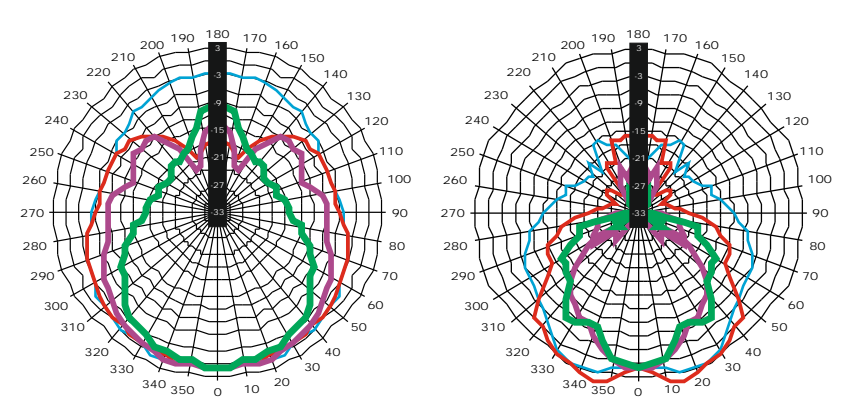

VERTICAL POLAR DIAGRAM

Legend: 250 (blue), 500 (red), 800 (magenta), 1000 (green), 1400 (cyan), 2000 (orange), 2500 (purple), 3150 (dark green)

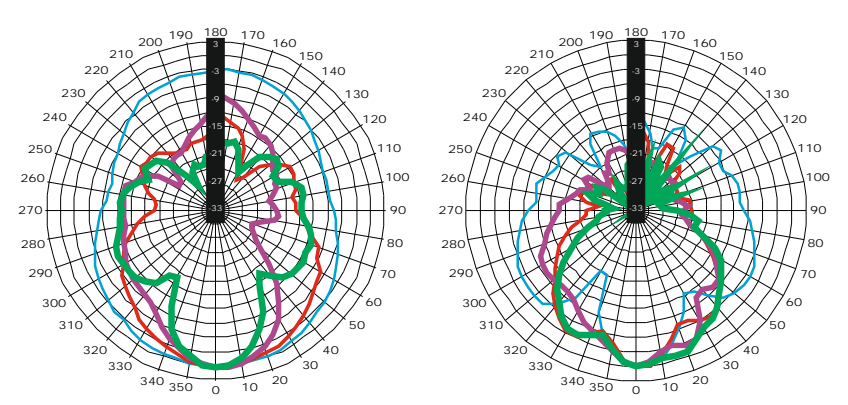

VERTICAL POLAR DIAGRAM

Legend: 4000 (blue), 5000 (red), 6300 (magenta), 8000 (green), 9000 (cyan), 10000 (orange), 12500 (purple), 14000 (dark green)

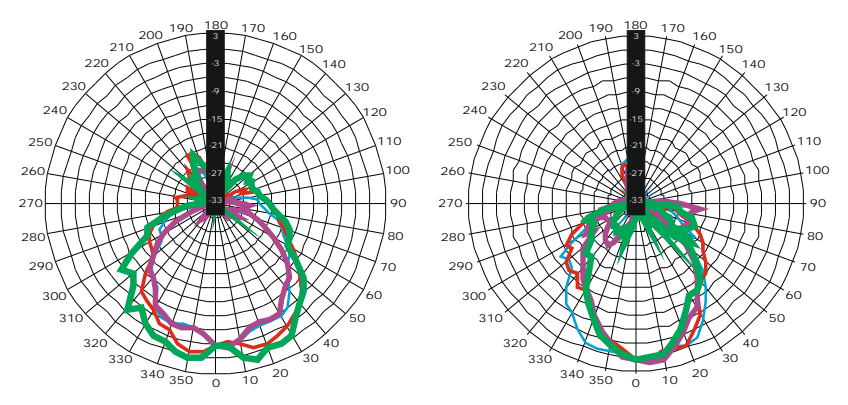



MITUS

210M

CONNECTORS

*SPEAKON is a registered trademark of NEUTRIK

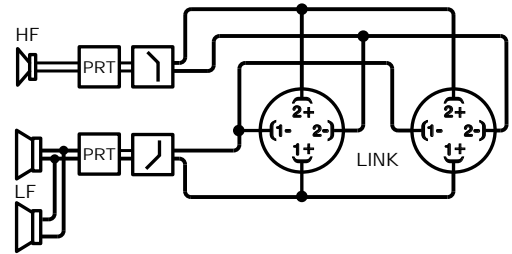

CONNECTION PANEL



FBT elettronica spa - RECANATI (MC) - MADE IN ITALY

MITUS

210M

Sound Reinforcement Stage Monitor

TECHNICAL SPECIFICATIONS

Nominal Impedance:	8 Ohm
Recommended Amplifier	800 W RMS
Short Term Power:	1600 W
Long Term Power:	400 W
Frequency Response (@-6dB):	65Hz - 20kHz
Sensitivity @1W,1m:	100 dB
Max SPL cont./peak:	128 / 132 dB
Dispersion:	70° conical

CAUTION:
IT IS IMPORTANT TO USE AN AMPLIFIER THAT DOES NOT EXCEED
800W RMS @ 8 OHM

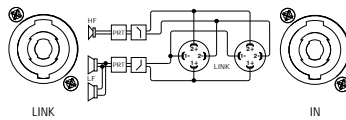

DIMENSION DRAWING

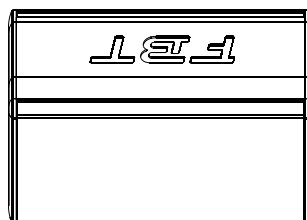
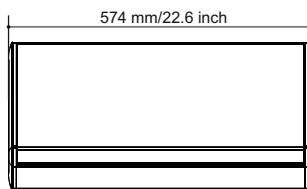
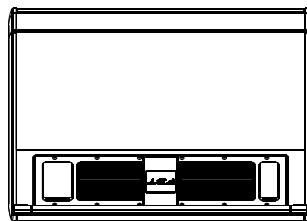
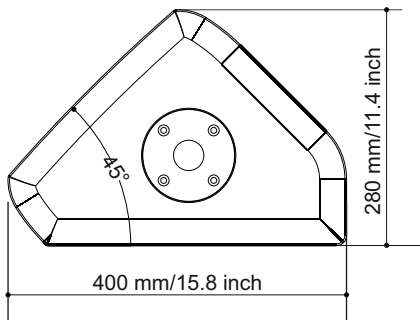

ACCESSORIES



BOX 62BK
Adjustable, for sub-satellite
speaker connection with
safety locking device
Ø35mm / 1.38"