

EQUINOX

Vapour 1000

User Manual



Order code: EQLED360

WARNING - FOR YOUR OWN SAFETY, PLEASE READ THIS USER MANUAL CAREFULLY BEFORE YOUR INITIAL START-UP!

- Before your initial start-up, please make sure that there is no damage caused during transportation.
- Should there be any damage, consult your dealer and do not use the equipment.
- To maintain the equipment in good working condition and to ensure safe operation, it is necessary for the user to follow the safety instructions and warning notes written in this manual.
- Please note that damages caused by user modifications to this equipment are not subject to warranty.



IMPORTANT:

The manufacturer will not accept liability for any resulting damages caused by the non-observance of this manual or any unauthorised modification to the equipment.

- Never let the power cable come into contact with other cables. Handle the power cable and all mains voltage connections with particular caution!
- Never remove warning or informative labels from the unit.
- Do not open the equipment and do not modify the unit.
- Do not switch the equipment on and off in short intervals, as this will reduce the system's life.
- Only use the equipment indoors.
- Do not expose to flammable sources, liquids or gases.
- Always disconnect the power from the mains when equipment is not in use or before cleaning! Only handle the power-cable by the plug. Never pull out the plug by pulling the power-cable.
- Make sure that the available mains supply voltage is 240V AC, 50Hz.
- Make sure that the power cable is never crimped or damaged. Check the equipment and the power cable periodically.
- If the equipment is dropped or damaged, disconnect the mains power supply immediately and have a qualified engineer inspect the equipment before operating again.
- If the equipment has been exposed to drastic temperature fluctuation (e.g. after transportation), do not connect power or switch it on immediately. The arising condensation might damage the equipment. Leave the equipment switched off until it has reached room temperature.
- If your product fails to function correctly, stop use immediately. Pack the unit securely (preferably in the original packing material), and return it to your Pro Light dealer for service.
- Only use fuses of same type and rating.
- Repairs, servicing and power connection must only be carried out by a qualified technician. THIS UNIT CONTAINS NO USER SERVICEABLE PARTS.
- This fixture is for professional use only - it is not designed for or suitable for household use. The product must be installed by a qualified technician in accordance with local territory regulations. The safety of the installation is the responsibility of the installer. The fixture presents risks of severe injury or death due to fire hazards, electric shock and falls.
- Warning! Risk Group 2 LED product according to EN 62471. Do not view the light output with optical instruments or any device that may concentrate the beam.
- WARRANTY: One year from date of purchase.

OPERATING DETERMINATIONS

If this equipment is operated in any other way, than those described in this manual, the product may suffer damage and the warranty becomes void. Incorrect operation may lead to danger e.g: short-circuit, burns and electric shocks etc.

Do not endanger your own safety and the safety of others!

Incorrect installation or use can cause serious damage to people and/or property.

Before filling the unit disconnect the mains. Never fill with hot liquids.

Only use high quality, water based smoke fluid recommended by the manufacturer.

Other smoke fluids may cause clogging and void the guarantee.

Always make sure there is sufficient smoke fluid in the tank. Operating this smoke machine without smoke fluid will cause damage to the pump as well as over heating of the heater.

Operate the unit only after you have familiarised yourself with its functions. Do not permit operation by persons not qualified for operating the unit and always drain the tank and use the original packaging if the unit is to be transported.

Vapour 1000

The Vapour 1000 hazer is capable of producing a room hanging haze in a matter of moments. The haze will emphasise the effects that lighting fixtures and spotlights create. The haze that this machine produces makes it possible to easily see the beams of light from your fixtures. The hazer features a fan and adjustable haze direction control so it doesn't blow one big plume of smoke onto the stage. The hazer can also be DMX controlled and comes supplied with an on-board control panel.



- 800W (max.) heater
- Smoke output: approx. 5,000 cu.ft per minute
- Warm-up time: approx. 2 min
- Tank capacity: 1.2 litres
- 4 push button menu with LED display
- 3-Pin XLR input/output
- IEC power input

Specifications	
Power consumption	800W (max.)
Power supply	240V, 50Hz
Fuse	F4A 250V
Dimensions	260 x 210 x 485mm
Weight	5.8kg
Order code	EQLD360

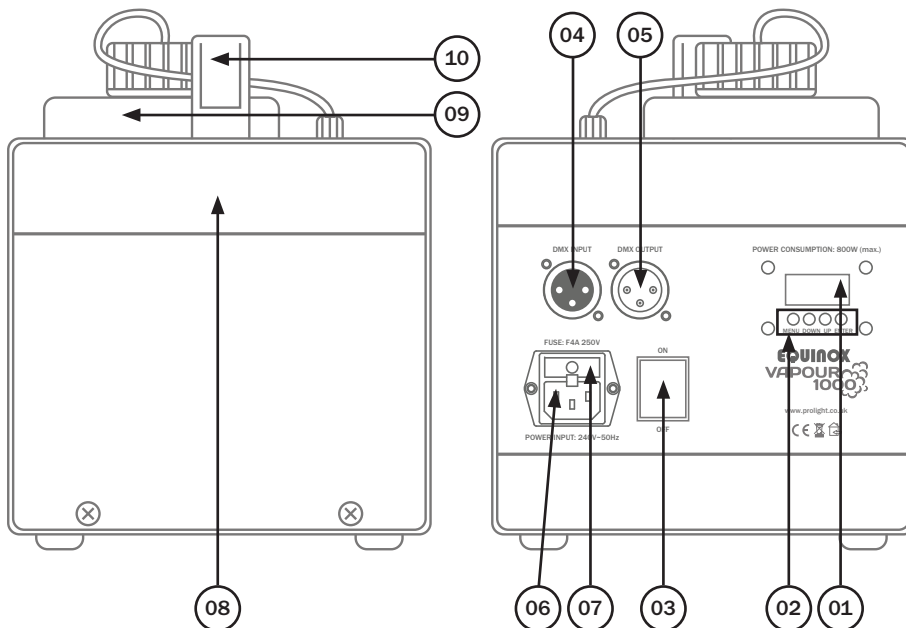
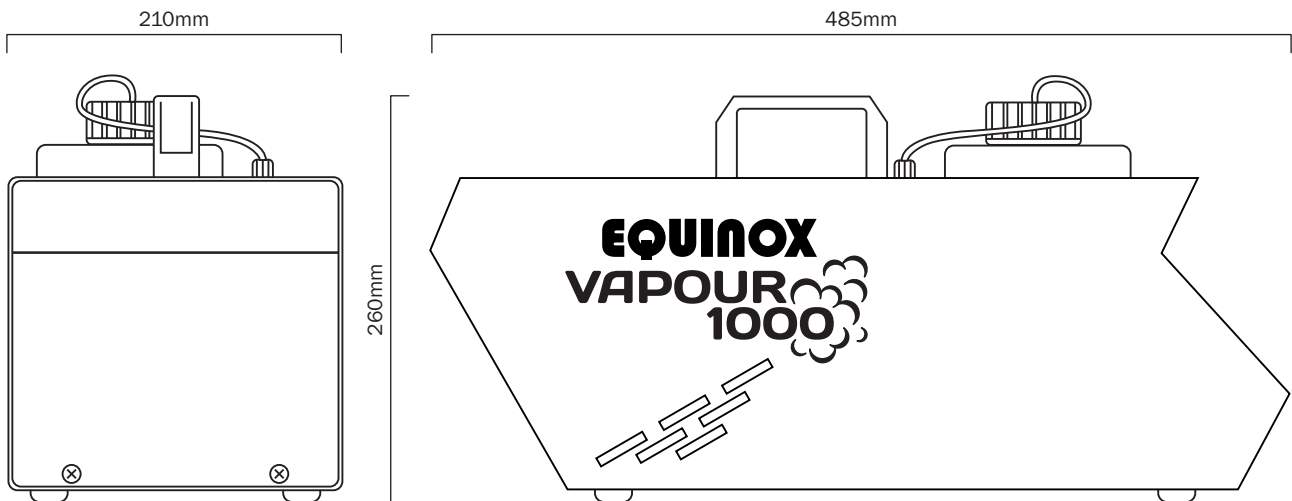

- 01 - LED display
- 02 - Function buttons
- 03 - Power on/off switch
- 04 - DMX input
- 05 - DMX output
- 06 - IEC power input
- 07 - Fuse F4A 250V
- 08 - Haze aperture
- 09 - Fluid tank
- 10 - Carry handle

In the box: **1 x fixture,**
1 x power cable &
1 x user manual

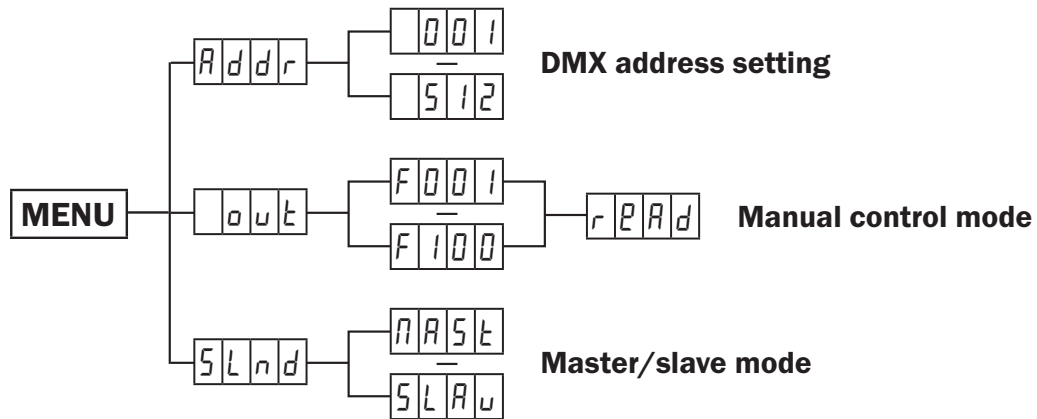

On startup the LED display on the rear of the unit will show *UP* whilst the unit is heating up.

DMX mode:

Operating in a DMX control mode environment gives the user the greatest flexibility when it comes to customising or creating a show. In this mode you will be able to control each individual trait of the fixture and each fixture independently.

To access the DMX address mode, press the “MENU” button on the rear of the unit to show *Addr* on the LED display. Now press the “ENTER” button and use the “UP” and “DOWN” buttons to set the required DMX address. Press the “ENTER” button to confirm the setting.

1 channel mode:

Channel	Value	Function
CH1	000-255	Haze output (0-100%)

Manual control mode:

To access the Manual control mode, press the “MENU” button on the rear of the unit to show *out* on the LED display. Now press the “ENTER” button and use the “UP” and “DOWN” buttons to choose the desired haze amount between *F001* ~ *F100*. Press the “ENTER” button to confirm the setting.

To suspend the haze output press and hold the “ENTER” button to show *rERd*. To resume the haze output press and hold the “ENTER” button again. The display will now show the last selected value.

To exit out of any of the above options, press the “MENU” button.

Value: 001 - 100 (001 = no haze output, 100 = maximum haze output)

Master/slave mode:

To set the unit in master/slave, press the “MENU” button on the front of the unit to show *SLnd* on the LED display. Now press the “ENTER” button and use the “UP” and “DOWN” buttons to select between *nASt* ~ *SLAr*. Press the “ENTER” button to confirm the setting.

To exit out of any of the above options, press the “MENU” button.

Starting operation:

Install the unit on a level surface.

The fluid tank of the unit needs to be filled with haze fluid before switching on.

Always disconnected it from the mains supply before filling as fluid could be spilled.

Only use quality haze fluids recommended by your dealer. You must not use substances which are classified as '**DANGEROUS WORKING MATERIALS**' or '**FLAMMABLE FLUIDS**'.

If fluid should get inside the main housing, disconnect the unit from the mains immediately and consult a technician.



Installation:

Install the unit in a well-ventilated area. Use in an insufficiently ventilated room can lead to the condensation of the haze fluid. The resulting slippery surface can cause accidents. Keep a minimum distance of 1m around the unit.

Furthermore do not orientate the output nozzle directly in the direction of the audience's eyes.

In order to create the best effect, there should be a distance between the unit and the audience of at least 1.5m.

Only install the haze machine on fire resistant, scratch resistant and water resistant surfaces.

	<p>DANGER OF FIRE!</p> <p>When installing the unit, make sure there is no highly flammable material (decoration articles etc) within a minimum distance of 1m</p>	
---	--	---

	<p>DANGER TO LIFE!</p> <p>Disconnect from the mains before starting maintenance</p>	
---	--	---

Cleaning and maintenance:

We recommend a frequent cleaning of the unit. Please use a soft lint-free and moistened cloth. Never use alcohol or solvents! Clean the output nozzle frequently from haze fluid residues. The fluids we recommend are non-hazardous to the environment and can be disposed of via the sewage system.

There are no serviceable parts inside this unit except for the fuse.

Maintenance and service operations are only to be carried out by authorized dealers.

Replacing the fuse:

Only replace the fuse with a fuse of same type and rating.

Before replacing the fuse, disconnect from the mains, see the following for procedure:

Step 1: Open the fuse holder on the rear panel with a suitable screwdriver.

Step 2: Remove the old fuse from the fuse holder.

Step 3: Install the new fuse in the fuse holder.

(Replacement fuses should be of the same value as originally supplied)

Step 4: Replace the fuse holder in the housing.

Should you need any spare parts, only use genuine parts.

If defective, please dispose of the unusable unit in accordance with the current legal regulations.

Should you have any further questions, please contact your dealer.



Correct Disposal of this Product (Waste Electrical & Electronic Equipment)

**(Applicable in the European Union and other European countries
with separate collection systems)**

This marking shown on the product or its literature, indicates that it should not be disposed of with other household wastes at the end of its working life. To prevent possible harm to the environment or human health from uncontrolled waste disposal, please separate this from other types of wastes and recycle it responsibly to promote the sustainable reuse of material resources.

Household users should contact either the retailer where they purchased this product, or their local government office, for details of where and how they can take this item for environmentally safe recycling.

Business users should contact their supplier and check the terms and conditions of the purchase contract. This product should not be mixed with other commercial wastes for disposal.



EQUINOX