

EQUINOX

Stage Haze 1500

User Manual



Order code: EQLED357

WARNING - FOR YOUR OWN SAFETY, PLEASE READ THIS USER MANUAL CAREFULLY BEFORE YOUR INITIAL START-UP!

- Before your initial start-up, please make sure that there is no damage caused during transportation.
- Should there be any damage, consult your dealer and do not use the equipment.
- To maintain the equipment in good working condition and to ensure safe operation, it is necessary for the user to follow the safety instructions and warning notes written in this manual.
- Please note that damages caused by user modifications to this equipment are not subject to warranty.



IMPORTANT:

The manufacturer will not accept liability for any resulting damages caused by the non-observance of this manual or any unauthorised modification to the equipment.

- Never let the power cable come into contact with other cables. Handle the power cable and all mains voltage connections with particular caution!
- Never remove warning or informative labels from the unit.
- Do not open the equipment and do not modify the unit.
- Do not switch the equipment on and off in short intervals, as this will reduce the system's life.
- Only use the equipment indoors.
- Do not expose to flammable sources, liquids or gases.
- Always disconnect the power from the mains when equipment is not in use or before cleaning! Only handle the power-cable by the plug. Never pull out the plug by pulling the power-cable.
- Make sure that the available mains supply voltage is 240V AC, 50Hz.
- Make sure that the power cable is never crimped or damaged. Check the equipment and the power cable periodically.
- If the equipment is dropped or damaged, disconnect the mains power supply immediately and have a qualified engineer inspect the equipment before operating again.
- If the equipment has been exposed to drastic temperature fluctuation (e.g. after transportation), do not connect power or switch it on immediately. The arising condensation might damage the equipment. Leave the equipment switched off until it has reached room temperature.
- If your product fails to function correctly, stop use immediately. Pack the unit securely (preferably in the original packing material), and return it to your Pro Light dealer for service.
- Only use fuses of same type and rating.
- Repairs, servicing and power connection must only be carried out by a qualified technician. THIS UNIT CONTAINS NO USER SERVICEABLE PARTS.
- This fixture is for professional use only - it is not designed for or suitable for household use. The product must be installed by a qualified technician in accordance with local territory regulations. The safety of the installation is the responsibility of the installer. The fixture presents risks of severe injury or death due to fire hazards, electric shock and falls.
- WARRANTY: One year from date of purchase.

OPERATING DETERMINATIONS

If this equipment is operated in any other way, than those described in this manual, the product may suffer damage and the warranty becomes void. Incorrect operation may lead to danger e.g: short-circuit, burns and electric shocks etc.

Do not endanger your own safety and the safety of others!

Incorrect installation or use can cause serious damage to people and/or property.

Before filling the unit disconnect the mains. Never fill with hot liquids.

Only use high quality, water based smoke fluid recommended by the manufacturer.

Other smoke fluids may cause clogging and void the guarantee.

Always make sure there is sufficient smoke fluid in the tank. Operating this smoke machine without smoke fluid will cause damage to the pump as well as over heating of the heater.

Operate the unit only after you have familiarised yourself with its functions. Do not permit operation by persons not qualified for operating the unit and always drain the tank and use the original packaging if the unit is to be transported.

Stage Haze 1500

A professional 1500W stage haze machine housed in a flight case. Fast warm-up time and a massive 6 litre fluid tank allow for long duration use between refills making it ideal for production and events. Easy to use LCD function display menu for control over timer, continuous haze and manual haze options.

- 1500W heater
- Output: approx. 12,000 cu.ft per minute (full on)
- Warm-up time: approx. 3 minutes
- Tank capacity: 6 litres
- DMX channels: 2
- Timer, manual and DMX modes
- 6 push button menu with LCD display
- PowerCON input
- 3-Pin XLR input/output
- 5-Pin XLR input/output



Housed in flightcase

Specifications	
Power consumption	1600W (max.)
Power supply	220~240V, 50/60Hz
Fuse	F8A 250V
Dimensions	265 x 575 x 423mm
Weight	19kg
Order code	EQLED357

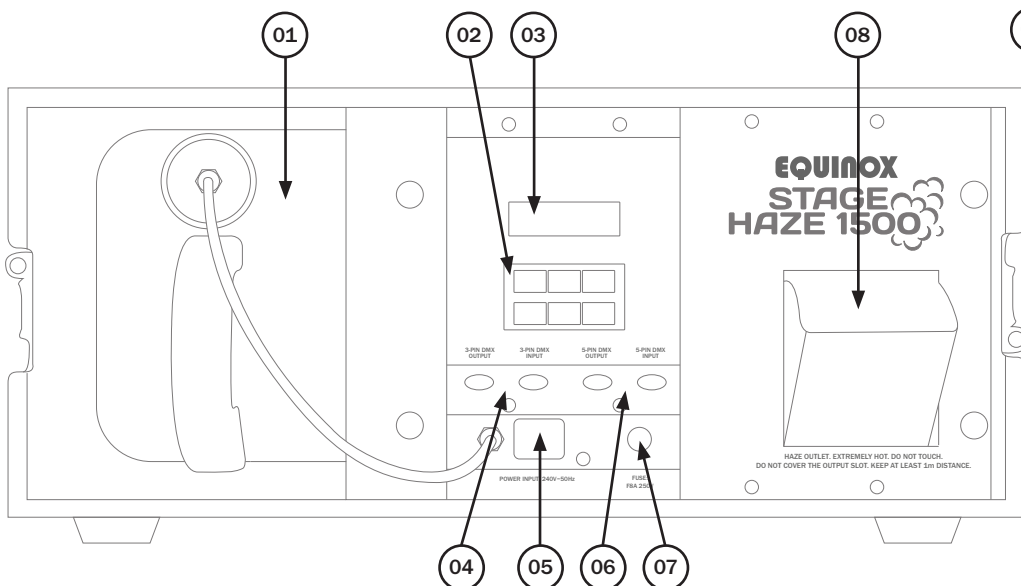
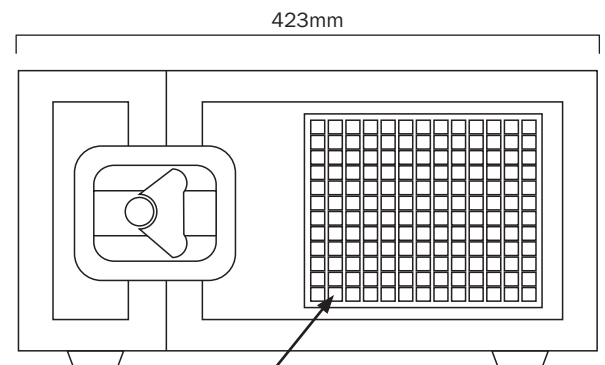
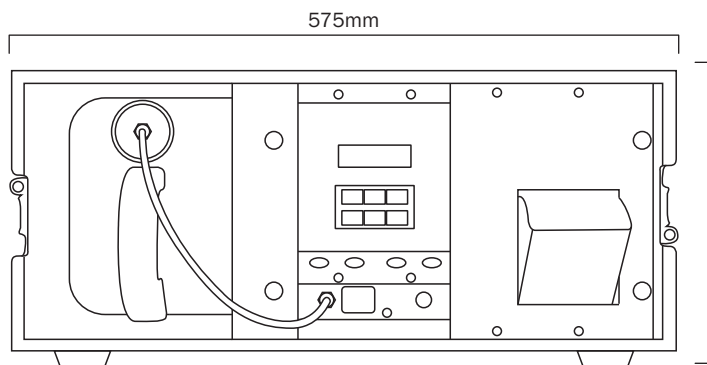

- 01 - Fluid tank
- 02 - Function buttons
- 03 - LCD display
- 04 - 3-Pin XLR input/output
- 05 - PowerCON input
- 06 - 5-Pin XLR input/output
- 07 - Fuse F8A 250V
- 08 - Haze aperture
- 09 - Air intake

In the box: **1 x fixture,**
1 x powerCON cable &
1 x user manual

Operation:

Place the unit on a level surface.

Always disconnect it from the mains supply before filling as fluid could be spilled.

Fluid replenishment:

Always fill the tank away from the unit to prevent fluid getting inside the main housing.

If fluid should get inside the main housing, disconnect the unit from the mains immediately and consult a technician.

Release pipe from top of bottle by pushing the metal collar towards the fluid tank. Then remove velcro strap securing tank and remove tank. Once out and away from unit, stand the tank upright so the cap is pointing towards the ceiling. Turn cap counter-clockwise to remove, then fill tank with fluid and replace cap turning clockwise until tight. Slide bottle back into the unit and secure with velcro strap. Then reattach the fluid pipe by pushing it into the metal collar on the fluid cap, making sure it clicks securely into position.

Installation:

Install the unit in a well-ventilated area. Use in an insufficiently ventilated room can lead to the condensation of the haze fluid. The resulting slippery surface can cause accidents. Keep a minimum distance of 1m around the unit.

Furthermore do not orientate the output aperture directly in the direction of the audience's eyes. In order to create the best effect, there should be a distance between the unit and the audience of at least 3m.

Only install the haze machine on fire resistant, scratch resistant and water resistant surfaces.



DANGER OF FIRE!

When installing the unit, make sure there is no highly flammable material (decoration articles etc) within a minimum distance of 1m

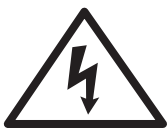

DANGER TO LIFE!

Disconnect from the mains before starting maintenance

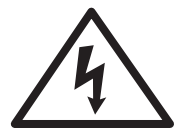





Only use quality haze fluids recommended by your dealer. You must not use substances which are classified as 'DANGEROUS WORKING MATERIALS' or 'FLAMMABLE FLUIDS'.



On startup the LCD display will show the heating percentage up to completion 'heating 0%' to 'heating 100%' whilst the unit is heating up and performing its startup clean cycle (approx. 3 minutes).



Once the heating up is finished it will then display 'Machine ready', which means the unit is ready for use.

Timer mode:

Press the "FUNCTION" button on the unit to display 'Wait Time Set Mode:', you can now adjust the interval time from 1s to 600s by using the  and  buttons.

Press the "FUNCTION" button to display 'Start Time Set Mode:', you can now adjust the haze output time from 1s to 600s by using the  and  buttons.

Press the "FUNCTION" button to display 'Timer Smoke Volume Out:', you can now adjust the output volume from 0% to 100% by using the  and  buttons.

Press the "FUNCTION" button to display 'Fan Adjusting Volume:', you can now adjust the fan volume from 0% to 100% by using the  and  buttons.

Once set you can then use the timer button to enable this mode.

The display will show

'Haze wait: ___S

Haze start: ___S'





with the settings already applied.

Press the  button once to stop haze output.

Manual mode:

Press the  button to start manual haze.

The display will show the current settings eg '*Haze 50% Fan 100%'.

You will notice an * will appear next to the word *Haze, you can now adjust the setting accordingly using the  and  buttons. If you want to adjust the Fan, simply press the FUNCTION button and the * will appear next to the word *Fan you can now adjust the setting accordingly using the  and  buttons.

Press the  button once to stop haze output.

Please note: This mode is for continuous haze.

button:

Press the  button until the LCD display shows 'Do not off in clean 300S'. The unit will now perform its cleaning cycle. Once the LCD display shows 'To turn off the POWER!!!', you can then disconnect the unit from the mains power supply.

DMX mode:

Operating in a DMX control mode environment gives the user the greatest flexibility when it comes to customising or creating a show. In this mode you will be able to control each individual trait of the fixture and each fixture independently.

Press the “**FUNCTION**” button to display ‘**The DMX device address set:**’, you can now adjust the DMX address from 1 to 511 by using the ▲ and ▼ buttons.

You can then connect the DMX controller, the display will show

‘**DMX-512 Add.:**’

‘**PMP: F:**’.

The PMP (haze output) and F (fan speed) can be adjusted via the DMX controller.

DMX channel mode:

Channel	Value	LCD display will show	Function
CH1	000-255	PMP (0-100%)	Haze output volume (0-100%)
CH2	000-255	F (0-100%)	Fan speed (slow-fast)

Electronic Fluid-level-sensor:

If the fluid runs out whilst the unit is in operation the unit will continue to operate for approx. 2 minutes, after this time the Electronic Fluid-level-sensor will stop the unit working to protect it. When this happens the LCD display will flash and show ‘**Beware: No Liquid!**’, this means the machine has run out of fluid, please refill.

When this happens please do the following:

Power off the unit and disconnect from mains power supply.

Refill the fluid tank. (See page 4 for instructions on fluid replenishment)

Reconnect the mains power supply.

The unit can now be operated again.

Troubleshooting:

When the LCD display flashes and shows ‘**Machine Temperature is too HIGH**’.

This could indicate the air filter on the side of the unit needs maintaining, please see page 7 for further instructions. Alternatively this could indicate that the PCB is faulty. If the problem persists, please contact your dealer.

When the LCD display flashes and shows ‘**Temperature sensor error**’.

This could indicate that the heater is faulty and is not heating up or the heater isn’t getting up to the right temperature. Please power the unit off and then back on. If the problem persists, please contact your dealer.

Cleaning and maintenance:

We recommend a frequent cleaning of the unit. Please use a soft lint-free and moistened cloth. Never use alcohol or solvents! Clean the output nozzle frequently from haze fluid residues. The fluids we recommend are non-hazardous to the environment and can be disposed of via the sewage system.

There are no serviceable parts inside this unit except for the fuse.

Maintenance and service operations are only to be carried out by authorised dealers.

Press the  button until the LCD display shows 'Do not off in clean 300S'. The unit will now perform its cleaning cycle. Once the LCD display shows 'To turn off the POWER!!!', you can then disconnect the unit from the mains power supply.

Air filter maintenance:

With prolonged use the air filter on the side of the flightcase can accumulate dust and dirt. You will periodically have to remove the side cover of the flightcase and remove the air filter to clean it. After cleaning, please make sure to dry the air filter thoroughly before installing it back into the unit and replacing the side cover.

Aperture sponge maintenance:

With prolonged use the sponge inside the output aperture may accumulate residue, please periodically clean the sponge, or replace with a new one if needed.

Replacing the fuse:

Only replace the fuse with a fuse of same type and rating.

Before replacing the fuse, disconnect from the mains, see the following for procedure:

Step 1: Open the fuse holder on the rear panel with a suitable screwdriver.

Step 2: Remove the old fuse from the fuse holder.

Step 3: Install the new fuse in the fuse holder.

(Replacement fuses should be of the same value as originally supplied)

Step 4: Replace the fuse holder in the housing.

Should you need any spare parts, only use genuine parts.

If defective, please dispose of the unusable unit in accordance with the current legal regulations.

Should you have any further questions, please contact your dealer.

Setting the DMX address:

The DMX mode enables the use of a universal DMX controller. Each fixture requires a “start address” from 1- 511. A fixture requiring one or more channels for control begins to read the data on the channel indicated by the start address. For example, a fixture that occupies or uses 7 channels of DMX and was addressed to start on DMX channel 100, would read data from channels: 100,101,102,103,104,105 and 106. Choose a start address so that the channels used do not overlap. E.g. the next unit in the chain starts at 107.

DMX 512:

DMX (Digital Multiplex) is a universal protocol used as a form of communication between intelligent fixtures and controllers. A DMX controller sends DMX data instructions from the controller to the fixture. DMX data is sent as serial data that travels from fixture to fixture via the DATA “IN” and DATA “OUT” XLR terminals located on all DMX fixtures (most controllers only have a data “out” terminal).

DMX linking:

DMX is a language allowing all makes and models of different manufactures to be linked together and operate from a single controller, as long as all fixtures and the controller are DMX compliant. To ensure proper DMX data transmission, when using several DMX fixtures try to use the shortest cable path possible. The order in which fixtures are connected in a DMX line does not influence the DMX addressing. For example; a fixture assigned to a DMX address of 1 may be placed anywhere in a DMX line, at the beginning, at the end, or anywhere in the middle. When a fixture is assigned a DMX address of 1, the DMX controller knows to send DATA assigned to address 1 to that unit, no matter where it is located in the DMX chain.

DATA cable (DMX cable) requirements (for DMX operation):

This fixture can be controlled via DMX-512 protocol. The DMX address is set on the back of the unit. Your unit and your DMX controller require a standard 3-pin XLR connector for data input/output, see image below.



Further DMX cables can be purchased from all good sound and lighting suppliers or Pro Light Concepts dealers.

Please quote:

CABL10 – 2m

CABL11 – 5m

CABL12 – 10m

Note: DMX cable must be daisy chained and cannot be split.

Notice:

Be sure to follow the diagrams below when making your own cables. Do not connect the cables shield conductor to the ground lug or allow the shield conductor to come in contact with the XLRs outer casing. Grounding the shield could cause a short circuit and erratic behaviour.

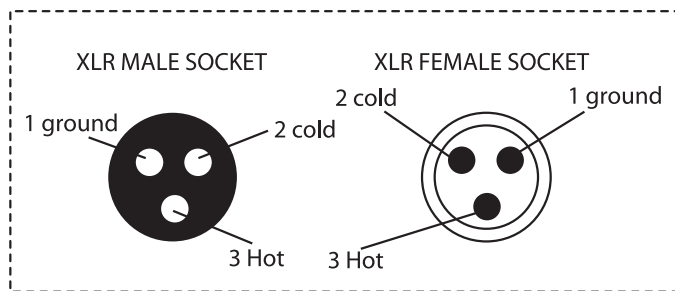
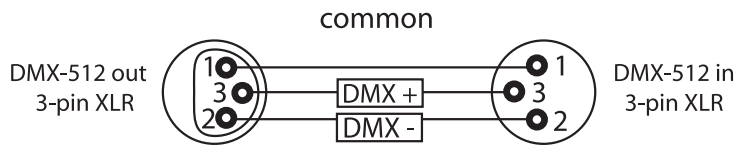

XLR Pin Configuration
Pin 1 = Ground
Pin 2 = Negative
Pin 3 = Positive

Special note:

Line termination:

When longer runs of cable are used, you may need to use a terminator on the last unit to avoid erratic behaviour.

Using a cable terminator will decrease the possibilities of erratic behaviour.

(3-pin - Order ref: CABL90, 5-pin - Order ref: CABL89)

Termination reduces signal transmission problems and interference. It is always advisable to connect a DMX terminal, (resistance 120 Ohm 1/4 W) between pin 2 (DMX-) and pin 3 (DMX+) of the last fixture.

5-pin XLR DMX connectors:

Some manufactures use 5-pin XLR connectors for data transmission in place of 3-pin. 5-pin XLR fixtures may be implemented in a 3-pin XLR DMX line. When inserting standard 5-pin XLR connectors in to a 3-pin line a cable adaptor must be used. The diagram below details the correct cable conversion.

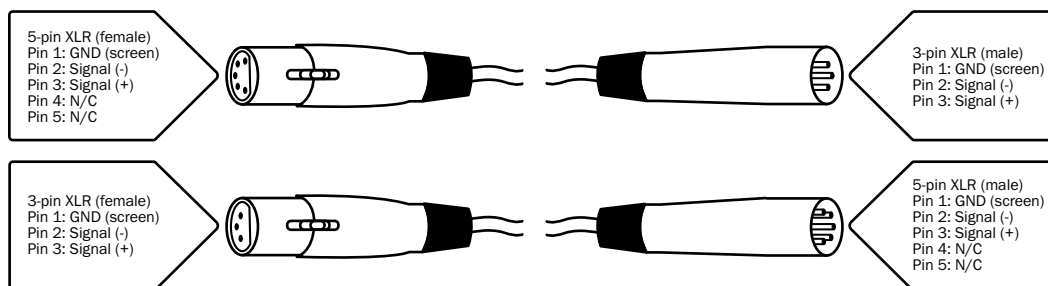



Correct Disposal of this Product (Waste Electrical & Electronic Equipment)

**(Applicable in the European Union and other European countries
with separate collection systems)**

This marking shown on the product or its literature, indicates that it should not be disposed of with other household wastes at the end of its working life. To prevent possible harm to the environment or human health from uncontrolled waste disposal, please separate this from other types of wastes and recycle it responsibly to promote the sustainable reuse of material resources.

Household users should contact either the retailer where they purchased this product, or their local government office, for details of where and how they can take this item for environmentally safe recycling.

Business users should contact their supplier and check the terms and conditions of the purchase contract. This product should not be mixed with other commercial wastes for disposal.



EQUINOX