

# **EQUINOX**

## **DJ Booth White LED Starcloth MKII**

User Manual

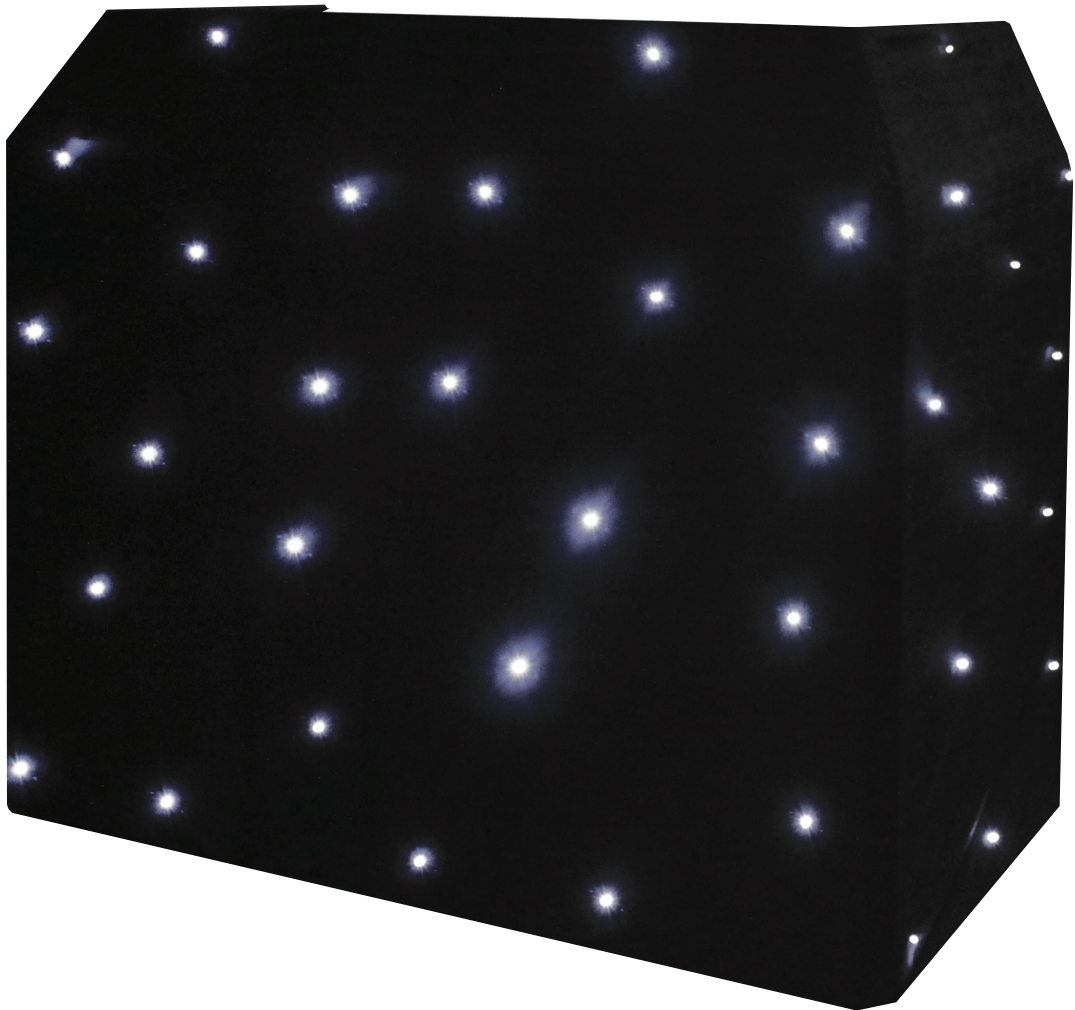

Order code: EQLED12B

### WARNING

## FOR YOUR OWN SAFETY, PLEASE READ THIS USER MANUAL CAREFULLY BEFORE YOUR INITIAL START-UP!

- Before your initial start-up, please make sure that there is no damage caused during transportation.
- Should there be any damage, consult your dealer and do not use the equipment.
- To maintain the equipment in good working condition and to ensure safe operation, it is necessary for the user to follow the safety instructions and warning notes written in this manual.
- Please note that damages caused by user modifications to this equipment are not subject to warranty.



### IMPORTANT:

The manufacturer will not accept liability for any resulting damages caused by the non-observance of this manual or any unauthorised modification to the equipment.

- Never let the power cable come into contact with other cables. Handle the power cable and all mains voltage connections with particular caution!
- Never remove warning or informative labels from the unit.
- Do not open the equipment and do not modify the unit.
- Do not connect this equipment to a dimmer pack.
- Do not switch the equipment on and off in short intervals, as this will reduce the system's life.
- Only use the equipment indoors.
- Do not expose to flammable sources, liquids or gases.
- Always disconnect the power from the mains when equipment is not in use or before cleaning! Only handle the power-cable by the plug. Never pull out the plug by pulling the power-cable.
- Make sure that the available mains supply voltage is between 100~250V AC, 50/60Hz.
- Make sure that the power cable is never crimped or damaged. Check the equipment and the power cable periodically.
- If the equipment is dropped or damaged, disconnect the mains power supply immediately and have a qualified engineer inspect the equipment before operating again.
- If the equipment has been exposed to drastic temperature fluctuation (e.g. after transportation), do not connect power or switch it on immediately. The arising condensation might damage the equipment. Leave the equipment switched off until it has reached room temperature.
- If your product fails to function correctly, stop use immediately. Pack the unit securely (preferably in the original packing material), and return it to your Pro Light dealer for service.
- Only use fuses of same type and rating.
- Repairs, servicing and power connection must only be carried out by a qualified technician. THIS UNIT CONTAINS NO USER SERVICEABLE PARTS.
- This lighting fixture is for professional use only - it is not designed for or suitable for household use. The product must be installed by a qualified technician in accordance with local territory regulations. The safety of the installation is the responsibility of the installer. The fixture presents risks of severe injury or death due to fire hazards, electric shock and falls.
- Warning! Risk Group 2 LED product according to EN 62471. Do not view the light output with optical instruments or any device that may concentrate the beam.
- WARRANTY: One year from date of purchase.

### OPERATING DETERMINATIONS

If this equipment is operated in any other way, than those described in this manual, the product may suffer damage and the warranty becomes void. Incorrect operation may lead to danger e.g: short-circuit, burns and electric shocks etc.

Do not endanger your own safety and the safety of others!

Incorrect installation or use can cause serious damage to people and/or property.

### DJ Booth White LED Starcloth MKII

Upgrade your Equinox DJ Booth with this black starcloth featuring 72 x 5mm LEDs. The Starcloth is supplied complete with a comprehensive controller featuring Auto, Sound Active and DMX control options. Additionally you can create a white starcloth effect when combining the white lycra supplied with the EQLED12P and this black starcloth.

**Cloth:**

- 72 x 5mm white LEDs
- Fast fixx™ velcro tabs
- Low reflection, fire retardant material
- Includes an advanced DMX controller
- Carry bag included

**Controller:**

- DMX channels: 5
- Sound active, auto run and auto fade modes
- IEC power input
- 3-Pin XLR input/output
- 6-Pin XLR output to starcloth

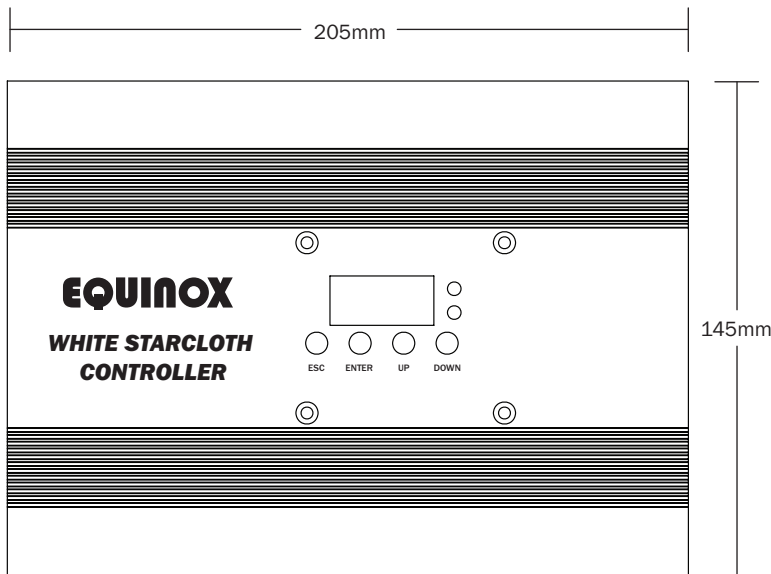
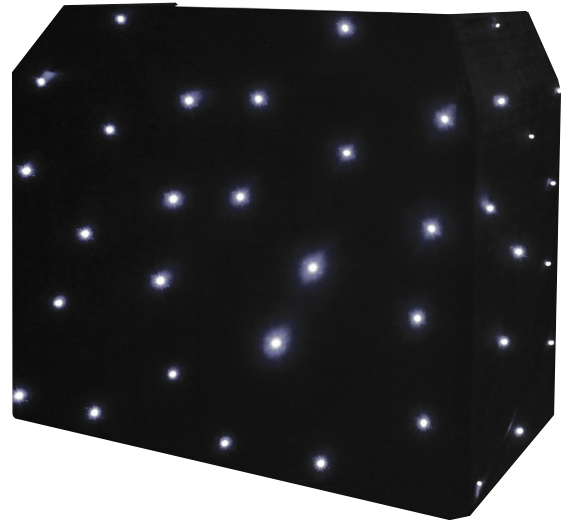

Specifications	Controller
Power supply	100~240V, 50/60Hz
Fuse	T1A 250V
Dimensions	55 x 205 x 145mm

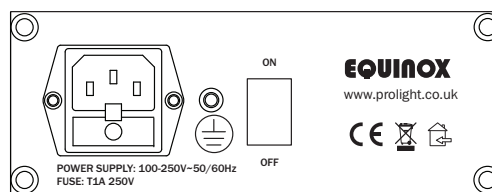
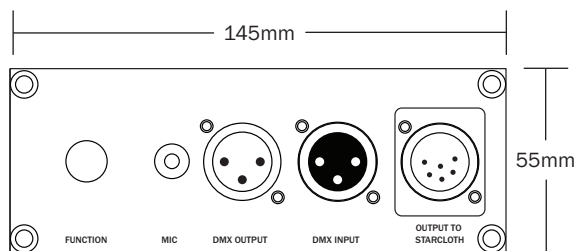

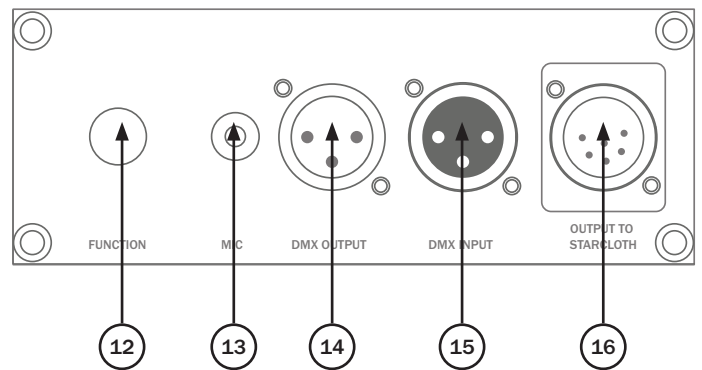
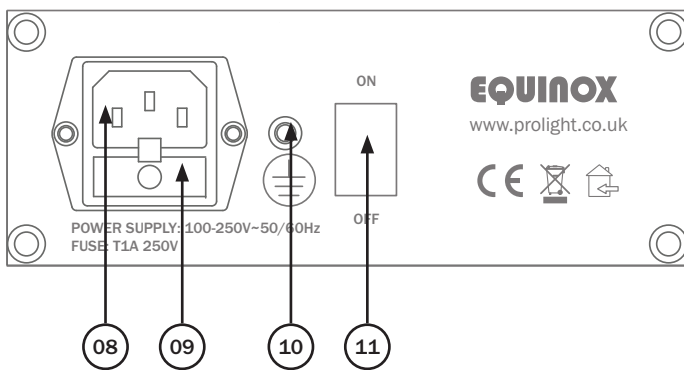
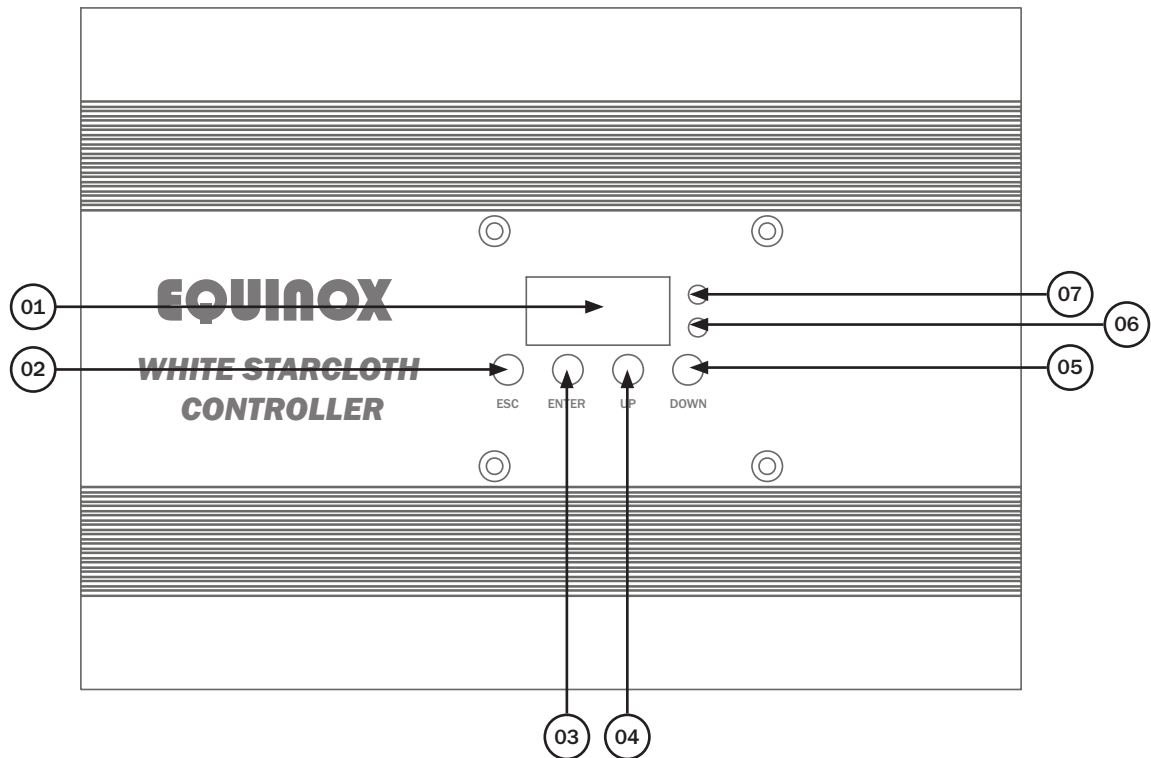

- |                       |                      |                                       |
|-----------------------|----------------------|---------------------------------------|
| 01 - LED display      | 07 - Power indicator | 13 - Microphone                       |
| 02 - Esc button       | 08 - IEC power input | 14 - 3-Pin DMX output                 |
| 03 - Enter button     | 09 - Fuse T1A 250V   | 15 - 3-Pin DMX input                  |
| 04 - Up button        | 10 - Earth point     | 16 - 6-Pin XLR<br>output to starcloth |
| 05 - Down button      | 11 - On/off switch   |                                       |
| 06 - Signal indicator | 12 - Function knob*  |                                       |
- \* \* Rotate to scroll through menu. Press to enter or press and hold to exit.

In the box:  
**1 x starcloth,**  
**1 x power cable,**  
**1 x controller &**  
**1 x user manual**

### Fitting instructions:

This cloth is designed to be fitted to the Equinox DJ Booth.

Fit the cloth from one upper corner first by hanging the sewn in pockets onto the booth.

Carefully unfold the cloth and attach the opposite corner, again by the sewn in pocket.

Once attached, the cloth must be tensioned by the integral velcro straps.

### Auto mode

To access the auto mode, press the “UP/DOWN” buttons on the front of the unit to show “Auto” on the LED display. Now press the “ENTER” button and use the “UP” and “DOWN” buttons to set the auto mode you require. Press the “ENTER” button to confirm the setting. Now use the “UP” and “DOWN” buttons to set the the speed required. Press the “ENTER” button to confirm the setting.

To exit out of any of the above options, press the “ESC” button.

### Fade mode

To access the fade mode, press the “UP/DOWN” buttons on the front of the unit to show “FADE” on the LED display. Now press the “ENTER” button and use the “UP” and “DOWN” buttons to set the the speed required. Press the “ENTER” button to confirm the setting.

To exit out of any of the above options, press the “ESC” button.

### Sound active mode

To access the sound active mode, press the “UP/DOWN” buttons on the front of the unit to show “Sound” on the LED display. Now press the “ENTER” button and use the “UP” and “DOWN” buttons to set the sound program you require. Press the “ENTER” button to confirm the setting. Now use the “UP” and “DOWN” buttons to set the the sound sensitivity (00: lowest, 31: highest).

Press the “ENTER” button to confirm the setting.

To exit out of any of the above options, press the “ESC” button.

### Pattern mode:

To access pattern mode, press the “UP/DOWN” buttons on the front of the unit to show “PATTERN” on the LED display. Now press the “ENTER” button and use the “UP” and “DOWN” buttons to set the brightness of LED string 1. Press the “ENTER” button to confirm the setting. Repeat this step for LED string 2 - 4. Press the “ENTER” button to confirm the setting. Now use the “UP” and “DOWN” buttons to set the the flash speed required. Press the “ENTER” button to confirm the setting.

To exit out of any of the above options, press the “ESC” button.

### Slave mode:

To access the slave mode, press the “UP/DOWN” buttons on the front of the unit to show “SLAVE” on the LED display. The unit is now in slave mode. Press the “ENTER” button to confirm the setting.

To exit out of any of the above options, press the “ESC” button.

### DMX address:

To change the DMX address, press the “UP/DOWN” buttons on the front of the unit to show “Addr” on the LED display. Now press the “ENTER” button and use the “UP” and “DOWN” buttons to set the address you require. Press the “ENTER” button to confirm the setting. This is also the mode that needs to be used when controlling the starcloth via DMX.

To exit out of any of the above options, press the “ESC” button.

### Software version:

To view the software version of the controller use the “**UP/DOWN**” buttons on the front of the unit to show “**VER**” on the LED display. Now press the “**ENTER**” button and the version will be displayed in the format “**V---**”.

To exit out of any of the above options, press the “**ESC**” button.

### Static mode:

To access the static mode, press the “**UP/DOWN**” buttons on the front of the unit to show “**STAT**” on the LED display. Now press the “**ENTER**” button and use the “**UP**” and “**DOWN**” buttons to set the static mode you require between “**S000 - S015**”.

S000	Blackout	S008	LED group 2 & 3 on
S001	LED group 1 on	S009	LED group 2 & 4 on
S002	LED group 2 on	S010	LED group 3 & 4 on
S003	LED group 3 on	S011	LED group 1, 2 & 3 on
S004	LED group 4 on	S012	LED group 1, 2 & 4 on
S005	LED group 1 & 2 on	S013	LED group 1, 3 & 4 on
S006	LED group 1 & 3 on	S014	LED group 2, 3 & 4 on
S007	LED group 1 & 4 on	S015	All LEDs on

Press the “**ENTER**” button to confirm the setting.

To exit out of any of the above options, press the “**ESC**” button.

### 5 channel mode:

Channel	Value	Function
1	0-20	LED group 1 blackout
	21-230	LED group 1 flash speed
	231-255	LED group 1 full on
2	0-20	LED group 2 blackout
	21-230	LED group 2 flash speed
	231-255	LED group 2 full on
3	0-20	LED group 3 blackout
	21-230	LED group 3 flash speed
	231-255	LED group 3 full on
4	0-20	LED group 4 blackout
	21-230	LED group 4 flash speed
	231-255	LED group 4 full on
5	0-100	All channels flash at speed set above
	101-255	All channels full on

### Setting the DMX address:

The DMX mode enables the use of a universal DMX controller. Each fixture requires a “start address” from 1- 511. A fixture requiring one or more channels for control begins to read the data on the channel indicated by the start address. For example, a fixture that occupies or uses 7 channels of DMX and was addressed to start on DMX channel 100, would read data from channels: 100,101,102,103,104,105 and 106. Choose a start address so that the channels used do not overlap. E.g. the next unit in the chain starts at 107.

### DMX 512:

DMX (Digital Multiplex) is a universal protocol used as a form of communication between intelligent fixtures and controllers. A DMX controller sends DMX data instructions from the controller to the fixture. DMX data is sent as serial data that travels from fixture to fixture via the DATA “IN” and DATA “OUT” XLR terminals located on all DMX fixtures (most controllers only have a data “out” terminal).

### DMX linking:

DMX is a language allowing all makes and models of different manufactures to be linked together and operate from a single controller, as long as all fixtures and the controller are DMX compliant. To ensure proper DMX data transmission, when using several DMX fixtures try to use the shortest cable path possible. The order in which fixtures are connected in a DMX line does not influence the DMX addressing. For example; a fixture assigned to a DMX address of 1 may be placed anywhere in a DMX line, at the beginning, at the end, or anywhere in the middle. When a fixture is assigned a DMX address of 1, the DMX controller knows to send DATA assigned to address 1 to that unit, no matter where it is located in the DMX chain.

### DATA cable (DMX cable) requirements (for DMX operation):

This fixture can be controlled via DMX-512 protocol. The DMX address is set on the back of the unit. Your unit and your DMX controller require a standard 3-pin XLR connector for data input/output, see image below.



Further DMX cables can be purchased from all good sound and lighting suppliers or Pro Light Concepts dealers.

Please quote:

**CABL10 – 2m**

**CABL11 – 5m**

**CABL12 – 10m**

**Note: DMX cable must be daisy chained and cannot be split.**

**Notice:**

Be sure to follow the diagrams below when making your own cables. Do not connect the cables shield conductor to the ground lug or allow the shield conductor to come in contact with the XLRs outer casing. Grounding the shield could cause a short circuit and erratic behaviour.

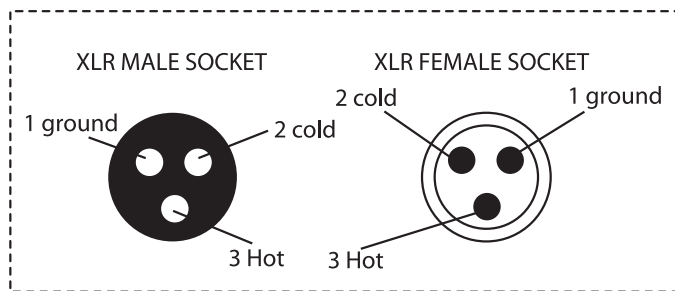
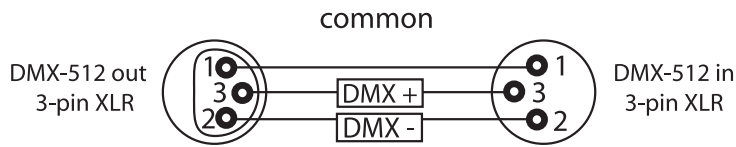

XLR Pin Configuration
Pin 1 = Ground
Pin 2 = Negative
Pin 3 = Postive

**Special note:**

**Line termination:**

When longer runs of cable are used, you may need to use a terminator on the last unit to avoid erratic behaviour.

**Using a cable terminator will decrease the possibilities of erratic behaviour.**

**(3-pin - Order code: CABL90, 5-pin - Order code: CABL89)**

Termination reduces signal transmission problems and interference. It is always advisable to connect a DMX terminal, (resistance 120 Ohm 1/4 W) between pin 2 (DMX-) and pin 3 (DMX+) of the last fixture.

**5-pin XLR DMX connectors:**

Some manufactures use 5-pin XLR connectors for data transmission in place of 3-pin. 5-pin XLR fixtures may be implemented in a 3-pin XLR DMX line. When inserting standard 5-pin XLR connectors in to a 3-pin line a cable adaptor must be used. The diagram below details the correct cable conversion.

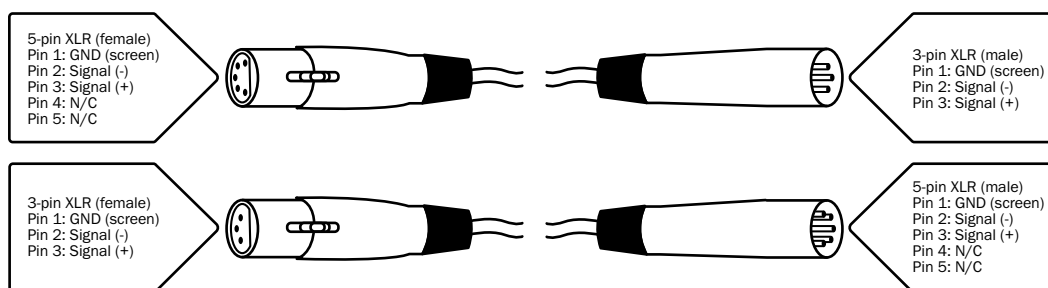



Please contact your local retailer to purchase these accessories.

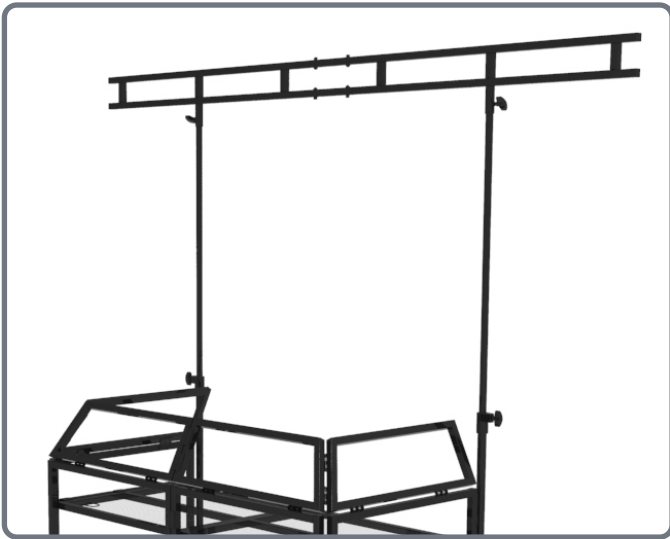

Optional Overhead kit - This allows the user to create a full light show without the need to have separate lighting stands

Order ref: EQLED12R

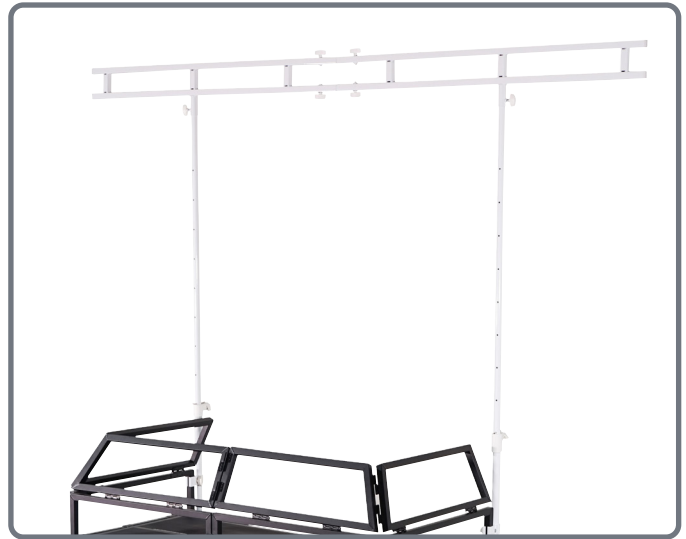

Optional White Overhead kit - This allows the user to create a full light show without the need to have separate lighting stands

Order ref: EQLED12RA



Lightweight DJ Booth MKII

Order ref: EQLED12P



Optional White Lycra available to purchase

should you need one in the future

Order ref: EQLED12C



You can also create a white starcloth effect by covering the optional black starcloth with the supplied white lycra

Optional accessories	Order code
Overhead kit	EQLED12E
Black starcloth with white LEDs	EQLED12B
Black lycra	EQLED12A
Replacement white lycra	EQLED12C
Lightweight DJ Booth MKII	EQLED12P



Optional Black Lycra

Order ref: EQLED12A



### ***Correct Disposal of this Product (Waste Electrical & Electronic Equipment)***

**(Applicable in the European Union and other European countries  
with separate collection systems)**

This marking shown on the product or its literature, indicates that it should not be disposed of with other household wastes at the end of its working life. To prevent possible harm to the environment or human health from uncontrolled waste disposal, please separate this from other types of wastes and recycle it responsibly to promote the sustainable reuse of material resources.

Household users should contact either the retailer where they purchased this product, or their local government office, for details of where and how they can take this item for environmentally safe recycling.

Business users should contact their supplier and check the terms and conditions of the purchase contract. This product should not be mixed with other commercial wastes for disposal.





**EQUINOX**