



# Product Data Sheet

**Product Type** XLR Plug

**Product Model** SCHF3-B

**Customer Name** \_\_\_\_\_

<b>Manufacturer</b>	<b>Prepared</b>	<b>Checked</b>	<b>Approved</b>

<b>Customer</b>	<b>Received</b>	<b>Checked</b>	<b>Confirmed</b>

## Product Data Sheet

<b>Product Type</b>	<b>XLR Plug</b>	
<b>Product Model</b>	<b>SCHF3-B</b>	

### Product Features

- 3-core XLR female plug with black plated stainless steel housing and gold plated contacts
- Hard, durable, long lifetime and high reliability.
- Brand new appearance design, smoother operation
- New grounding which provides good total contact between chassis and cable connectors
- Exquisite groove design on the boot for colored ring for coding and identification
- Resistant to drop and pressure which can still operate stably under harsh conditions
- The boot is equipped with polyurethane sealing sleeve to prevent the cable from being affected by bending pressure to the greatest extent

## Product Data Sheet

### Product Parameters

Item	Specification
Connection type	XLR
Gender	Female

### Electrical Parameters

Item	Specification
Capacitance between contacts	$\leq 4$ pF
Contact resistance	$\leq 3$ m $\Omega$
Dielectric strength	1.5 kV DC
Insulation resistance	$> 10$ G $\Omega$ (initial)
Rated current per contact	16 A
Rated voltage	$< 50$ V

## Product Data Sheet

### Mechanical Parameters

Item	Specification
Cable OD	3.5 - 8.5 mm
Insertion force	≤ 20 N
Withdrawal force	≤ 20 N
Service life	> 1000 mating cycles
Cable size	Max. 2.5 mm <sup>2</sup> Max. 14 AWG
Locking device	Latch lock

## Product Data Sheet

### Material and Environmental Parameters

Item	Specification
Boot	PA, TPE
Contacts	Cu alloy
Contact plating	Au
Insert	PA
Housing	Stainless steel
Housing plating	Black plating
Strain relief	POM
Flame-retardant grade	UL 94 HB
Protection class	IP40
Temperature range	-30°C ~ +80°C

### Standards and Certifications

Standards	IEC 61076-2-103
Solderability	Complies with IEC 68-2-20

## Product Data Sheet

### Product Drawing

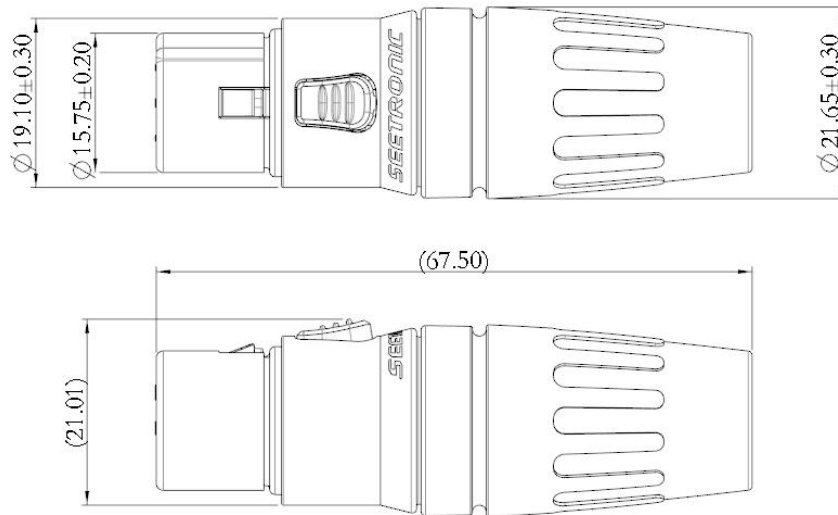

Unit: mm

### Packaging Method

1 pc per bag (include 1 pc each of inner core, housing, cable clamp, boot)  
80 pcs per inner carton, 5 inner cartons per master carton (400 pcs per master carton)

### Accessory

- |  |  |
|--|--|
| <input checked="" type="checkbox"/> No accessories | <input type="checkbox"/> Back fastener plate |
| <input type="checkbox"/> Screws and Nuts           | <input type="checkbox"/> Other               |

## Product Data Sheet

### Assembly Instructions

(1) Put the cable through the boot

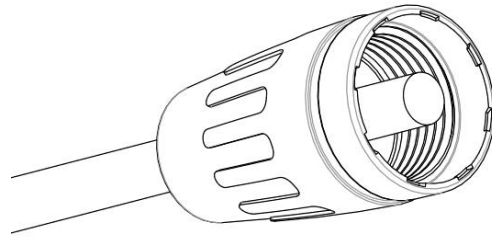

(2) Strip the cable in the size as shown

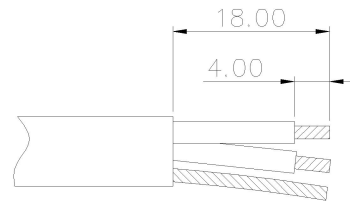

(3) Insert the conductor of the cable into the terminal of the inner core and solder

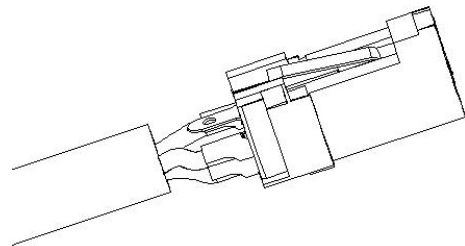

(4) Snap the clamp into the soldered cable

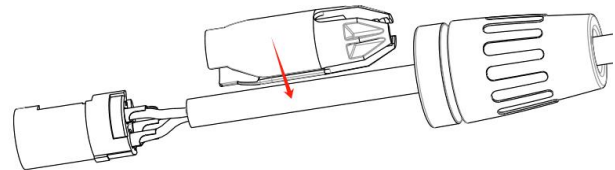

(5) Insert cable into the clamp and clip into the inner core bayonet

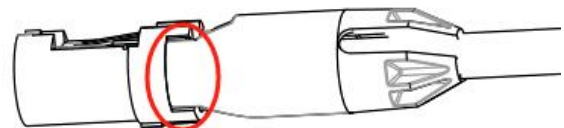

## Product Data Sheet

- (6) Push the inner core component and clamp into the housing. The two protruding ribs of the inner core component should correspond to the two grooves inside the housing

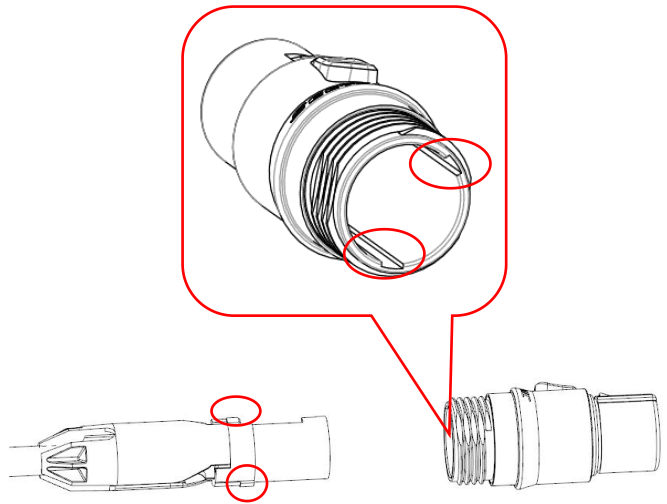

- (7) After assembly of the clamp, inner core component and housing, tighten the boot in a clockwise direction

