

# PIXXEM-E

## 128/255/512

Ethernet to DMX Stand-Alone interface

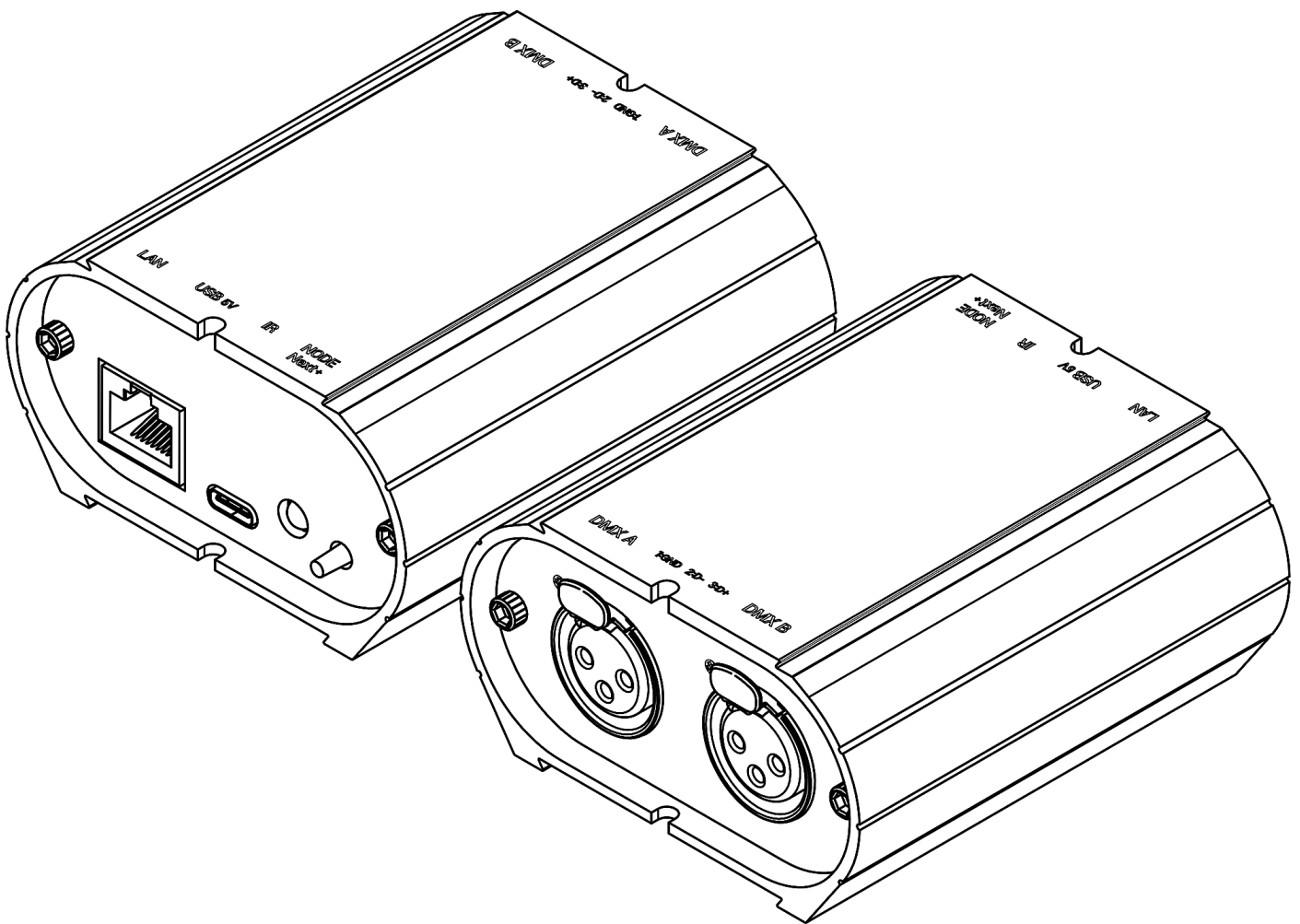

Datasheet &  
Quickstart Guide

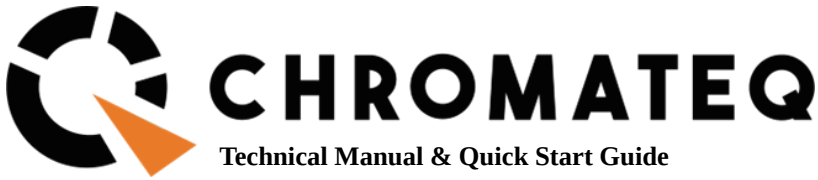

Congratulations on your purchase of a CHROMATEQ controller.

Please read this manual carefully and thoroughly before using the PIXXEM-E Chromateq.

The information presented here provides a useful introduction to the wide range of features, settings and functions available in this compact and versatile PIXXEM-E

The PIXXEM-E Technical Manual is written in English and French.  
(Le manuel technique du PIXXEM-E est rédigé en anglais et en français.)

All products and software are developed and designed in France.

CHROMATEQ SARL

191 Allée de Lauzard 34980 St Gély du Fesc FRANCE VAT: FR18521458034 Siret: 52145803400027 Web & E-mail:  
www.chromateq.com Phone: +33 952210755 / +86 13422062209 Whatsapp: +8613422062209 Wechat: Chromateq QQ:  
2908265661

Twitter: <https://twitter.com/Chromateq>

Facebook: <https://www.facebook.com/ChromateqCompany/>

YouTube: <https://www.youtube.com/c/chromateq>

---

### Copyright Information and Disclaimer

Copyright © 2021 - CHROMATEQ. All rights reserved.

No part of this publication may be reproduced, distributed or transmitted in any form or by any means whatsoever, including photocopying, recording or other electronic or mechanical methods, without the prior written permission of the publisher, except in the case of brief quotations in criticisms and certain other non-commercial uses permitted by copyright law.

For any request for authorization, write to the publisher at the address above.

### Trademark credits

Microsoft and Windows are U.S. registered trademarks of Microsoft Corporations. Art-Net™ - Designed by and Copyright Artistic License Holdings Ltd. All other products mentioned herein may be trademarks of their respective ® companies.

### Package Contents

- 1x PIXXEM-E
- 1x USB cable
- 1x Power supply 9-12V DC (Euro/US socket)
- 1x software download link and technical documentation

**Caution: Check the contents of the package and the condition of the interface after unpacking! Contact your supplier if something is missing or is damaged. Do not use the device if it appears to be damaged!**

## Table des matières

Introduction.....	4
Technical specifications.....	4
Device Features.....	4
Software options.....	5
Housing connectivity .....	6
Front Panel .....	6
Rear Panel.....	6
USB drivers installation .....	7
Multiple USB connections.....	7
Ethernet connection and configuration.....	8
DHCP / IP Static.....	8
DHCP connection.....	8
Static IP connection.....	9
Reset of the IP address.....	9
Connecting to a wifi router.....	9
Standalone mode settings .....	10
Device configuration .....	10
IN/OUT tab .....	10
"Merge DMX In / DMX Out" option.....	11
Art-Net/sACN universe range:.....	12
Options tab .....	12
Scenes selection and configuration .....	13
Triggers selection.....	14
Infrared Trigger.....	14
Triggers via Wi-light 2 app and UDP commands.....	14
Advanced trigger options. ....	15
Restore after power off.....	15
Play in priority.....	15
Save in memory option.....	16
Basic backup.....	17
Save to an internal and external micro SD card.....	17
Save Art-Net or sACN to an external SD card .....	17
Standalone use.....	18
Switch to standalone mode.....	18
External and USB power supply.....	18
How to use IR Remote.....	18
Previous Remote Control Unit (Before 2022).....	18
Functioning for Interfaces without Mode and older interfaces.....	18
Functioning for Interfaces with Modes.....	19
New Remote Control Unit (2022).....	19
Functioning for Interfaces without Mode and older interfaces.....	18

Functioning for Interfaces with Modes.....	20
Functions descriptions.....	20
IR Codes.....	21
NODE mode setup.....	22
Setup with the software.....	22
Network setup .....	22
NODE Art-Net or sACN mode.....	22
Setup with the DeviceTool.....	23
Network setup .....	23
NODE Art-Net or sACN mode.....	23
Setup with a Web Browser.....	24
UDP, Broadcast, Unicast, Multicast.....	24
Reset the default device .....	25
NODE wiring diagram.....	25
Detecting NODEs on the network .....	26
Art-Net wiring diagram.....	27
Housing dimensions.....	28
Front panel .....	28
Back panel.....	28
Tops panel.....	28
Troubleshooting .....	29

## Introduction

PIXXEM-E 128/255/512 is designed for Live projects in Art-Net or DVI with pixel mapping, LED matrices and video screens. When connected to a computer, it enables control of Art-Net universes via the computer's Ethernet network port.

### Objectives

The purpose of this technical manual is to develop the options managed by the interface in standalone mode, refer to software manuals.

## Technical specifications

Input	USB-C and RJ45 Ethernet (10Mb/s)
DMX outputs	2x512 or 1024 on 3-pin XLR (XLR 5 optional)
DMX mode	2x512, 1024 or 512 In/Out (PC + standalone)
Internal memory capacity	100 ~ 1024 steps
CPU	32-bit processor
Power supply	5V, 0.3A via USB-C
Index of protection	IP22
Dimensions (mm)	H: 45 (1.77 in) / L: 90 (3.54 in) / I: 80 (3.15 in)
Net weight	0.19 Kgs (0.42 lbs)
Gross weight	0.31 Kgs (0.68 lbs)
Power / Consumption	1.5 W
High voltage protection	Yes, fuses and diodes
Case	Anthracite Grey, Brushed Aluminium
Environment of use	Interior
Storage	Store dry
Temperature of use	- 40 to +85 C°
Certifications	CE, RoHS
International guarantee	Yes, 5 years
Compatibility of systems	Windows (7 and higher), MAC OS X (10.13 and higher) and Linux (64 Bits, Debian, Redhat, Archlinux, Raspberry Pi)

## Device Features

DMX input	PC , DMX recording, DMX trigger
Standalone mode	2x512 (splitter), 1024, 512 outputs, 16-bit DMX channels
Art-Net, sACN	Yes, PC
NODE Art-Net sACN	Art-Net and sACN to DMX decoder, 2x512 channels (2 DMX universe)

Supported modes	UDP, Broadcast, Unicast, Multicast, fixed IP, DHCP
Infrared receiver	Infrared remote control (available as an option)
Infrared options	10 scene selections, speed, intensity Main dimension and next scene
Communication UDP	Ethernet protocol (UDP) with a list of possible commands for CLUB-E
Compatibility	8 and 16-bit DMX devices
RDM (Remote Device Management, bi-directional DMX communication)	Yes, with Pro DMX 2 only
Wi-Light 2	Yes
WEB control with Wi-Light 2	No

## Software options

	DMX Line	Art-NET / sACN	DVI supported resolution
Pixel mapping software	2x512 channels	128x512 channels or 255x512 channels or 512x512 channels	1280x720 / 921600 1280x1024 / 1310720
			Option mode
Software Player	2x512 channels	64x512 channels	standalone mode, Live Board mode
Software Pro Software	2x512 channels	64x512 channels	Normal mode, 24h audio and video timeline loop
Studio DMX 3D viewer	Full mode		
Art-Net sent from the PC	2 Universe (DMX + Artnet)		
Wi-Light 2 App	Controls Player, Pro and Pixxem software over a local WiFi network		
Free software updates	Yes		

# Housing connectivity

## Front Panel

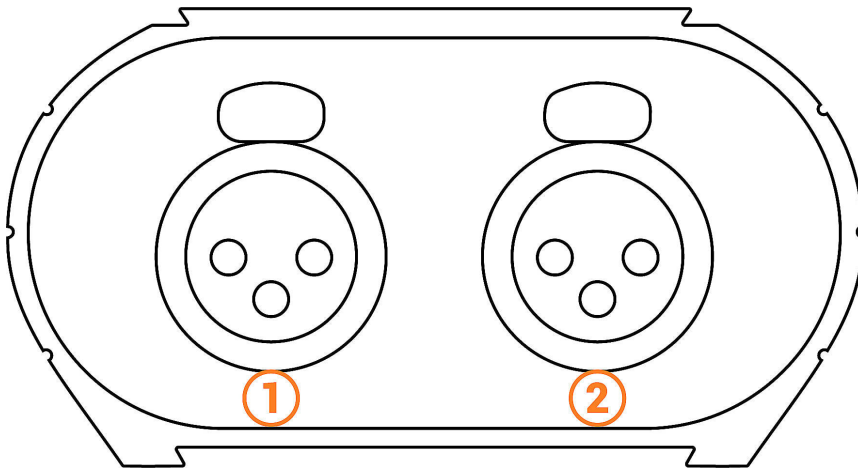

- 1 - Output DMX A,
- 2 - Input / Output DMX B

XLR Connector 3 pins

- 1: Ground
- 2: Data -
- 3: Data +

## Rear Panel

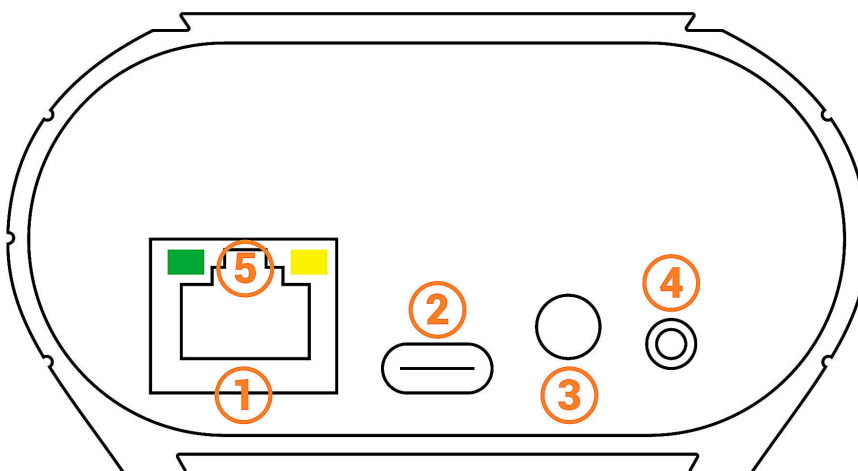

- 1 - RJ45, Network (LAN) connection
- 2 - USB-C, power connector (5V. DC, 0.3A)
- 3 - Infra-red receiver LED, optional
- 4 - Modes selector (5 s.) Art-Net or sACN
- 5 - LEDs signals : green (G) et Yellow (Y)

### LED signal correspondence

G on + Y off	No signals
G fast blink + Y off	USB signal
G on + Y fast blink	Ethernet signal
G slow blink + Y off	Stand Alone DMX
G on + Y slow blink x1	NODE Mode converter Art-Net to DMX
G on + Y slow blink x2	NODE Mode converter sACN to DMX

# USB drivers installation

Install USB drivers to communicate with the device and change settings.  
Installation of USB drivers is required only for Windows at the end of installation.  
Drivers for Mac and Linux systems are installed automatically.

## USB drivers verification :

In the Windows Device Manager. Check that the device icon is visible in "USB Bus Controllers".

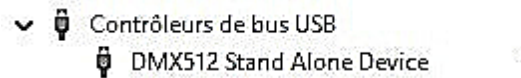

If drivers are not installed, the Windows Device Manager lists a device with a yellow warning.

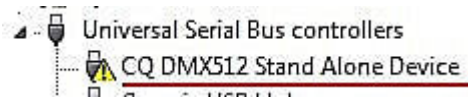

On Mac OS, simply check the USB device tree to view "DMX 512 Stand Alone Device". On Linux, use the "lsusb" command to view "DMX 512 Stand Alone Device" as a list.

## After control software installation and USB drivers

- Connect the device with the USB cable.
- Start the DEVICETOOL and select "Open USB Device" to change the settings.
- Start the software and menu "Tools", then "Options" to change the settings in the "Device" page.

All connected and detected devices are listed.

# Multiple USB connections

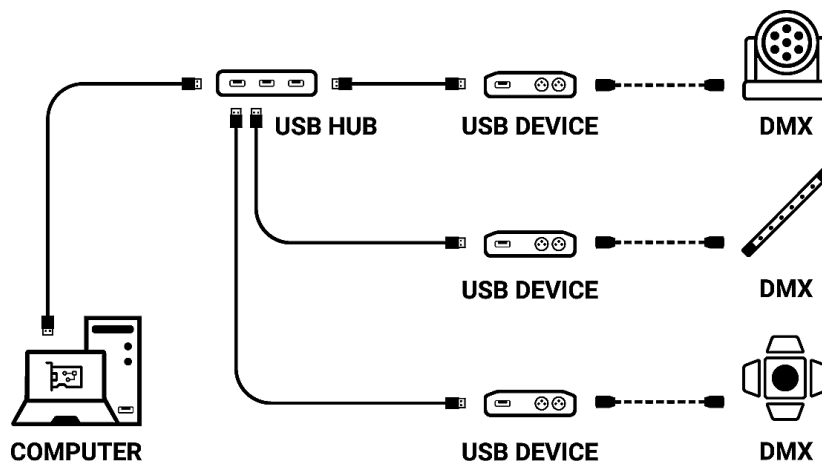



# Ethernet connection and configuration

Establish Ethernet communication with the device to change its settings in the software options window or via the DEVICETOOL.

It can be done in several ways: Live, via an IP Switch or a Wifi router. The device is in DHCP mode by default.

## Initial steps required

- Connect the device to the LAN or computer via an RJ45 Ethernet cable.
- Power the device via USB cable (5V DC, 0.3A).
- Connect the computer to the same network (LAN) or interface via an RJ45 Ethernet cable.

## DHCP / IP Static

In DHCP mode, without responses from a DHCP server after a short time, the interface will use static IP mode with its default IP address and wait for the next DHCP request to use DHCP mode. It will therefore always be possible to connect directly to the computer in static IP MODE. The device is in DHCP mode by default.

## DHCP connection

DHCP mode, allows you to communicate with devices through a DHCP server that automatically assigns and manages the IP addresses of each device. The DHCP server can be of Switch IP or Router type or other.

The device is in DHCP mode by default.

It is detected by software automatically when the computer is also connected in DHCP to the same network or with a static IP address of the same range.

DHCP benefit is that the DHCP server automatically manages the IP addresses of connected devices. So it is not necessary to know exactly the IP of your device to connect to it. However, IPs are regularly modified and can make the installation less reliable.

## Setting up the DHCP connection

- After the required initial steps are completed.
- If the device is in DHCP mode (default mode).
- Also configure the computer in DHCP mode.
- Start the software or DEVICETOOL by selecting "Open Ethernet Device"

## Static IP connection

Static IP mode, allows you to communicate directly with an interface without necessarily going through another device such as IP switch or router or access point. It is also used on LANs without DHCP server.

Static IP mode also allows you to freeze a network configuration and provides better stability to installations designed with multiple devices thanks to an IP switch or routers.

The default static values of the device are:

IP address: 192.168.0.5

Subnet mask: 255.255.255.0

### Setting up the Static IP connection

- After the required initial steps are completed.
- If the device is in Static IP mode.
- Set the IP address of the computer to an identical IP address range of type 192.168.0.x. With "x" different than 5 to avoid identical IP conflicts on the network.
- Also set the subnet mask to 255.255.255.0.
- Start the software or application.

In an identical IP address range, the device will be recognized when software starts.

## Reset of the IP address

If there is a default IP address not found, use the USB connection and software settings tools to check or change the device IP address.

## Connecting to a wifi router

If the device's RJ45 port allows a wired connection to a local network, it is also possible to connect to it via WIFI via a WIFI router.

The illustration below is an example of a configuration using a third-party mini WiFi router to allow a wireless connection. Other descriptions of these routers can be "hotspot", "hub", "dongle", "bridge", "repeater", etc.

**Note:** Connect multiple devices to the WiFi router or extend the available RJ45 ports with a Switch IP.

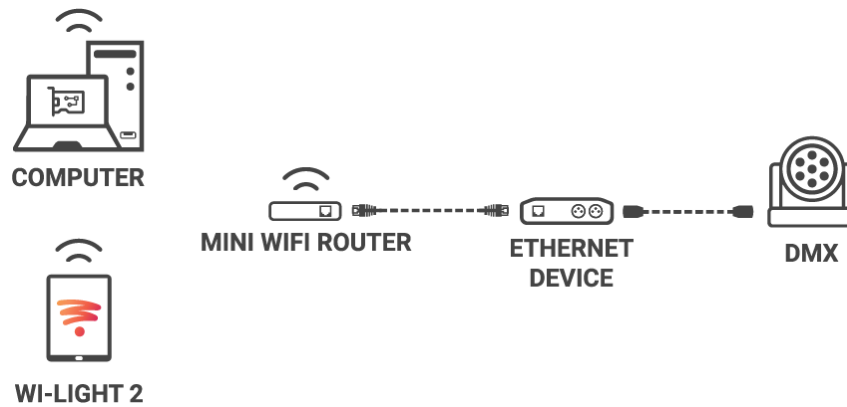

### Implementation of the WIFI network:

- Set up the WiFi router as a Hotspot to create a new access point.
- Or configure the WiFi router as “Bridge” or repeater to join an existing network.
- It is possible to configure the router in Static IP or DHCP.
- In DHP (default mode of a router) IP addresses are dynamically assigned on the network by the DHCP server.
- After configuring the router, connect the RJ45 ports and configure the device in DHCP or static IP mode.
- Once the device is connected to the router, it can be used and visible on the network.

## Standalone mode settings

In standalone mode of the control software,  configure the device according to the available options then select and configure the triggers of scenes to be written in memory.

## Device configuration

### IN/OUT tab

Select a DMX input/Output configuration of the interface from the drop-down menu

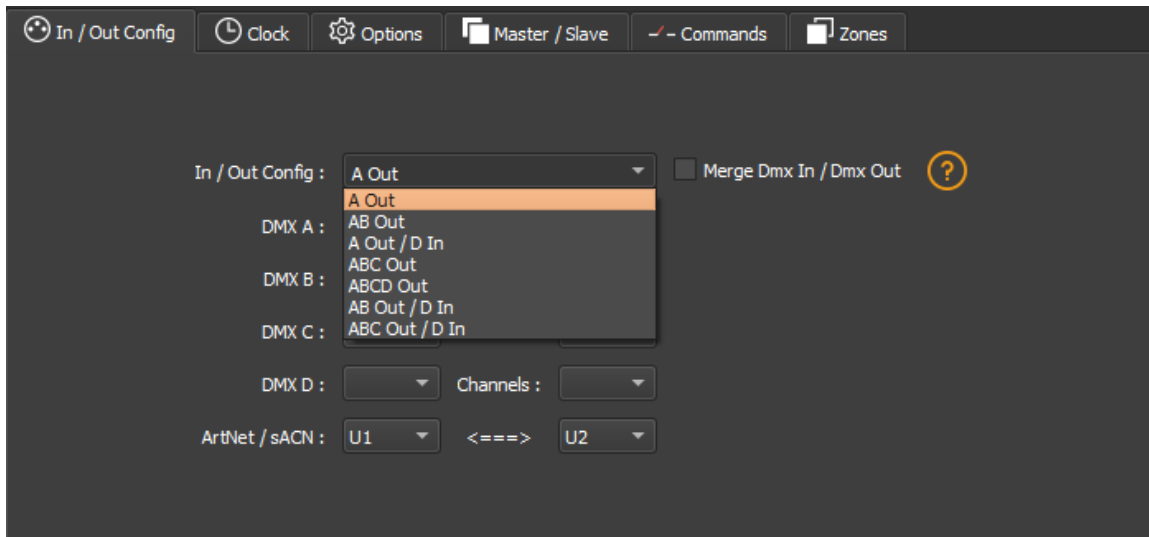

Available configurations will be displayed depending on the connected device depending on whether it has 1.2 or 4 DMX lines.

- **A OUT** - Assigns 1 output universe on the DMX line(s), for devices that have more than 1 DMX lines duplicate the universe on each.
- **AB OUT** - Assigns 1 different output universe on 2 DMX lines, for devices that have 4 DMX lines duplicates the first 2 lines on the next 2 lines.
- **A OUT/B or D IN** - Assigns 1 output universe on the first line(s) and uses the last DMX line as DMX input.
- **ABC OUT** - Assigns 1 different universe output on the first 3 DMX lines.
- **ABCD OUT** - Assigns 1 different universe output on 4 DMX lines.
- **AB OUT / D IN** - Assigns 1 different output universe on the first 2 lines and uses the last DMX line as DMX input.
- **ABC OUT / D IN** - Assigns 1 different output universe on the first 3 lines and uses the last DMX line as DMX input.

**"Merge DMX In / DMX Out" option**

**Available with interfaces with more than 2 or 4 DMX lines.**

Enable the option to re-inject line configured as an input (IN) to the line(s) configured in DMX outputs and thus merge them.

The merged DMX levels are compared and the highest is retained. We are talking about HTP (Highest Takes Priority).

Maintain manual control on some circuits with an external DMX console.

Create a multi-zone system by merging several cascading interfaces to obtain only one common DMX line.

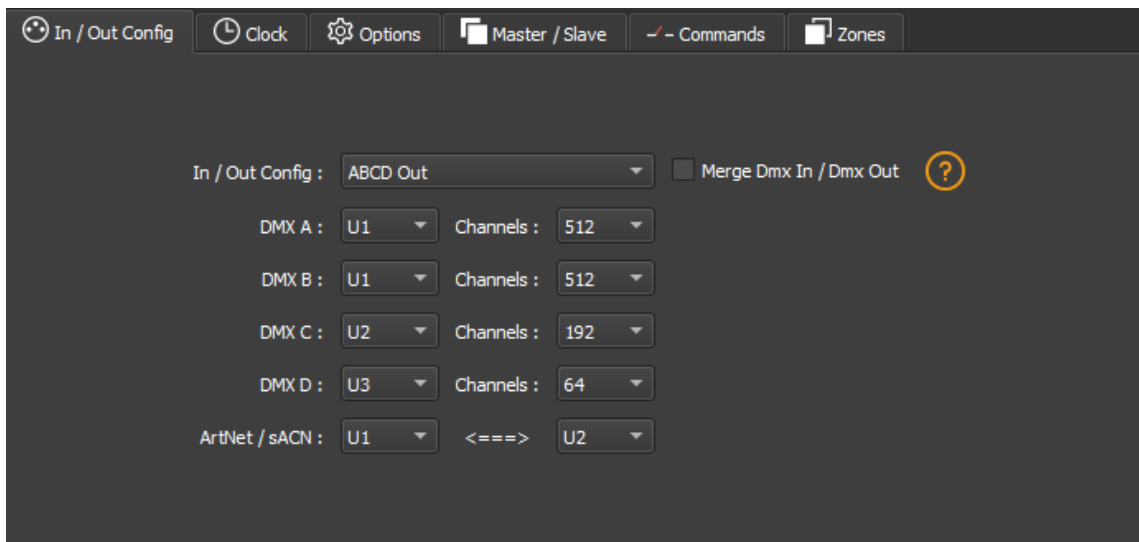

Assign any universe of the software to any DMX line assigned to output, choosing line by line (U1, U2...).

Optimize the size of shows saved in memory by reducing the number of circuits per universe depending on the channels used.

**Example:** If 150 channels are used in the show, select only the nearest higher value, here 192.

### **Art-Net/sACN universe range:**

Define the starting universe and the finish universe to write in memory on an external SD card for an Art-Net/sACN show.

Cf: "Saving Art-Net or sACN to an external SD card"

## **Options tab**

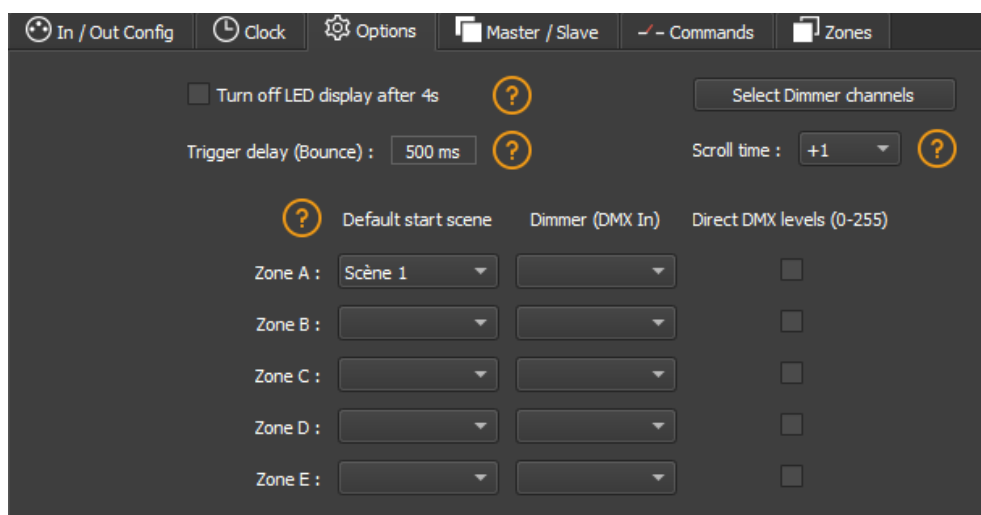

For devices with an LED display, turn it off after 4 seconds of inactivity by checking the option.

Select a default scene to play automatically after the interface is turned on (with USB or external power supply). For multi-zones devices it is possible to set a default scene for each area.

**Note:** The selected default start scene loses its priority if another scene uses the "Restore if power off" option.

Cf: "Advanced trigger options"

Configure the "Select Dimmer channels" option to select separately the Dimmer or RGBW light intensity channels that will be controlled directly by Dimmer mode, dry contacts or via the infrared remote control.

Sélectionner les circuits Dimmer

1	2	3	4	5	6	7	8	9	10	11	12	13	14	15	16	17	18	19	20	21	22	23	24	25	26	27	28	29	30	31	32
33	34	35	36	37	38	39	40	41	42	43	44	45	46	47	48	49	50	51	52	53	54	55	56	57	58	59	60	61	62	63	64
65	66	67	68	69	70	71	72	73	74	75	76	77	78	79	80	81	82	83	84	85	86	87	88	89	90	91	92	93	94	95	96
97	98	99	100	101	102	103	104	105	106	107	108	109	110	111	112	113	114	115	116	117	118	119	120	121	122	123	124	125	126	127	128
129	130	131	132	133	134	135	136	137	138	139	140	141	142	143	144	145	146	147	148	149	150	151	152	153	154	155	156	157	158	159	160
161	162	163	164	165	166	167	168	169	170	171	172	173	174	175	176	177	178	179	180	181	182	183	184	185	186	187	188	189	190	191	192
193	194	195	196	197	198	199	200	201	202	203	204	205	206	207	208	209	210	211	212	213	214	215	216	217	218	219	220	221	222	223	224
225	226	227	228	229	230	231	232	233	234	235	236	237	238	239	240	241	242	243	244	245	246	247	248	249	250	251	252	253	254	255	256
257	258	259	260	261	262	263	264	265	266	267	268	269	270	271	272	273	274	275	276	277	278	279	280	281	282	283	284	285	286	287	288
289	290	291	292	293	294	295	296	297	298	299	300	301	302	303	304	305	306	307	308	309	310	311	312	313	314	315	316	317	318	319	320
321	322	323	324	325	326	327	328	329	330	331	332	333	334	335	336	337	338	339	340	341	342	343	344	345	346	347	348	349	350	351	352
353	354	355	356	357	358	359	360	361	362	363	364	365	366	367	368	369	370	371	372	373	374	375	376	377	378	379	380	381	382	383	384
385	386	387	388	389	390	391	392	393	394	395	396	397	398	399	400	401	402	403	404	405	406	407	408	409	410	411	412	413	414	415	416
417	418	419	420	421	422	423	424	425	426	427	428	429	430	431	432	433	434	435	436	437	438	439	440	441	442	443	444	445	446	447	448
449	450	451	452	453	454	455	456	457	458	459	460	461	462	463	464	465	466	467	468	469	470	471	472	473	474	475	476	477	478	479	480
481	482	483	484	485	486	487	488	489	490	491	492	493	494	495	496	497	498	499	500	501	502	503	504	505	506	507	508	509	510	511	512

Univers

1	2	3	4
5	6	7	8
9	10	11	12
13	14	15	16
17	18	19	20
21	22	23	24
25	26	27	28
29	30	31	32

Select Dimmer channels      Select RGBW channels

✓ ✗

## Scenes selection and configuration

	Name	Duration	Properties	Triggers	Zone
1	Scène 1	00m 04s 000	00:00:000 #oo	●	A
2	Scène 2	00m 09s 960	00:00:000 #oo	●	A
3	Scène 3	00m 11s 000	00:00:000 #oo	●	A
4	Scène 4	00m 02s 000	00:00:000 #oo	●	A
5	Scène 5	00m 02s 000	00:00:000 #oo	●	A
6	Scène 6	00m 02s 000	00:00:000 #oo	●	A
7	Scène 7	00m 02s 000	00:00:000 #oo	●	A
8	Scène 8	00m 03s 000	00:00:000 #oo	●	A
9	Scène 2	00m 03s 000	00:00:000 #oo	●	B
10	Scène 3	00m 02s 400	00:00:000 #oo	●	C
11	Scène 4	00m 09s 960	00:00:000 #oo	●	D

Device Triggers Time triggers Schedule activation

RS232 ?  Restore if power off ?

?  Play in priority ?

1%

Check to select the scenes to write in memory and assign triggers from those available by your device.

## Triggers selection

In the "Triggers" tab, select and assign different types of triggers.

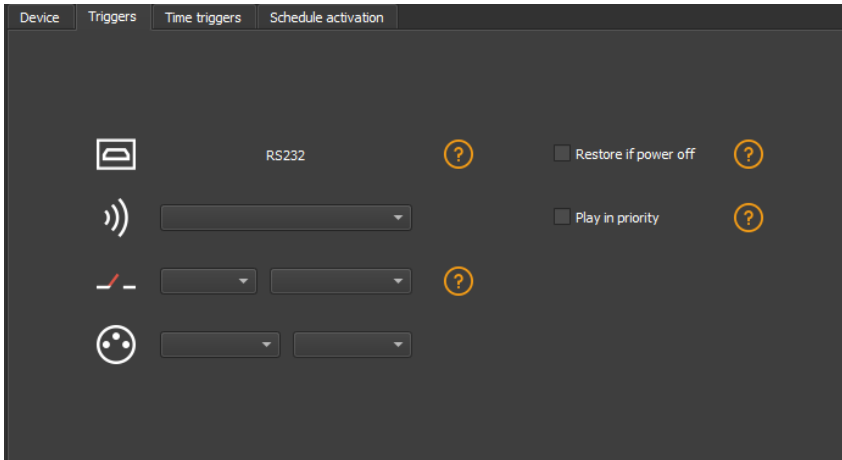

### Infrared Trigger

For devices that do not have this trigger option an Infrared kit is available containing an IR receiver and a remote control.

Cf: *"use of the remote control by infrared"*

Select a scene from the list and assign it a remote control button from the 15 available buttons.

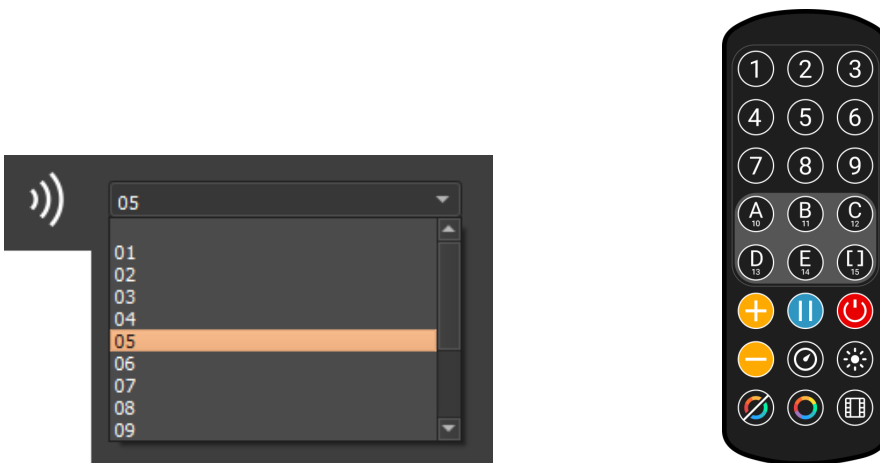

Automatically assign buttons to all scenes in the list by clicking the Infrared icon on the scene list toolbar.

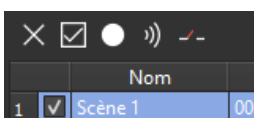

### Triggers via Wi-light 2 app and UDP commands

When connected to a local network with a WIFI access point, it is possible to trigger and control the interface with the Wi-Light 2 app for Android and iOS when it runs in standalone mode. This

local mode is also available on the internet with the Web Remote option.

Each device, interface and mobile, must be connected to the same access point in DHCP (recommended) or fixed IP mode. The application will then detect the interface and display the list of scenes and other possible controls and commands. The Web Remote control option requires you to create a user account and save your interfaces locally first. Please refer to the Wi-Light 2 manual to use this mode.

The Wi-Light 2 app uses an open protocol for developers with standard communication based on simple UDP commands.

Third-party software can establish UDP communication with the software/interface and control it using predefined JSON commands. Option only available with interfaces with an Ethernet port. (see "Communication Development Kit User Manual")

## Advanced trigger options.

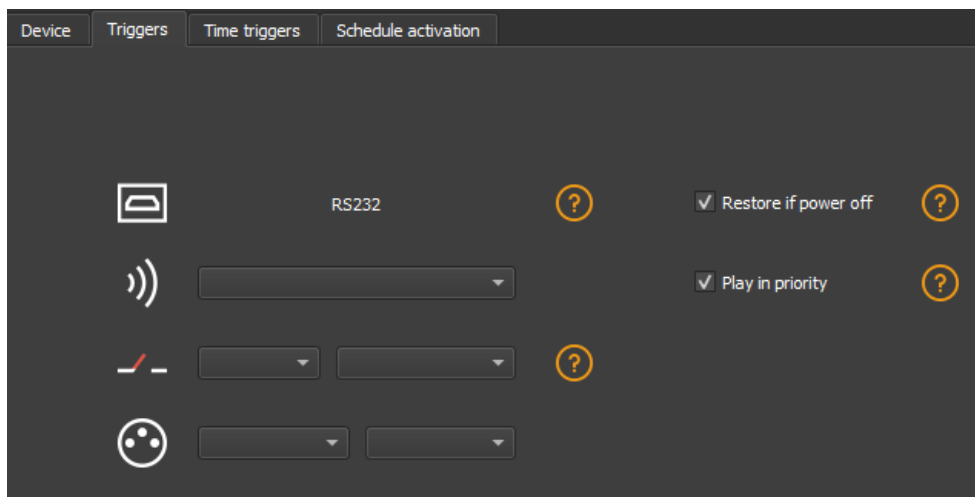

### **Restore after power off**

By checking this option in the "Triggers" tab, the selected scene takes priority on the boot scene (see "Options tab") when the power supply is restored.

If all scenes have the option checked, the last active scene is replayed.

### **Play in priority**

By checking this option in the "Triggers" tab, the selected scene plays continuously until its end, without taking into account other triggers, except for time triggers and physical buttons on the device.



# Save in memory option

Check scenes that need to be saved in memory.

	Name	Duration	Properties	Triggers	Zone
1	<input checked="" type="checkbox"/> Scene 1	00m 14s 400	00:05:000 #00		A
2	<input checked="" type="checkbox"/> Scene 3	00m 00s 480	00:03:000 #00		A
3	<input checked="" type="checkbox"/> Scene 4	00m 05s 720	00:05:000 #1		A
4	<input type="checkbox"/> Scene 5	00m 18s 000	00:07:000 #1		A
5	<input type="checkbox"/> Scene 6	00m 05s 000	00:00:000 #00		A
6	<input checked="" type="checkbox"/> Scene 6_copy_1	00m 05s 000	00:00:000 #00		A
7	<input type="checkbox"/> Scene 6_copy_2	00m 07s 000	00:00:000 #00		A
8	<input type="checkbox"/> Scene 6_copy_3	00m 07s 000	00:00:000 #00		A
9	<input type="checkbox"/> Scene 6_copy_4	00m 07s 000	00:00:000 #00		A
10	<input type="checkbox"/> Scene 6_copy_5	00m 07s 000	00:00:000 #00		A
11	<input type="checkbox"/> Scene 6_copy_6	00m 07s 000	00:00:000 #00		A
12	<input type="checkbox"/> Scene 6_copy_7	00m 07s 000	00:00:000 #00		A
13	<input type="checkbox"/> Scene 6_copy_8	00m 07s 000	00:00:000 #00		A
14	<input type="checkbox"/> Scene 6_copy_9	00m 07s 000	00:00:000 #00		A
15	<input type="checkbox"/> Scene 16	00m 03s 000	00:05:000 #3		A
16	<input type="checkbox"/> Scene 17	00m 08s 000	00:00:000 #2		A
17	<input type="checkbox"/> Scene 18	00m 03s 200	00:00:000 #40		A
18	<input type="checkbox"/> Scene 19	00m 13s 000	00:00:000 #2		A
19	<input type="checkbox"/> Scene 20	00m 04s 000	00:00:000 #2		A
20	<input type="checkbox"/> Scene 21	00m 03s 500	00:00:000 #2		A

Click on the "Write in Memory" button

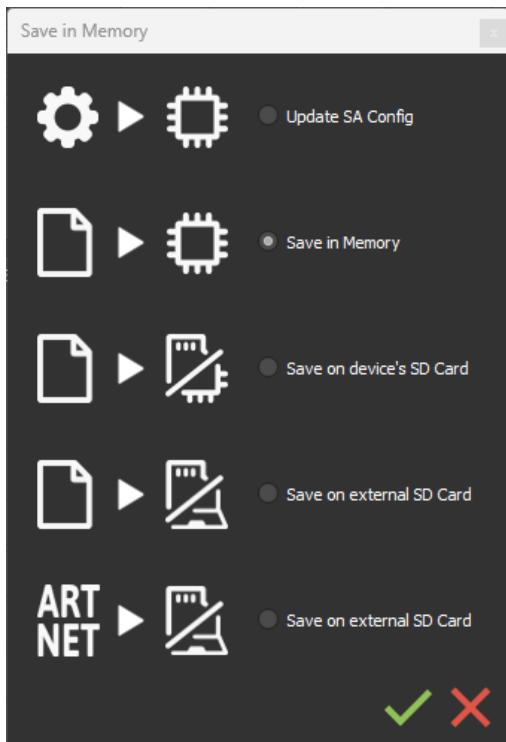

Select the desired option in the Scenes Write window.

## Basic backup

**Write standalone configuration:** Change only certain settings in the configuration of a show already written in memory. Reduces backup time.

**Write to Memory:** Default backup in the internal memory of the device.

## Save to an internal and external micro SD card

For devices with a micro SD port.

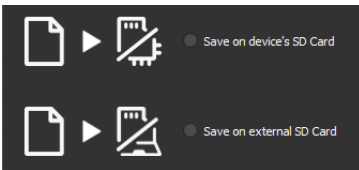

Save scenes to a micro SD card (Class 10) installed in the device's SD card reader or in the computer drive. The card must be CLASS 10, formatted in FAT or FAT 32 with a maximum capacity of 256 GB. It is recommended to use the largest allocation unit size available when formatting.

**Write to the SD card of the device:** SD card installed in the interface drive

**Write to an external SD card:** SD card connected to the computer

Note: Save to the root directory of the SD card.

## Save Art-Net or sACN to an external SD card

For devices with a micro SD port and an Ethernet port.

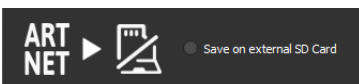

**Art-Net - Write to an external SD card:** Save up to 8 universes only on micro SD to render an Art-Net or sACN show independently.

Set the universe range in the IN/OUT config tab. Cf:

Pre-commissioning verification:

Connecting the RJ45 cable before power on.

Connection to the local network. Cf: "Ether Ethernet connection and configuration"

Configuring the device in Art-net or sACN mode via the software or DeviceTool.

**Note:** Once in Art-Net (Ar) or sACN (AC) mode, the interface is no longer visible on the local network.

In Art-Net the interface will use Broadcast to play the show on the network.

In sACN the interface will use the Multicast to play the show on the network.

# Standalone use

## Switch to standalone mode

The interface switches to standalone mode automatically after 5 seconds after power on and if no software connection is made.

## External and USB power supply

The external power supply is only used for "Autonomous" mode. But it is possible to connect a USB cable and power supply at the same time, even if this configuration is not recommended. If a USB cable is connected to the interface when running in standalone mode, the device will detect a possible connection to a computer but this will not affect the scenes that play.

## How to use IR Remote

Infrared Remote triggers work in Stand Alone and in Live mode when "Get Stand Alone Triggers" is checked in software option window, at the bottom of "Device" section.  Get Stand Alone triggers

## Previous Remote Control Unit (Before 2022)

### Functioning for Interfaces without Mode and older interfaces.

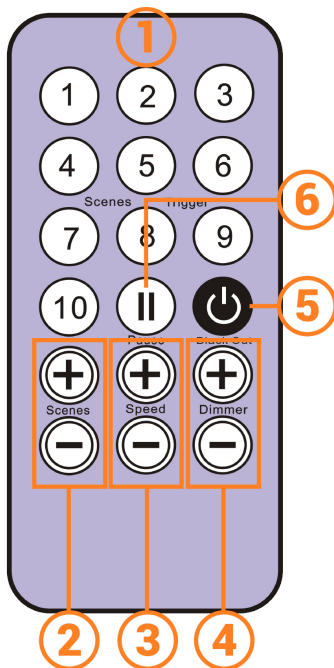

1. **Scene trigger buttons** (1 to 10) assigned via the software.
2. **Scene selector**, next or previous.
3. **Speed value**, increase & decrease
4. **Dimmer value**, increase & decrease
5. **Blackout**: Stops the current scene and plays the scene 00. All DMX levels are set to zero.
6. **Pause**: Freezes the current scene in its state

## Functioning for Interfaces with Modes

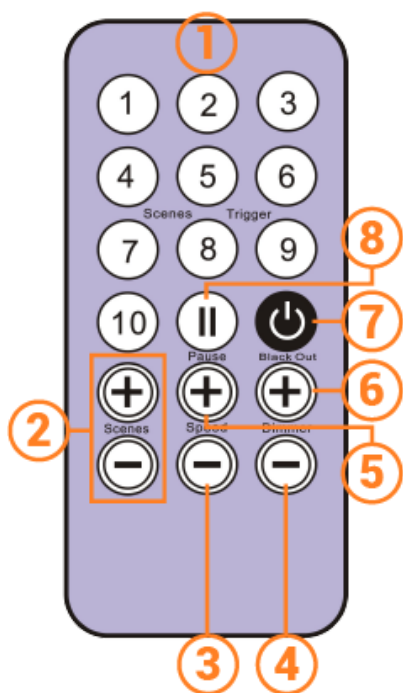

1. **Scene trigger buttons** (1 to 10) assigned via the software
2. **Increase or decrease** the value of the selected mode:  
Scene +/-, Dimmer +/-, Speed +/-, Color +/-.
3. **Color mode**
4. **Scene mode**
5. **Dimmer mode**
6. **Speed mode**
7. **Blackout:** Stops the current scene and plays the scene 00.  
All DMX levels are set to zero.
8. **Pause:** Freezes the current scene in its state.

## New Remote Control Unit (2022)

### Functioning for Interfaces without Mode and older interfaces.



1. **Scene trigger buttons** (1 to 10) assigned via the software.
2. **Scene selector**, next or previous.
3. **Speed value** decrease
4. **Speed value** increase
5. **Dimmer value** decrease
6. **Dimmer value** increase
7. **Blackout:** Stops the current scene and plays the scene 00. All DMX levels are set to zero.
8. **Pause:** Freezes the current scene in its state

## Functioning for Interfaces with Modes



1. **Scene trigger buttons** (1 to 15) assigned via the software Trigger 1 to 15 with 1 Zone. Trigger 1 to 9 with several Zone.
2. **5 Control Zones** available: A, B, C, D, E and Global Zone: [ ] to trigger each Zone in the same time.
3. **Increase or decrease** the value of the selected mode: Scene +/-, Dimmer +/-, Speed +/-, Color +/-.
4. **Release Color mode**
5. **Color mode**
6. **Scene mode**
7. **Dimmer mode**
8. **Speed mode**
9. **Blackout:** Stops the current scene and plays the scene 00. All DMX levels are set to zero.
10. **Pause:** Freezes the current scene in its state.

## Functions descriptions

**Scene +/-:** Each push selects the next or previous scene of the current Zone. Scene are play immediately.

**Master Dimmer:** Increases or decreases the RGB, CMY and dimmer channels of the current zone. The CMY, RGB, Dimmer channels are defined in the Profile of the fixture and the stand-alone mode.

**Scene Speed:** Increases or decreases the speed of the current scene in the current zone. A different speed can be chosen separately for each scene.

**Zones:** Choose a Zone (A,B,C,D,E or Global [ ]). Then select a scene or mode to trig in the selected zone.

**Modes:** Select a Mode from Speed, Dimmer, Color or Scenes, then use +/- to change values.

# IR Codes

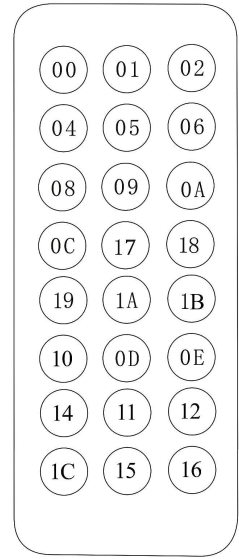
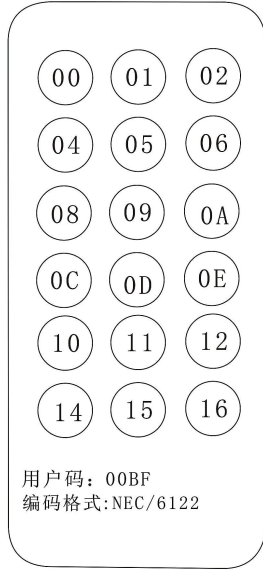
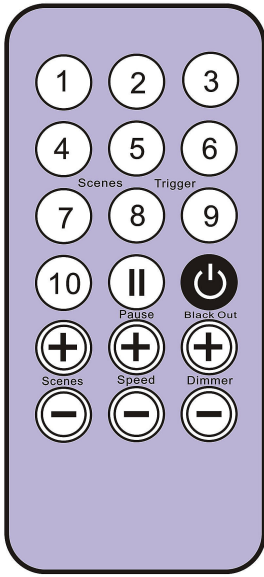

# NODE mode setup

## Setup with the software

### Network setup

Access the device options window:



In the "Ethernet" tab, check "DHCP" to put the device in DHCP mode and apply.

To put the device in static IP mode, uncheck "DHCP" and enter the IP address, subnet mask, gateway, and name, then apply.

### NODE Art-Net or sACN mode

The device's Node mode makes it possible to convert Art-Net and sACN signals to DMX.

In the Node part, select Node Art-Net to change the settings you want.

It is possible to configure names with "Short Name" and "Long Name".

It is possible to change the DMX ports or outputs of the Node by modifying the "SubNet" and "DMX Universe", and then apply.

Select Node sACN to choose DMX and applied Universes.

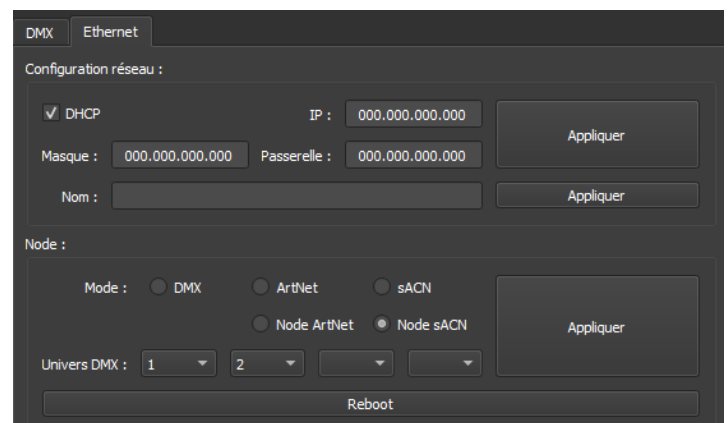
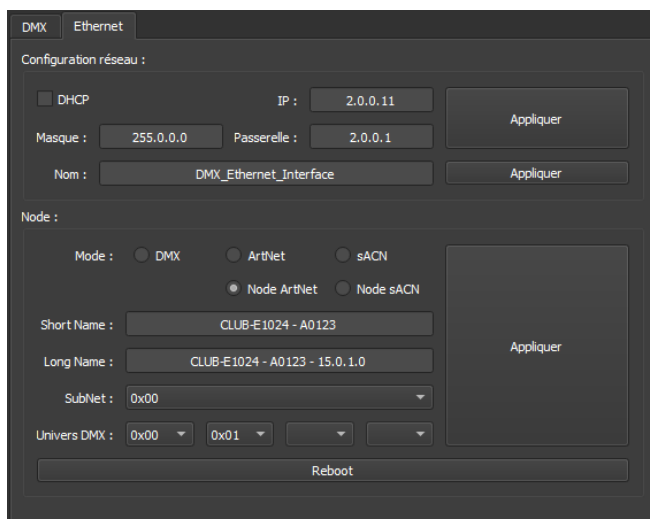

**Press "Apply" to take into account the new settings.**

**To use the device in the selected mode, you must restart the device after configuration by unplugging it from the power supply.**

It is also possible to switch between Art-Net and sACN mode with long support (5s.) on the Device Mode button and following the network configuration of the device.

## Setup with the DeviceTool

### Network setup

Open the device via USB or Ethernet with the option "Open USB Device" or Open "Ethernet Device". Select the "Network" tab.

In the "Ethernet" tab, check "DHCP" to put the device in "DHCP" mode and apply.

To put the device in static IP mode, uncheck DHCP and enter the IP address, subnet mask, gateway, and name, then apply.

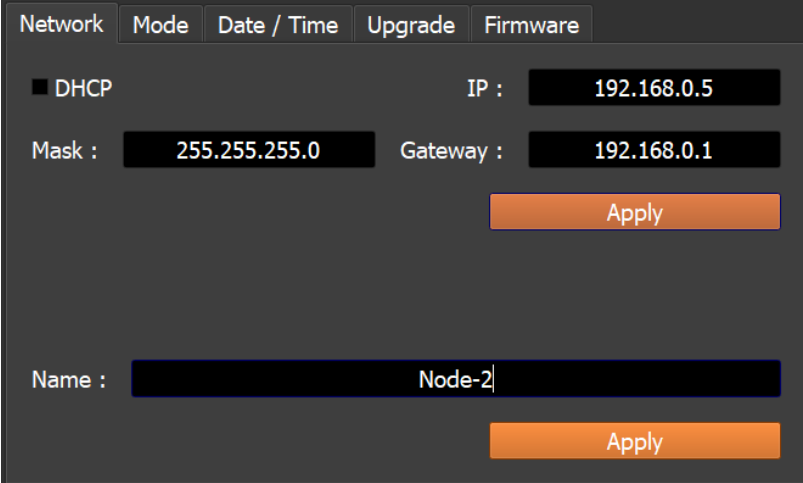

The screenshot shows the "Network" configuration screen in the DeviceTool. At the top, there are five tabs: "Network", "Mode", "Date / Time", "Upgrade", and "Firmware". The "Network" tab is selected. Below the tabs, there is a "DHCP" checkbox which is currently checked. To the right of the checkbox, there are four input fields: "IP : 192.168.0.5", "Mask : 255.255.255.0", "Gateway : 192.168.0.1", and "Name : Node-2". Below each of these input fields is an orange "Apply" button. The "Name" field has a cursor at the end of the text "Node-2".

### NODE Art-Net or sACN mode

The device's Node mode makes it possible to convert Art-Net and sACN signals to DMX.

Open the device via USB or Ethernet with the option "Open USB Device" or Open "Ethernet Device". Select the "Fashion" tab.

Select Node Art-Net to change the desired settings.

It is possible to configure names with "Short Name" and "Long Name".

It is possible to change the DMX ports or outputs of the Node by modifying the "SubNet" and "DMX Universe", and then apply.

Select Node sACN to choose DMX and applied Universes.

**Press "Apply" to take into account the new settings.**



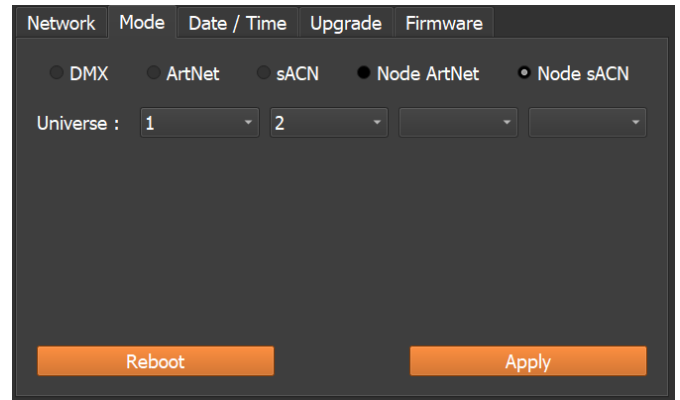
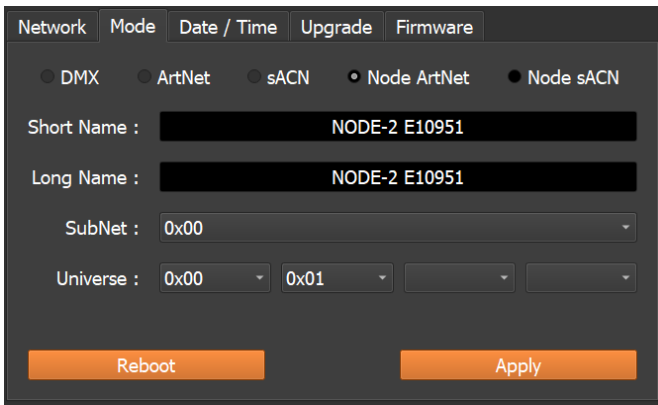

**To use the device in the selected mode, you must restart the device after configuration by unplugging it from the power supply.**

It is also possible to switch between Art-Net and sACN mode with long support (5s.) on the Device Mode button and following the network configuration of the device.

## Setup with a Web Browser

This feature is not currently available.

## UDP, Broadcast, Unicast, Multicast

Art-Net and sACN are communication protocols based on the UDP/IP standard. These 2 protocols integrate DMX frames into Ethernet frames allowing simpler and more convenient wiring with the use of IP switches or WIFI terminals.

Several DMX lines can be encapsulated in an Ethernet frame and therefore reduce wiring to 1 single Ethernet line for X DMX lines.

Art-Net network data is transmitted in broadcast or unicast mode.

Unicast is preferable when using multiple devices on the network and when managing more than 10 DMX universes.

sACN network data is transmitted in Unicast and Multicast.

## Reset the default device

To restore the default values and reset your device, reconfigure the device via USB or Ethernet with the software or DEVICETOOL or application and restart it to take into account the new mode and settings.

It is also possible to change mode directly on the device with a 5 second long press on the mode button.

## NODE wiring diagram

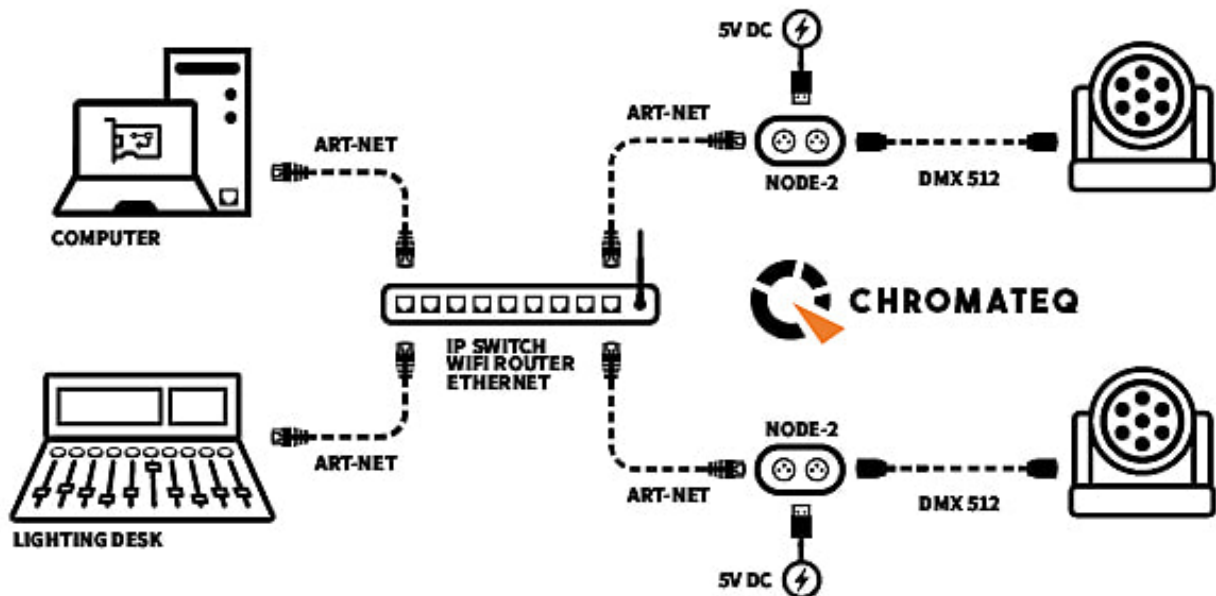

# Detecting NODEs on the network

It is possible to connect multiple devices to the same network in order to multiply the DMX output universes.

## Audit of previous steps

- Assigning IP addresses and subnet masks.
- Configuring devices via the software or DeviceTool.
- Connecting devices to the network.
- Powering devices.

If the steps have been followed, the devices are visible on the network by the software or by other devices compatible with Art-Net frames.

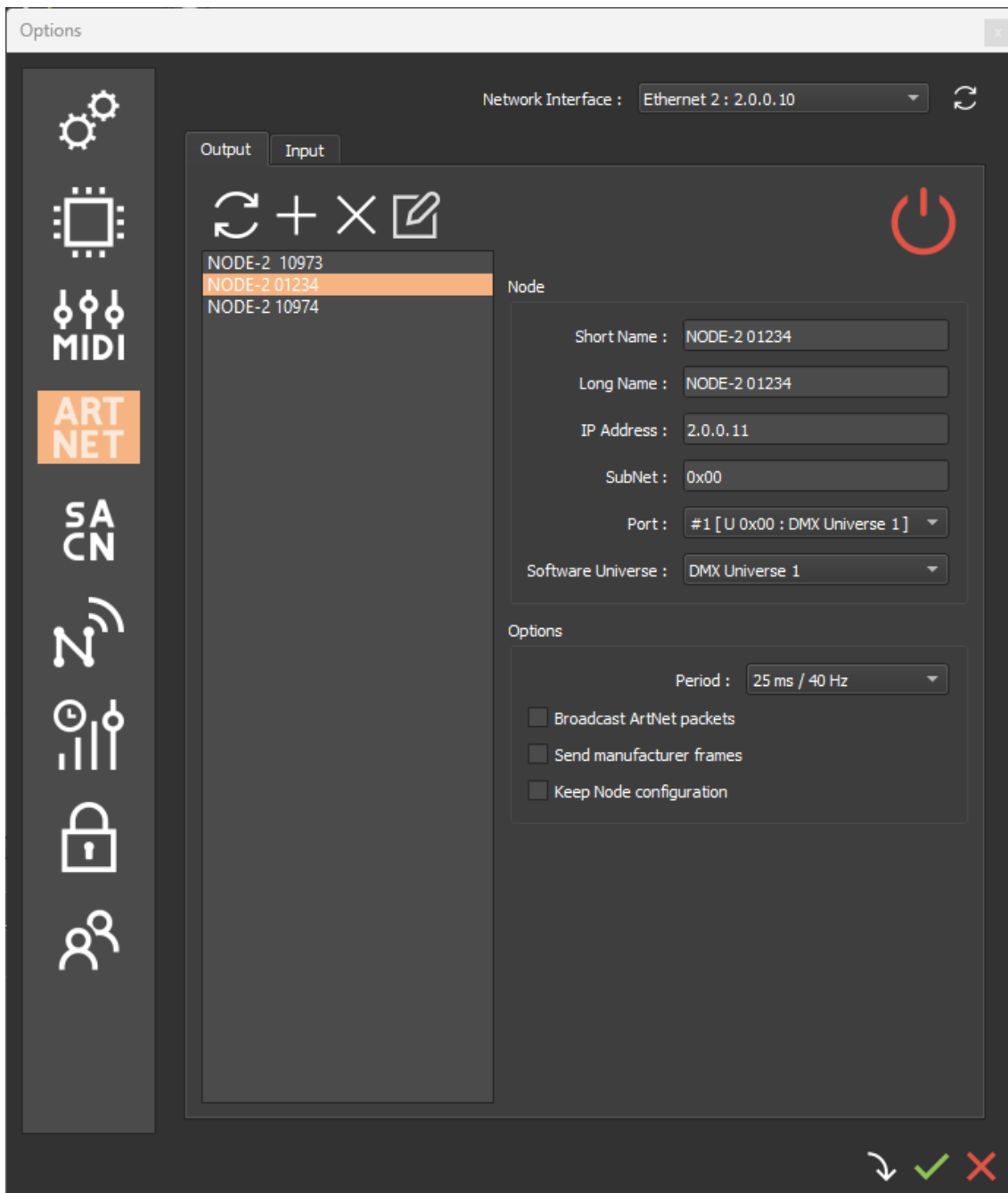

# Art-Net wiring diagram

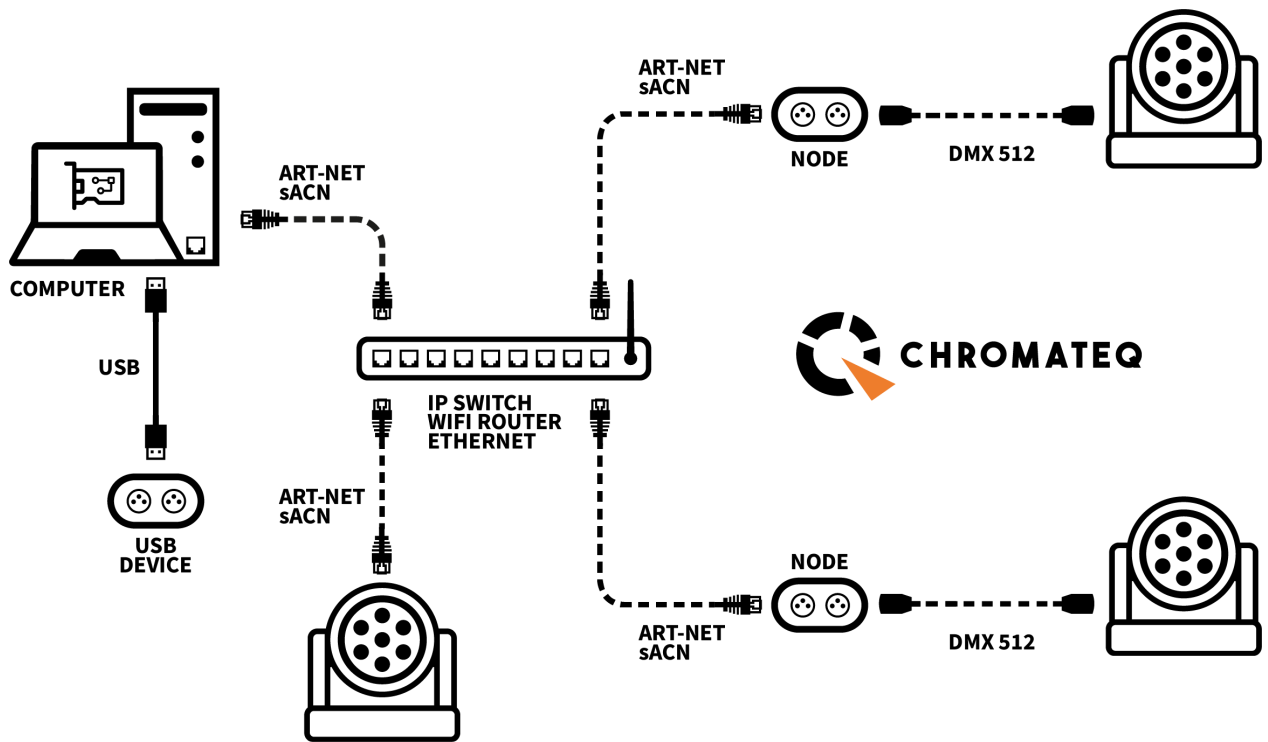

# Housing dimensions

## Front panel

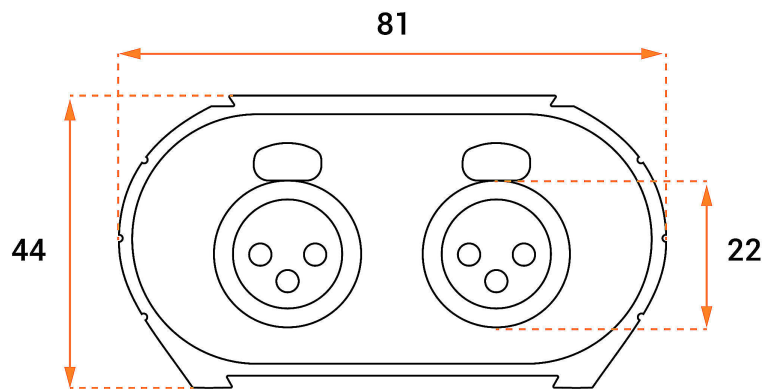

## Back panel

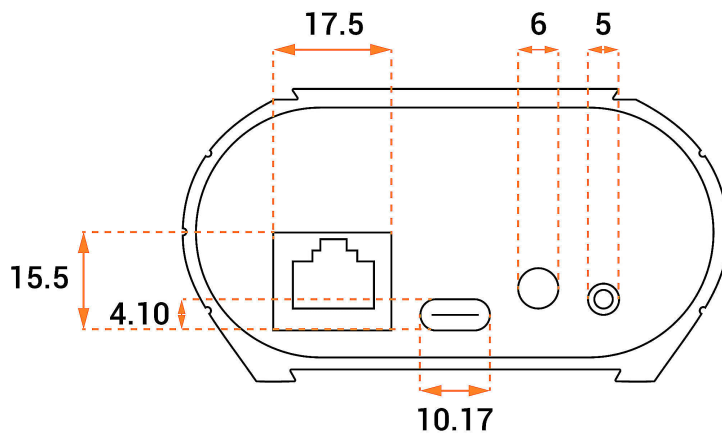

## Tops panel

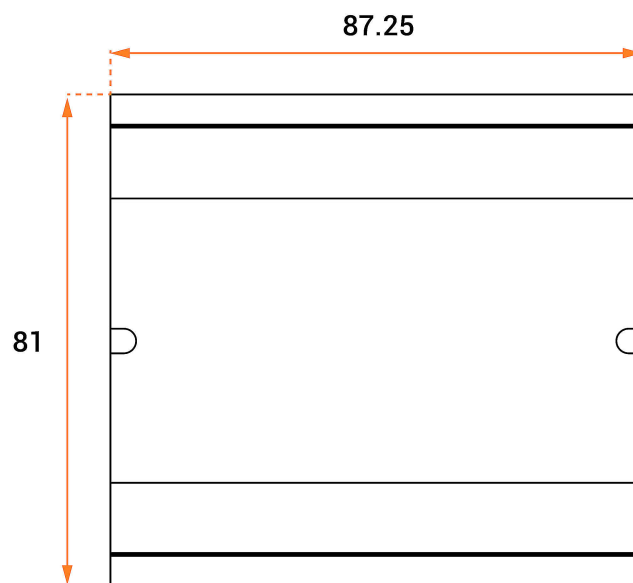

# Troubleshooting

The device is not detected by the DeviceTool or USB software.	Unplug to restart the device.
	Change the USB cable
The device is not detected by the DeviceTool or Ethernet software.	Unplug to restart the device.
	Change the Ethernet cable
	Check the selection of Ethernet networks before opening.
The device is not detected on the network.	Check the mode of communication with LED signals and reconfigure the device via USB if necessary
	Verify that the IP addresses and subnet mask are configured correctly.
	Update the firmware of the device via the software or DeviceTool
	Update the software with the latest version and try again
	Open and allow the Communication Ports used by the device. Some local networks may require manual opening of the following UDP Ports: 8011 + 8012 for communication between the device and software.

If you experience unlisted issues, contact your seller or manufacturer directly to indicate your problem and receive a solution.

Product design and specifications are subject to change without prior notice.

Older devices (sold before 2020) are not compatible with PRO DMX version 2



191 Allée de Lauzard  
34980 St Gély du Fesc, FRANCE  
Web: [www.chromateq.com](http://www.chromateq.com)  
Email: [info@chromateq.com](mailto:info@chromateq.com)  
Phone: +33 952210755

Wechat: Chromateq  
WhatsApp: +8613422062209  
QQ: 2908265661



Guaranteed products: 1-3-5 years  
Software pack: <https://chromateq.com/dmx-software-downloads/>

Copyright © 2021 - CHROMATEQ. All rights reserved.