

DIN-E

512/1024/2048

Ethernet to DMX Stand-Alone interface

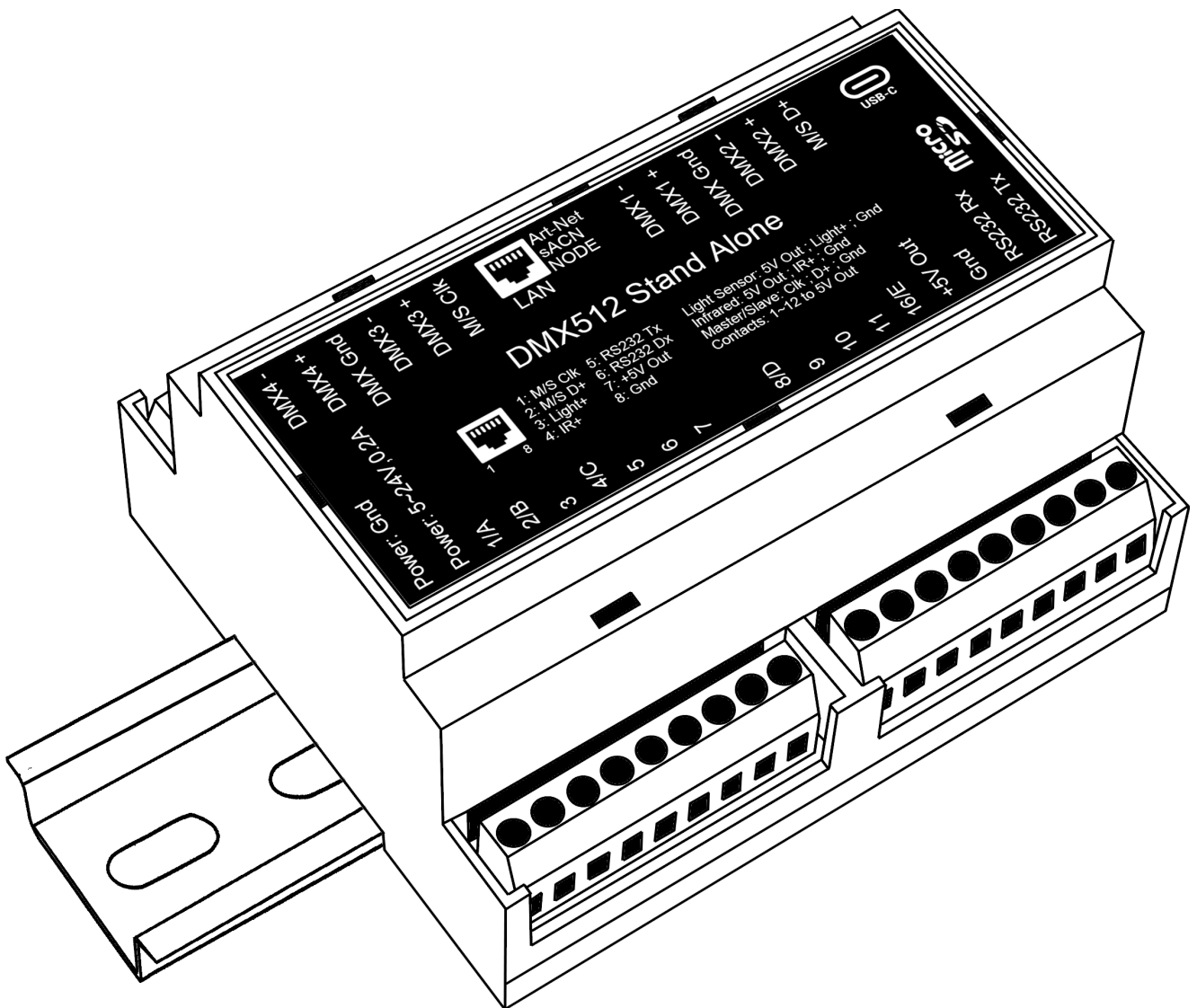

Datasheet &
Quickstart Guide

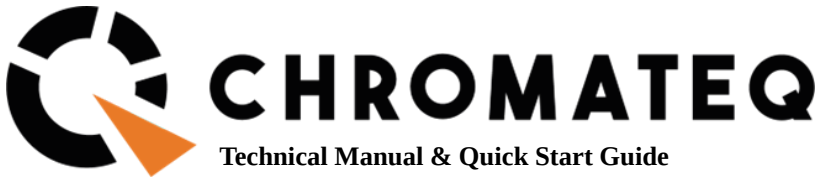

Congratulations on your purchase of a CHROMATEQ controller.

Please read this manual carefully and thoroughly before using the DIN-E Chromateq.

The information presented here provides a useful introduction to the wide range of features, settings and functions available in this compact and versatile DIN-E

The DIN-E Technical Manual is written in English and French.
(Le manuel technique du DIN-E est rédigé en anglais et en français.)

All products and software are developed and designed in France.

CHROMATEQ SARL

191 Allée de Lauzard 34980 St Gély du Fesc FRANCE VAT: FR18521458034 Siret: 52145803400027 Web & E-mail:
www.chromateq.com Phone: +33 952210755 / +86 13422062209 Whatsapp: +8613422062209 Wechat: Chromateq QQ:
2908265661

Twitter: <https://twitter.com/Chromateq>

Facebook: <https://www.facebook.com/ChromateqCompany/>

YouTube: <https://www.youtube.com/c/chromateq>

Copyright Information and Disclaimer

Copyright © 2021 - CHROMATEQ. All rights reserved.

No part of this publication may be reproduced, distributed or transmitted in any form or by any means whatsoever, including photocopying, recording or other electronic or mechanical methods, without the prior written permission of the publisher, except in the case of brief quotations in criticisms and certain other non-commercial uses permitted by copyright law.

For any request for authorization, write to the publisher at the address above.

Trademark credits

Microsoft and Windows are U.S. registered trademarks of Microsoft Corporations. Art-Net™ - Designed by and Copyright Artistic License Holdings Ltd. All other products mentioned herein may be trademarks of their respective ® companies.

Package Contents

- 1x DIN-E
- 1x USB cable
- 1x Power supply 9-12V DC (Euro/US socket)
- 1x software download link and technical documentation

Caution: Check the contents of the package and the condition of the device after unpacking! Contact your supplier if something is missing or is damaged. Do not use the device if it appears to be damaged!

Table des matières

Introduction.....	5
Technical	5
device features	6
Software option.....	6
Connectivity.....	7
USB drivers installation	8
Multiple USB connections.....	8
Ethernet connection and configuration.....	9
DHCP / IP Static.....	9
DHCP connection.....	9
Static IP connection.....	9
Reset of the IP address.....	10
Connecting to a wifi router.....	10
Standalone mode settings	11
Device configuration	11
IN/OUT tab	11
"Merge DMX In / DMX Out" option.....	12
Art-Net/sACN universe range:.....	13
Clock tab.....	13
Options tab	13
Master/Slave tab.....	14
Master/Slave mode "by default".....	15
Commands tab.....	16
Zones tab	16
Scenes selection and configuration	17
Choice of triggers.....	17
Infrared Trigger.....	18
RS232 trigger.....	19
External contacts Trigger:.....	20
Triggers by DMX-IN.....	21
Triggers via Wi-light 2 app and UDP commands.....	21
Advanced trigger options.	22
Restore after power off.....	22
Play in priority.....	22
Time triggers.....	22
Single trigger.....	22
Permanent trigger.....	23
Light intensity trigger	23
Priority of hourly trigger.....	24
Save in memory option.....	25
Basic backup.....	25
Save to an internal and external micro SD card.....	26

Backing up Art-Net or sACN to an external SD card	26
Standalone use.....	27
Switch to stand-alone mode.....	27
External and USB power supply.....	27
Charging the clock battery.....	27
Play a show via a Micro SD Card.....	27
How to use IR Remote.....	28
Previous Remote Control Unit (Before 2022).....	28
Functioning for devices without Mode and older devices.....	28
Functioning for devices with Modes.....	28
New Remote Control Unit (2022).....	29
Functioning for devices without Mode and older devices.....	29
Functioning for devices with Modes.....	29
Functions descriptions.....	30
IR Codes.....	30
IR receiver box.....	31
NODE mode configurations	32
Setup with the software.....	32
Network setup	32
NODE Art-Net or sACN mode.....	32
Setup with the DeviceTool.....	33
Network setup	33
NODE Art-Net or sACN mode.....	33
Configuration with a Web Browser.....	34
Udp, Broadcast, Unicast, Multicast.....	34
NODE wiring diagram	35
Reset default device.....	35
Network NODEs detection	35
Dimensions.....	37
Wiring Diagram.....	38
General wiring diagram.....	38
Standalone Art-Net wiring diagram.....	38
Master/Slave Standalone wiring diagram.....	38
Troubleshooting	39

Introduction

DIN-E is the ideal DMX standalone device for installation in electrical DIN cabinets with DIN RAILS. The USB to DMX standalone Ethernet DMX device can control from 512 to 2048 channels on 1, 2 or 4 DMX universes.

Featuring a robust standalone mode and a wide range of trigger possibilities (RS232, Contacts, Clock, NODE x4 ports, Master/Slave on LAN), this competent device is a smart solution for easy and quick architectural installations and large integration projects.

Objectives

The purpose of this technical manual is to develop the options managed by the device in standalone mode, for software options, please refer to the software manuals.

Technical features

Connectors	USB-C, Screw terminal (2x9+2x6 pins) Ethernet and RJ45 (External contact x12, Master/Slave, Infrared, Light Sensor, 5S232 in/out)
DMX lines	Up to 4 x 512 channels 8 and 16-bit DMX channels
Internal memory	yes, 4MB (no SD card required)
Internal memory capacity	20000 steps with 16 hp., 6000 steps with 512 hp., 3000 steps with 1024 hp.
External memory	Micro SD card (accepts FAT, FAT 32, Class 10 SD card up to 256 GB)
CPU	32-bit processor
Power supply	5V to 24V DC, 0.2A/5V via USB-C
Power / Consumption	0.3 ~ 0.5 W
IP rating	IP20
Dimensions (mm)	H: 106 mm, W: 90 mm, D: 59 mm (pcb: 103/87/19)
Net weight (device)	170 Gr. (0.37 lbs)
Gross weight (full cost)	0.3 Kgs (0.66 lbs)
High voltage protection	Yes, fuses and diodes
Color	Beige
Environment of use	Interior
Storage	Store dry
Temperature of use	- 25 to +70 C°
Certifications	CE, RoHS
International guarantee	Yes, 5 years
Compatibility of systems	Windows (7 and higher), MAC OS X (10.13 and higher) and Linux (64 Bits, Debian, Redhat, Archlinux, Raspberry Pi)

device features

DMX 512	4x512 output (Splitter, PC + standalone) or 512 output and 512 in input (PC only, DMX recording, DMX IN trigger, DMX merge)
DMX 1024	2x512 output, 1024 in output or 512 output and 512 in input (PC and standalone mode, DMX recording, DMX IN trigger, DMX merge)
DMX 2048	4x512 output, 2048 in output or 1024 output and 512 in input or 1536 output and 512 input (PC and standalone mode, DMX recording, DMX IN trigger, DMX merge)
Multiple zones (DMX 1024/2048 mode only)	5 zones, plays up to 5 scenes simultaneously
Combined areas (DMX 1024/2048 mode only)	yes
Clock in real time - RTC	Time and calendar triggering
Smart contacts	12 (31 maximum)
Master/Slave synchro	Yes, 32 max per wiring / 128 max LAN
RS232 In/out	Triggers + commands
Infrared remote / Light sensor	Optional (Requires the IR Kit) 15m. distance max.
UDP	Ethernet triggers and commands

Software option

	Line DMX	Art-Net	Options
Software Player	512/1024/2048 DMX channels	1 universe (512) 2 universes (1024) 16 universes (2048)	Live Board mode
Software Pro DMX	512/1024/2048 DMX channels	1 universe (512) 2 universes (1024) 16 universes (2048)	Normal mode, 30 min audio and video timeline loop(512/1024) 24h audio and video timeline loop (2048)
Pixel mapping software	512/1024/2048 DMX channels	4 universes (512) 8 Universe (1024) 64 universes (2048)	Normal mode, 30 min audio and video timeline loop(512/1024) 24h audio and video timeline loop (2048)
Studio DMX 3D viewer	Full mode		
Wi-Light 2 App	Controls Player, Pro and Pixxem software over a local WiFi network		

Free software updates	Yes
-----------------------	-----

Connectivity

1- 9 Pins Terminal Block

- GND
- VCC 9-24V
- TRIG A/1, B/2, 3, C/4, 5, 6, 7

4- 9 Pins Terminal Block

- TRIG D/8, 9,10, 11, E/16
- 5V OUT
- GND
- RS232 Rx
- RS232 Tx

3- Micro SD Class 10

4- RJ45 Pinout

1. M/S Clock
2. M/S Data+
3. Light+
4. IR+
5. RS232 Tx
6. RS232 Rx
7. 5V
8. GND

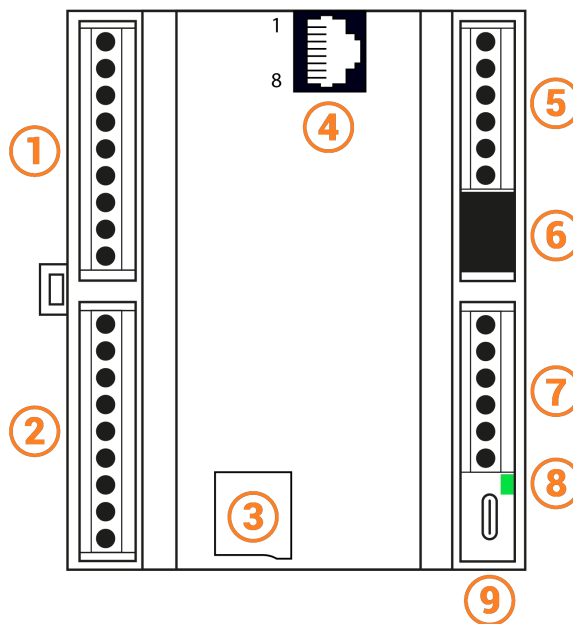

5- 6 pins Terminal Block

- DMX 4-
- DMX 4+
- DMX GND
- DMX 3-
- DMX 3+
- DMX M/S Clock

6- RJ45 Ethernet

2- 6 pins Terminal Block

- DMX 1-
- DMX 1+
- DMX GND
- DMX 2-
- DMX 2+
- M/S Data+

8- LED

9- USB-C

LED signal correspondence	
OFF	device is not powered (check the power) or have a problem.
Normal Blinking	USB communication with software is enabled.
Slow Blinking	device is in standalone mode.

USB drivers installation

Install USB drivers to communicate with the device and change settings. Installation of USB drivers is required only for Windows at the end of installation. Drivers for Mac and Linux systems are installed automatically.

USB drivers verification :

In the Windows Device Manager. Check that the device icon is visible in "USB Bus Controllers".

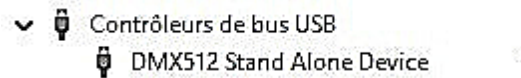

If drivers are not installed, the Windows Device Manager lists a device with a yellow warning.

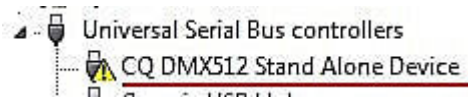

On Mac OS, simply check the USB device tree to view "DMX 512 standalone Device". On Linux, use the "lsusb" command to view "DMX 512 standalone Device" as a list.

After control software installation and USB drivers

- Connect the device with the USB cable.
- Start the DEVICETOOL or the software and select "Open USB Device" or "USB" to check the success of drivers installation.

All connected and detected devices are listed.

Multiple USB connections

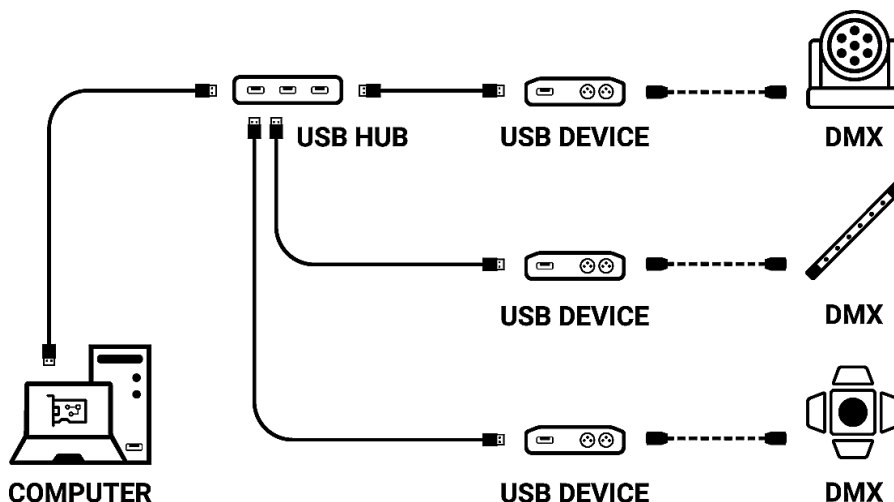

Ethernet connection and configuration

Establish Ethernet communication with the device to change its settings in the software options window or via the DEVICETOOL.

It can be done in several ways: Live, via an IP Switch or a Wifi router. The device is in DHCP mode by default.

Initial steps required

- Connect the device to the LAN or computer via an RJ45 Ethernet cable.
- Power the device via USB cable (5V DC, 0.3A).
- Connect the computer to the same network (LAN) or device via an RJ45 Ethernet cable.

DHCP / IP Static

In DHCP mode, without responses from a DHCP server after a short time, the device will use static IP mode with its default IP address and wait for the next DHCP request to use DHCP mode. It will therefore always be possible to connect directly to the computer in static IP MODE. The device is in DHCP mode by default.

DHCP connection

DHCP mode, allows you to communicate with devices through a DHCP server that automatically assigns and manages the IP addresses of each device. The DHCP server can be of Switch IP or Router type or other.

The device is in DHCP mode by default.

It is detected by software automatically when the computer is also connected in DHCP to the same network or with a static IP address of the same range.

DHCP benefit is that the DHCP server automatically manages the IP addresses of connected devices. So it is not necessary to know exactly the IP of your device to connect to it. However, IPs are regularly modified and can make the installation less reliable.

Setting up the DHCP connection

- After the required initial steps are completed.
- If the device is in DHCP mode (default mode).
- Also configure the computer in DHCP mode.
- Start the software or DEVICETOOL by selecting "Open Ethernet Device"

Static IP connection

Static IP mode, allows you to communicate directly with an device without necessarily going through another device such as IP switch or router or access point. It is also used on LANs without DHCP server.

Static IP mode also allows you to freeze a network configuration and provides better stability to installations designed with multiple devices thanks to an IP switch or routers.

The default static values of the device are:

IP address: 192.168.0.5

Subnet mask: 255.255.255.0

Setting up the Static IP connection

- After the required initial steps are completed.
- If the device is in Static IP mode.
- Set the IP address of the computer to an identical IP address range of type 192.168.0.x. With "x" different than 5 to avoid identical IP conflicts on the network.
- Also set the subnet mask to 255.255.255.0.
- Start the software or application.

In an identical IP address range, the device will be recognized when software starts.

Reset of the IP address

If there is a default IP address not found, use the USB connection and software settings tools to check or change the device IP address.

Connecting to a wifi router

If the device's RJ45 port allows a wired connection to a local network, it is also possible to connect to it via WIFI via a WIFI router.

The illustration below is an example of a configuration using a third-party mini WiFi router to allow a wireless connection. Other descriptions of these routers can be "hotspot", "hub", "dongle", "bridge", "repeater", etc.

Note: Connect multiple devices to the WiFi router or extend the available RJ45 ports with a Switch IP.

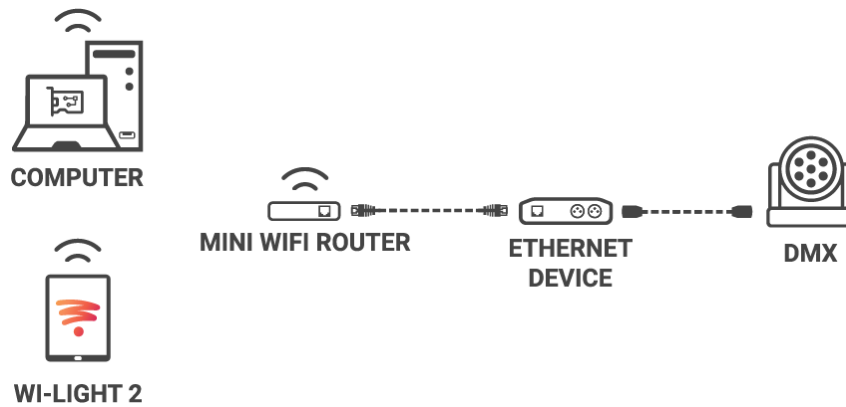

Implementation of the WIFI network:

- Set up the WiFi router as a Hotspot to create a new access point.
- Or configure the WiFi router as “Bridge” or repeater to join an existing network.
- It is possible to configure the router in Static IP or DHCP.
- In DHP (default mode of a router) IP addresses are dynamically assigned on the network by the DHCP server.
- After configuring the router, connect the RJ45 ports and configure the device in DHCP or static IP mode.
- Once the device is connected to the router, it can be used and visible on the network.

Standalone mode settings

In standalone mode of the control software,  configure the device according to the available options then select and configure the triggers of scenes to be written in memory.

Device configuration

IN/OUT tab

Select a DMX input/Output configuration of the device from the drop-down menu

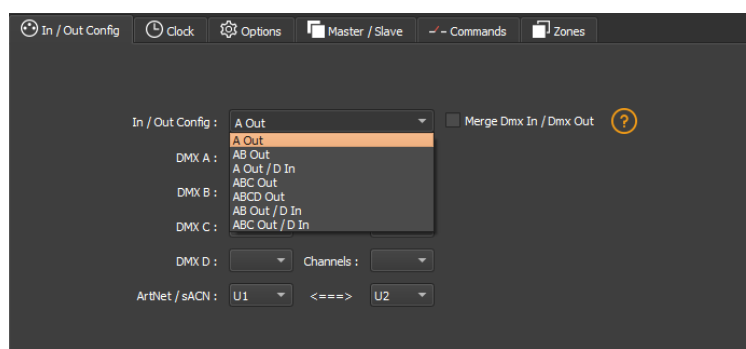

Available configurations will be displayed depending on the connected device depending on whether it has 1.2 or 4 DMX lines.

- **A OUT** - Assigns 1 output universe on the DMX line(s), for devices that have more than 1 DMX lines duplicate the universe on each.
- **AB OUT** - Assigns 1 different output universe on 2 DMX lines, for devices that have 4 DMX lines duplicates the first 2 lines on the next 2 lines.
- **A OUT/B or D IN** - Assigns 1 output universe on the first line(s) and uses the last DMX line as DMX input.
- **ABC OUT** - Assigns 1 different universe output on the first 3 DMX lines.
- **ABCD OUT** - Assigns 1 different universe output on 4 DMX lines.
- **AB OUT / D IN** - Assigns 1 different output universe on the first 2 lines and uses the last DMX line as DMX input.
- **ABC OUT / D IN** - Assigns 1 different output universe on the first 3 lines and uses the last DMX line as DMX input.

"Merge DMX In / DMX Out" option

Available with devices with more than 2 or 4 DMX lines.

Enable the option to re-inject line configured as an input (IN) to the line(s) configured in DMX outputs and thus merge them.

The merged DMX levels are compared and the highest is retained. We are talking about HTP (Highest Takes Priority).

Maintain manual control on some circuits with an external DMX console.

Create a multi-zone system by merging several cascading devices to obtain only one common DMX line.

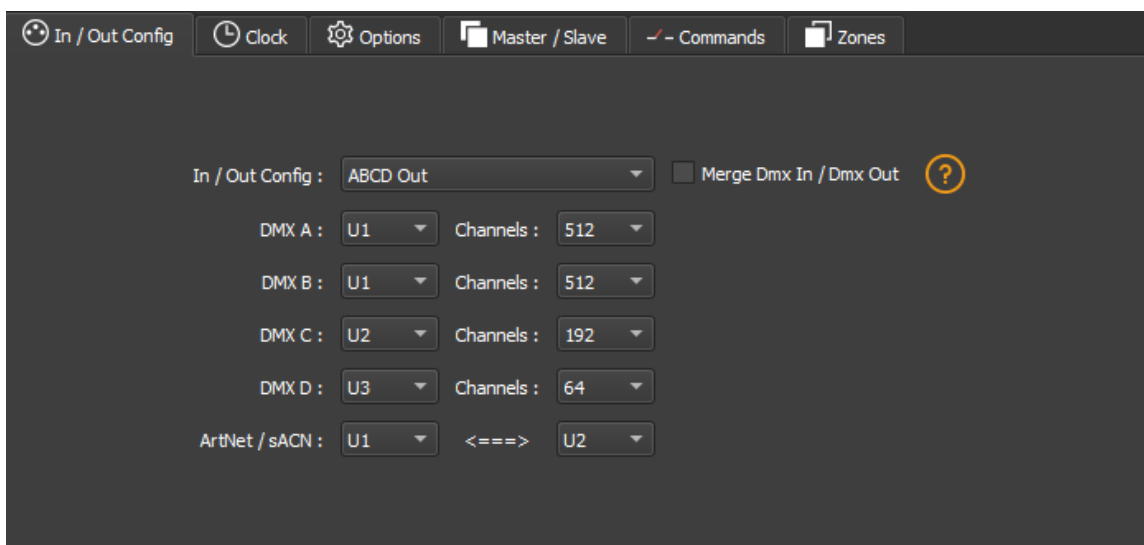

Assign any universe of the software to any DMX line assigned to output, choosing line by line (U1, U2...).

Optimize the size of shows saved in memory by reducing the number of circuits per universe depending on the channels used.

Example: If 150 channels are used in the show, select only the nearest higher value, here 192.

Art-Net/sACN universe range:

Define the starting universe and the finish universe to write in memory on an external SD card for an Art-Net/sACN show.

Cf. "Saving Art-Net or sACN to an external SD card"

Clock tab

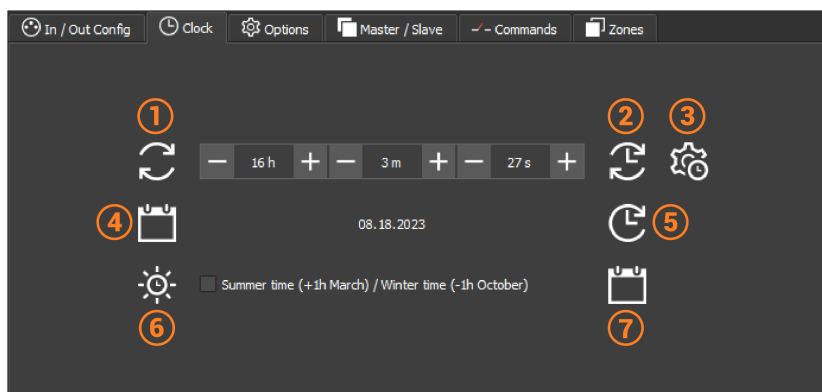

Set up the selected device's internal clock.

1-Update the time in real time

2-Update the time after changing the hours/minutes/second fields.

3-Calibrate the compensation time according to the observed deviation.

4-Update the date.

5-Sync the date and time of the device with that of the computer.

6-Check to take into account the change of summer/winter time

7-Select the days of change of summer/winter time

Options tab

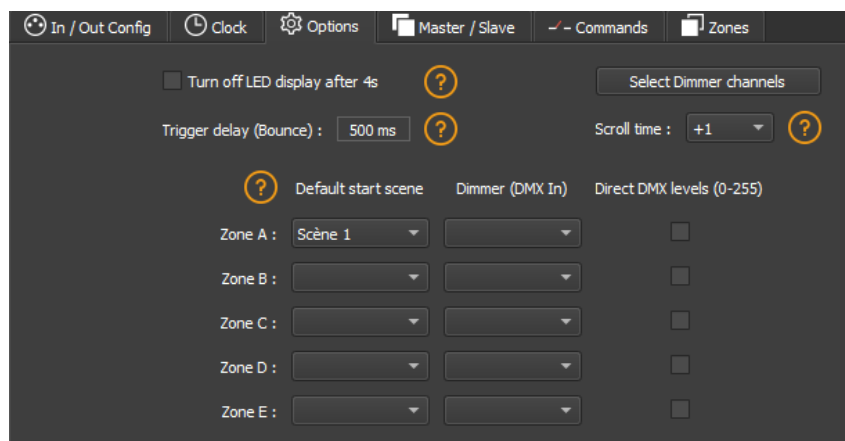

For devices with an LED display, turn it off after 4 seconds of inactivity by checking the option.

Select a default scene to play automatically after the device is turned on (with USB or external power supply). For multi-zones devices it is possible to set a default scene for each area.

Note: The selected default start scene loses its priority if another scene uses the "Restore if power off" option.

Cf. "Advanced trigger options"

Configure the "Select Dimmer channels" option to select separately the Dimmer or RGBW light intensity channels that will be controlled directly by Dimmer mode, dry contacts or via the infrared remote control.

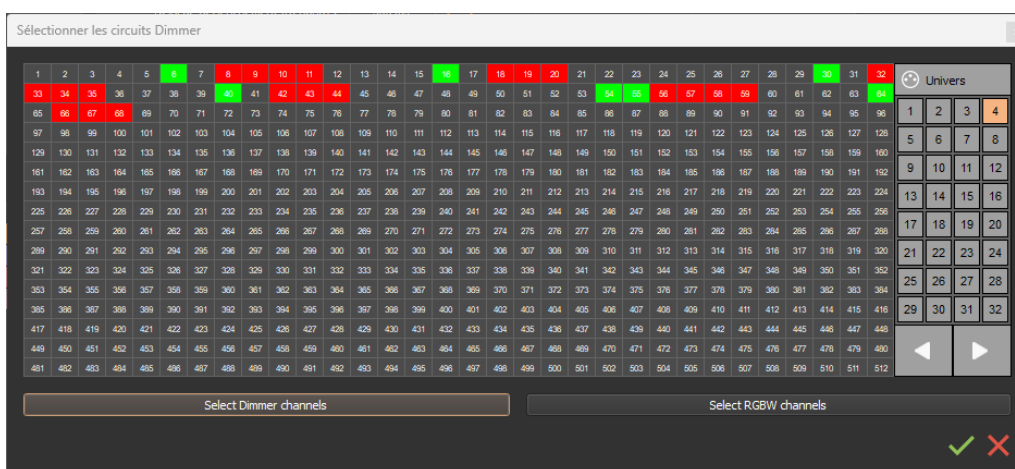

Master/Slave tab

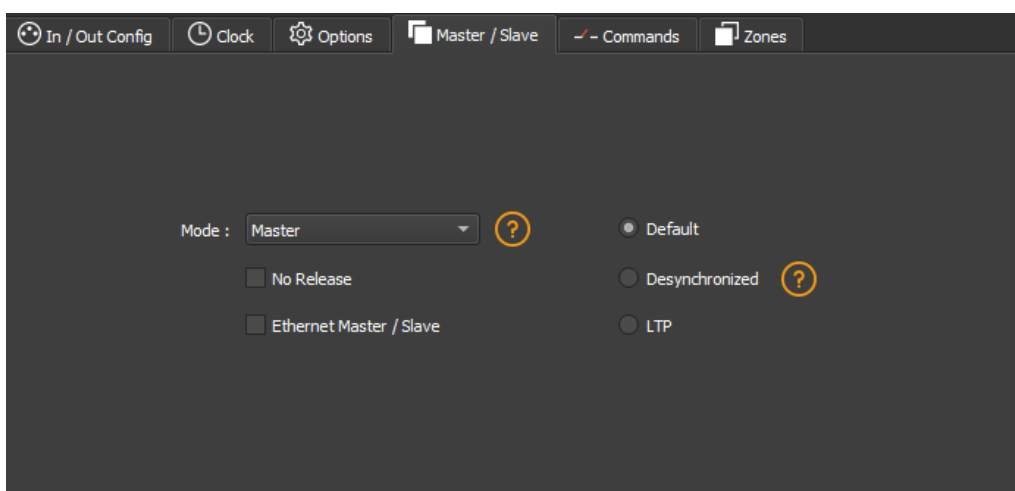

Connect multiple devices into USB so that they are detected by the software. Use the Master/Slave option to synchronise their standalone mode and DMX universe. When a device is set as a master in the software, the other devices are automatically put in slave mode. There are four different modes of master/slave interaction: By default, desynchronized, LTP,

and no release.

Master/Slave mode "by default"

A single device is defined as master (lower serial number by default), the others are automatically defined as slaves. The master device plays the current scene and synchronises the slave devices. The master forces slave devices to play the same scene and the same stage step simultaneously. Slave devices are forced to track the timings and triggers of the master and they cannot act otherwise, play or trigger a scene independently. The master can trigger and stop scenes from slave devices.

"Desynchronized" Master/Slave mode

One device is defined as master, the others are automatically defined as slaves. All master device triggers are transmitted to slaves. However, slave devices are not synchronised with the master device synchronisation signal and retain individual control. Therefore, slaves can trigger and play different scenes at any time and not synchronised perfectly with those of the master. The master acts as a general remote control imposing the trigger on slaves with total priority. The master can trigger ON and OFF scenes from the slave device.

Master/Slave mode "LTP"

LTP means "Latest Takes Priority / The latter has Priority". All devices are defined as slaves. The devices are not synchronised with timing and can trigger and play different scenes by themselves. However, device triggers are automatically transmitted to other connected devices and slave devices are forced to trigger the same scene. In this mode, each device acts as a general remote control imposing triggering on other slaves without synchronisation.

Master/Slave mode "No release"

This option is only available with LTP or DESYNCHRONIZED modes. Only ON triggers of the master device are executed and functional. All OFF triggers are ignored and slave devices continue to play their current scene. Each slave device can choose whether to release its scene depending on whether the option is enabled or not.

Cf. *"Wiring diagram for Master/Slave installation"*

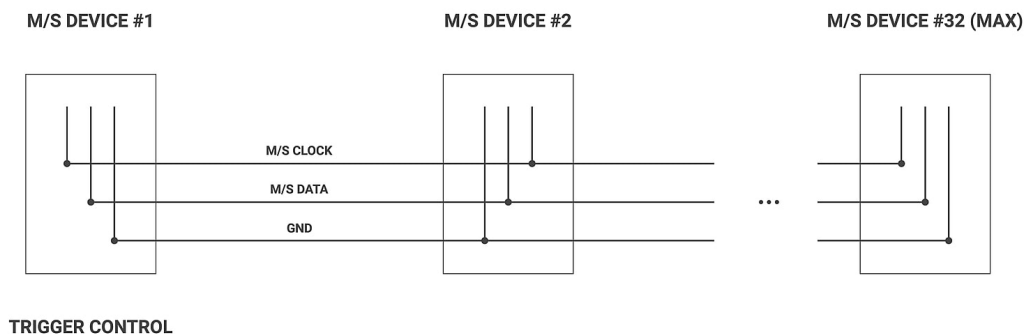

Commands tab

Assign external contacts, among those available for your device, to trigger some standalone mode commands: Dimmer +, Dimmer -, Blackout, Speed +, Speed -, Pause, Scene +, Scene - and Zone.

Note: Be careful not to use the same command trigger as the one used for a scene and vice versa. Cf. "Choice of triggers by external contacts"

The last assigned contact will take priority over the other.

Use 2 types of Short/Hold contact and thus assign an identical contact to 2 different commands. (here as an example with the Dimmer +; Dimmer -)

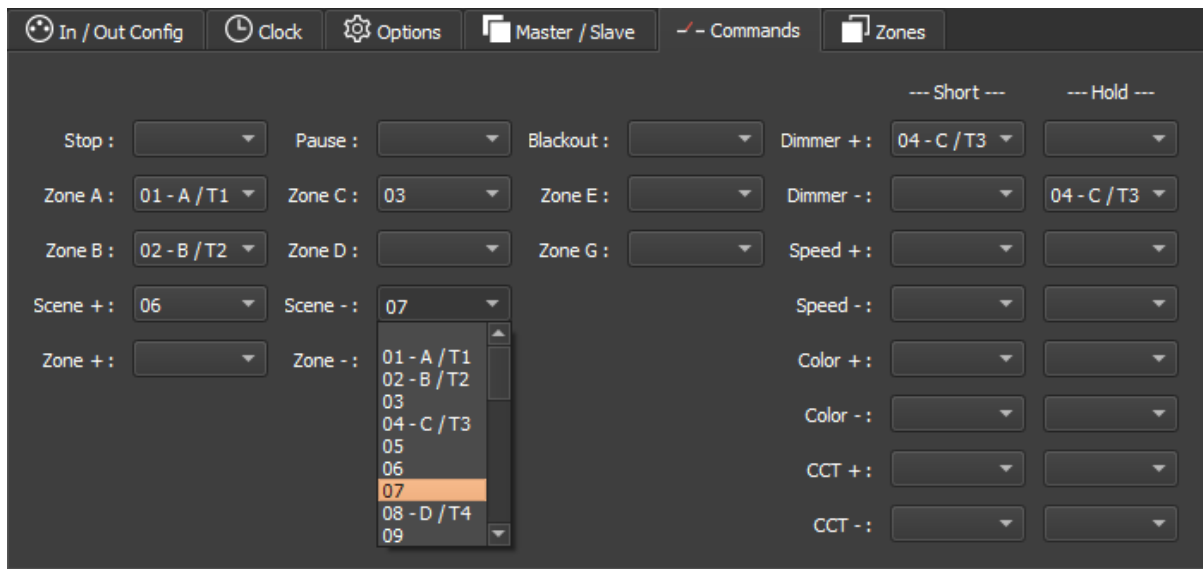

Zones tab

The multi-zone option allows you to play multiple scenes simultaneously in defined areas.

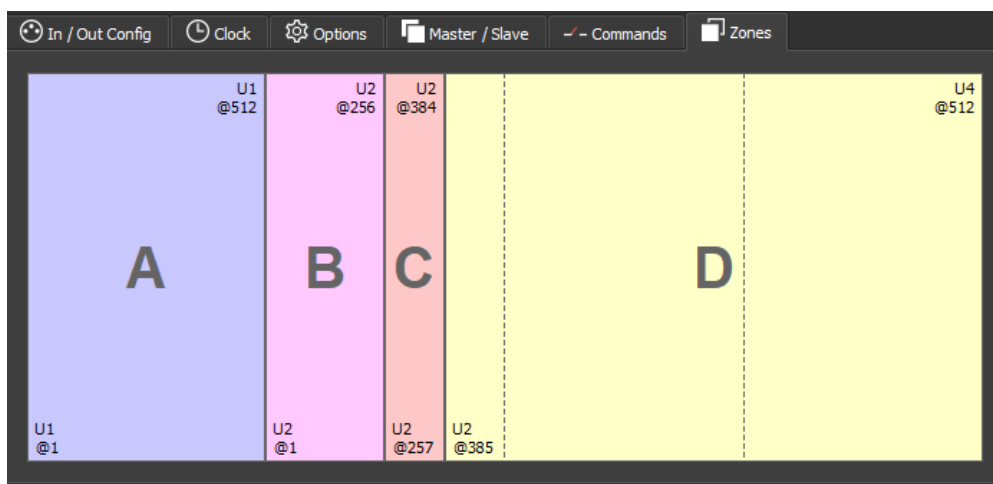

The tab displays the DMX configuration summary of the associated DMX zones and addresses.

Double-click to switch to **edit mode**.

Set the area settings manually, moving the centrer bar or digitally choosing the range of the area in the fields.

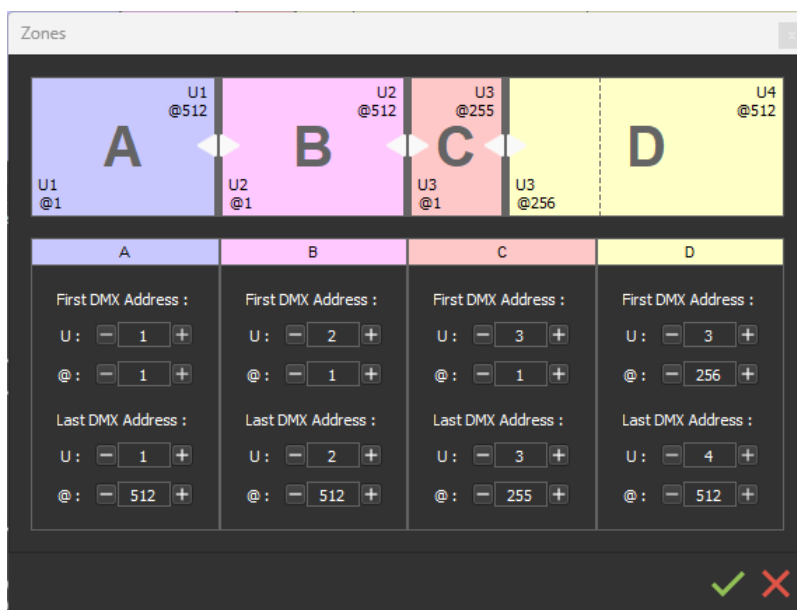

Note: Verify that the addresses of DMX patches and devices match the defined areas.

Scenes selection and configuration

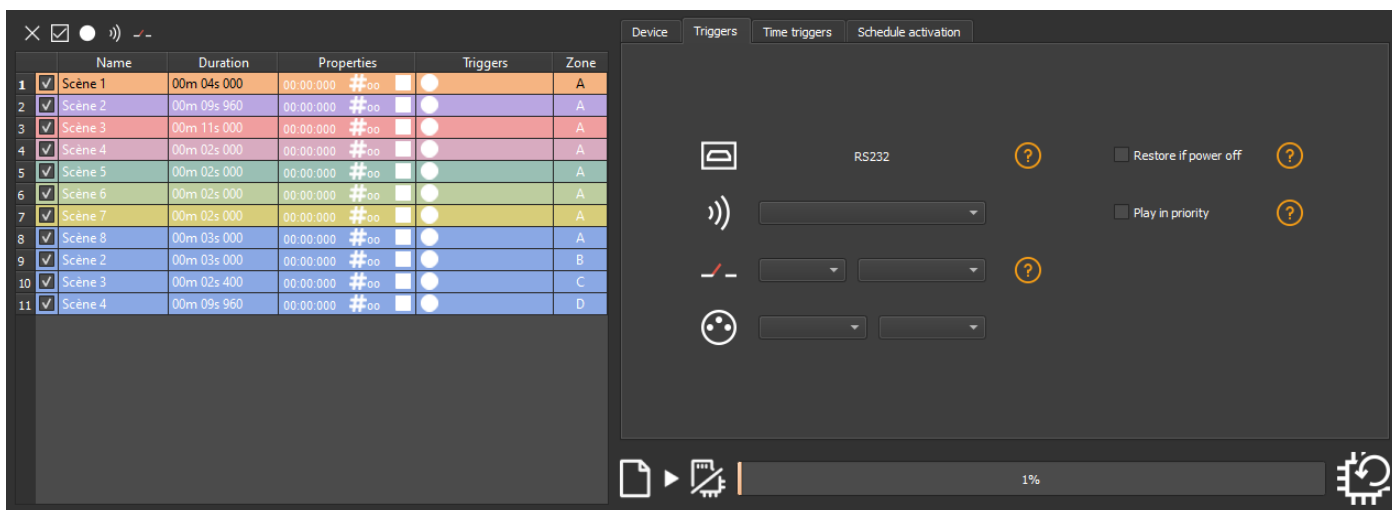

Check to select the scenes to write in memory and assign triggers from those available by your device.

Choice of triggers

In the "Triggers" tab, select and assign different types of triggers.

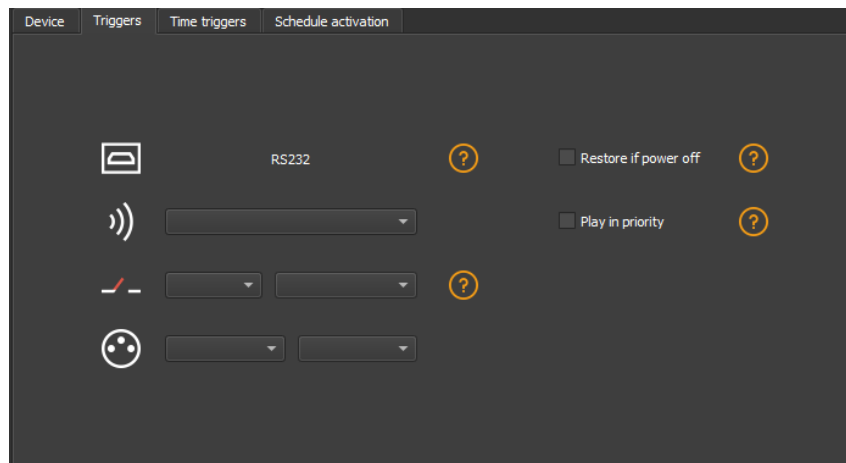

Infrared Trigger

For devices that do not have this trigger option an Infrared kit is available containing an IR receiver and a remote control.

Cf. *"use of the remote control by infrared"*

Select a scene from the list and assign it a remote control button from the 15 available buttons.

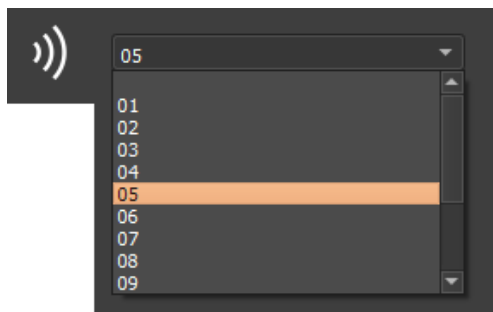

Automatically assign buttons to all scenes in the list by clicking the Infrared icon on the scene list toolbar.

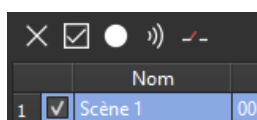

RS232 trigger

Use RS232 as a receiver to control the device via another device with the commands also described in the Software Help topic.

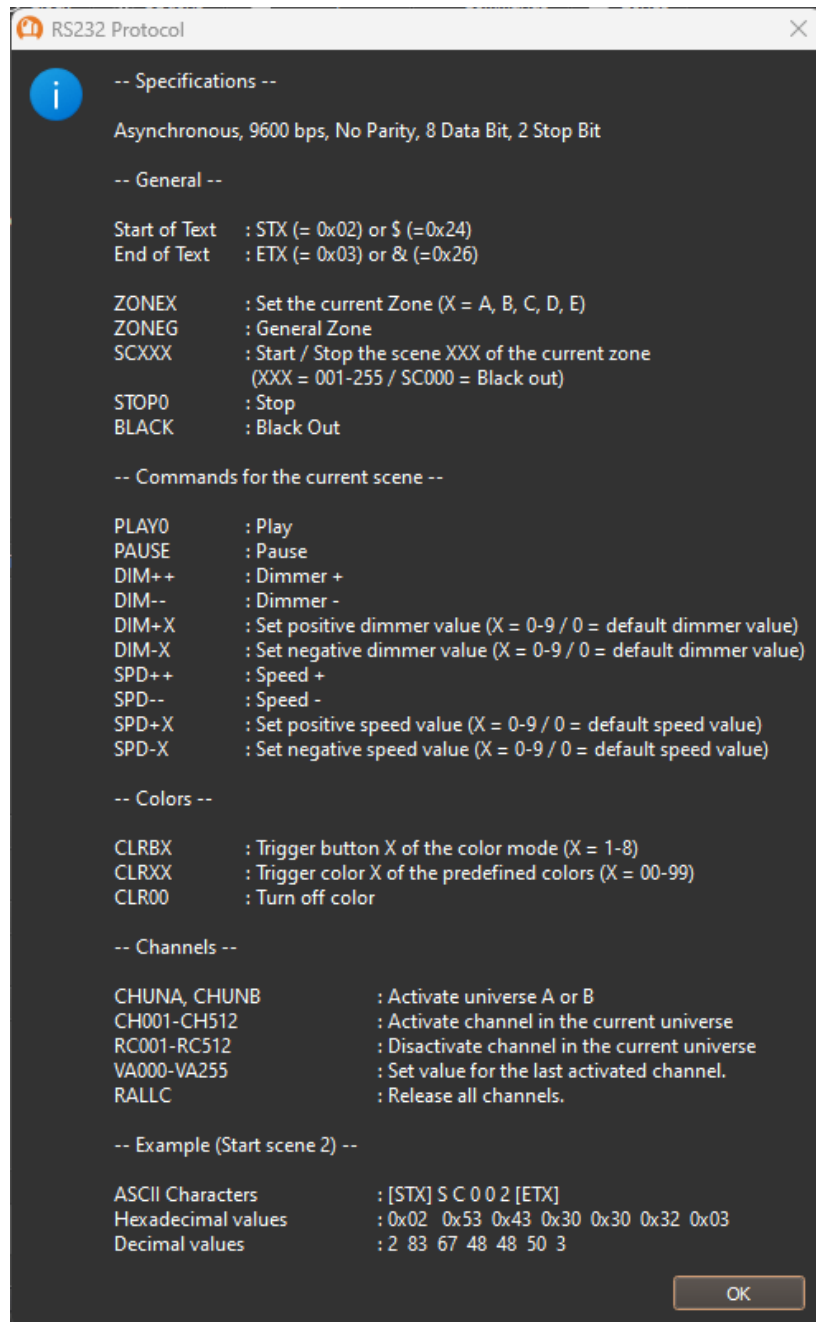

External contacts Trigger:

Depending on the device, several external contacts are available: Trig A, Trig B, Trig C ..., and the Use a multiplexing device to extend the number of contacts when possible.(from 3 to 7; from 4 to 15; from 5 to 31 ...) Contact reaction time, 5ms (0.005s)

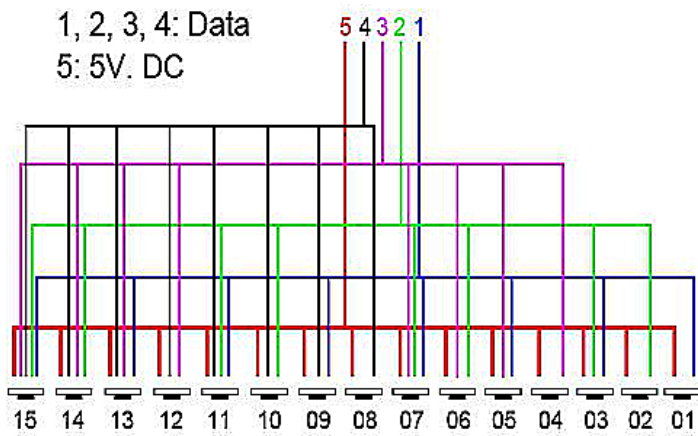

Example of multiplexing system with 4 external contacts extended to 15.

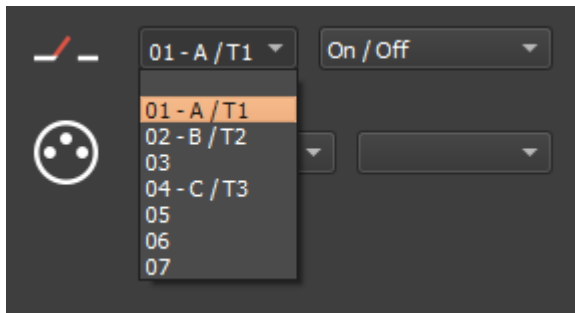

Select a scene from the list and assign it a contact from those available through the device.

Option of triggers

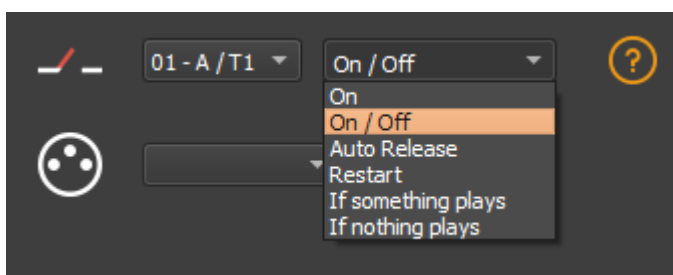

Select a trigger option from the drop-down menu next to it.

On: Activating the contact makes the scene play (the only trigger action is to start the scene).

On/Off: Activating the contact starts the scene, subsequent activation stops the scene. Each trigger action will reverse the stage state (start/stop).

Auto Release: The scene is played only while the contact is enabled. When the contact is released, the scene stops.

Restart: If the scene is playing, enabling the contact restarts the scene from its beginning. If the scene is not being played, it will start. External contact reaction time: 8 ms (0.008 s) / time between 2 contacts: 500 ms (0.5 s)

If something plays: Play the selected scene if a scene is already played.

If nothing plays: Play the selected scene if nothing plays.

These two interdependent options allow the same contact to be assigned to two different scenes.

Note: Be careful not to use the same scene trigger as the one used for a command and vice versa.
Cf. "Order tab"

The last assigned contact will take precedence over the other.

Automatically assign external contacts to all scenes in the list by clicking the external contact icon on the scene list toolbar.

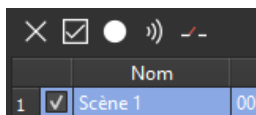

Triggers by DMX-IN

255 trigger channels and up to 255 levels per channel are available.

Select a scene from the list and assign it a channel number associated with a trigger level. A trigger level corresponds to the threshold above which the scene is triggered.

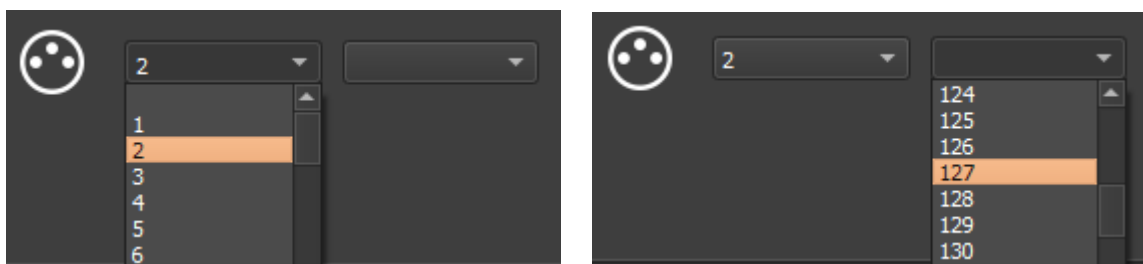

Note: To configure triggers in DMX-IN, one of the DMX lines must be Select as input in the "IN/OUT Config tab."

Triggers via Wi-light 2 app and UDP commands

When connected to a local network with a WIFI access point, it is possible to trigger and control the device with the Wi-Light 2 app for Android and iOS when it runs in standalone mode. This local mode is also available on the internet with the Web Remote option.

Each device, device and mobile, must be connected to the same access point in DHCP (recommended) or fixed IP mode. The application will then detect the device and display the list of scenes and other possible controls and commands. The Web Remote control option requires you to create a user account and save your devices locally first. Please refer to the Wi-Light 2 manual to use this mode.

The Wi-Light 2 app uses an open protocol for developers with standard communication based on simple UDP commands.

Third-party software can establish UDP communication with the software/device and control it using predefined JSON commands. Option only available with devices with an Ethernet port. (see "Communication Development Kit User Manual")

Advanced trigger options.

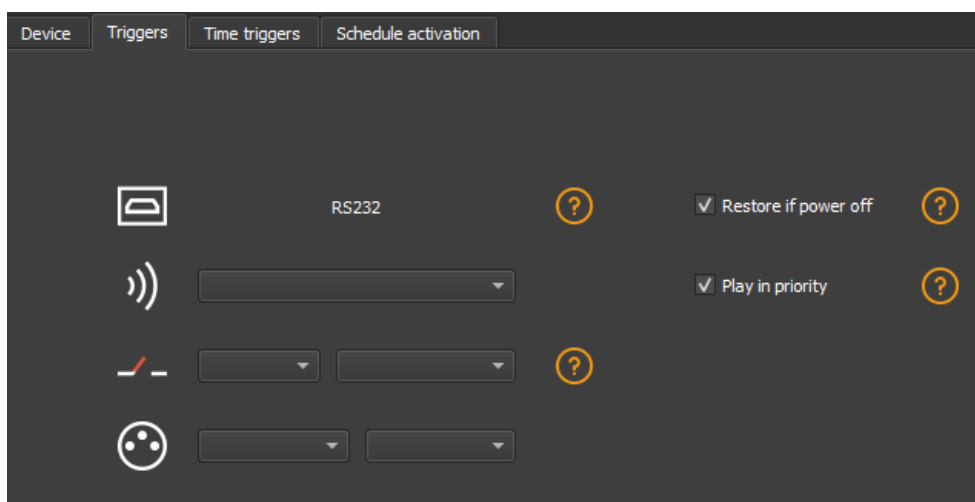

Restore after power off

By checking this option in the "Triggers" tab, the selected scene takes priority on the boot scene (see "Options tab") when the power supply is restored.

If all scenes have the option checked, the last active scene is replayed.

Play in priority

By checking this option in the "Triggers" tab, the selected scene plays continuously until its end, without taking into account other triggers, except for time triggers and physical buttons on the device.

Time triggers

Select a scene from the list and assign it a trigger period. Organize and repeat triggers over the year in specific ways.

Single trigger

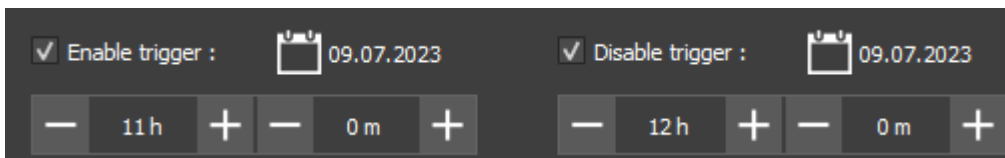

Check "Enable trigger" and "disable trigger" to determine a period. Select a date (timetable icon) and time (hour/minutes fields) of trigger activation and then disable trigger.

Without shutdown, the scene will play indefinitely until another event replaces it with another scene triggering or manual shutdown.

Permanent trigger

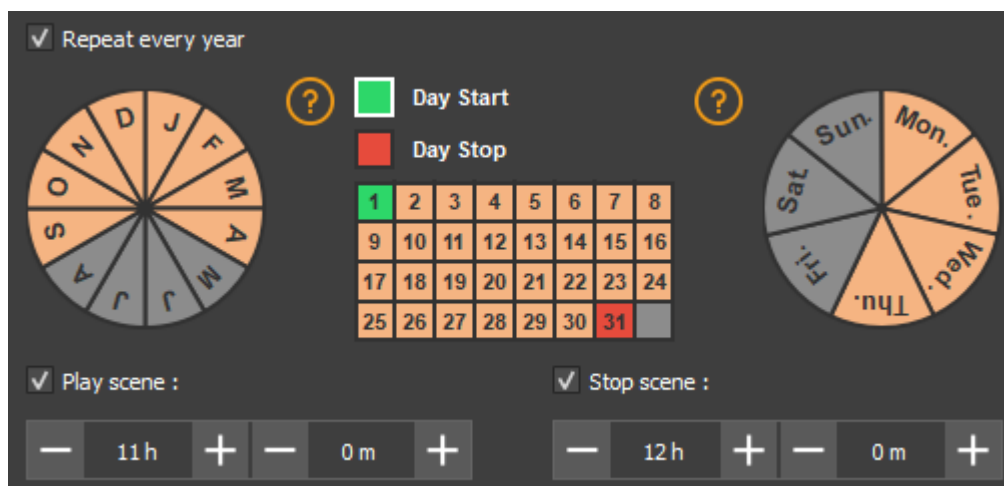

For example above: the scene plays from Monday to Thursday from 11 am to noon from 1st to 20 of each month, from September to April.

Check "Repeat every year" to set the monthly and then daily triggers.

Select or deselect the months of active triggers in the left wheel. (selection in orange)

After selecting the green square for the start day or the red square for the end day, determine the period of the month during which the trigger will be active.

Select or deselect the days of the week or the trigger will be active in the right wheel. (selection in orange)

Select a start time and an end time of trigger.

Note: For a daily repetition, if the start time is after the end time, the trigger will stop the next day, even if the next day has not been selected.

Light intensity trigger

This option is available for devices with an Infrared kit.

Cf. "Use the remote control"



Check "brightness" to activate or disable the trigger according to the ambient light. Once checked this option cancels and replaces the time trigger.

 Click on the icon to determine if the trigger activates or disables during the upward phase (day to night) or downward phase (night to day).

 Click the arrow to set a value that corresponds to the light sensitivity and at which the trigger activates or disables.

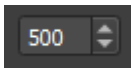
 Using the arrows, adjust the value that fits into the dedicated field.

Priority of hourly trigger

When multiple scenes have the same time trigger (date + hour + minute), only the last scene in the list will be triggered. The others will be ignored when triggering.

Save in memory option

Check scenes that need to be saved in memory.

	Name	Duration	Properties	Triggers	Zone
1	<input checked="" type="checkbox"/> Scene 1	00m 14s 400	00:05:000 #00		A
2	<input checked="" type="checkbox"/> Scene 3	00m 00s 480	00:03:000 #00		A
3	<input checked="" type="checkbox"/> Scene 4	00m 05s 720	00:05:000 #1		A
4	<input type="checkbox"/> Scene 5	00m 18s 000	00:07:000 #1		A
5	<input type="checkbox"/> Scene 6	00m 05s 000	00:00:000 #00		A
6	<input checked="" type="checkbox"/> Scene 6_copy_1	00m 05s 000	00:00:000 #00		A
7	<input type="checkbox"/> Scene 6_copy_2	00m 07s 000	00:00:000 #00		A
8	<input type="checkbox"/> Scene 6_copy_3	00m 07s 000	00:00:000 #00		A
9	<input type="checkbox"/> Scene 6_copy_4	00m 07s 000	00:00:000 #00		A
10	<input type="checkbox"/> Scene 6_copy_5	00m 07s 000	00:00:000 #00		A
11	<input type="checkbox"/> Scene 6_copy_6	00m 07s 000	00:00:000 #00		A
12	<input type="checkbox"/> Scene 6_copy_7	00m 07s 000	00:00:000 #00		A
13	<input type="checkbox"/> Scene 6_copy_8	00m 07s 000	00:00:000 #00		A
14	<input type="checkbox"/> Scene 6_copy_9	00m 07s 000	00:00:000 #00		A
15	<input type="checkbox"/> Scene 16	00m 03s 000	00:05:000 #3		A
16	<input type="checkbox"/> Scene 17	00m 08s 000	00:00:000 #2		A
17	<input type="checkbox"/> Scene 18	00m 03s 200	00:00:000 #40		A
18	<input type="checkbox"/> Scene 19	00m 13s 000	00:00:000 #2		A
19	<input type="checkbox"/> Scene 20	00m 04s 000	00:00:000 #2		A
20	<input type="checkbox"/> Scene 21	00m 03s 500	00:00:000 #2		A

Click on the "Write in Memory" button

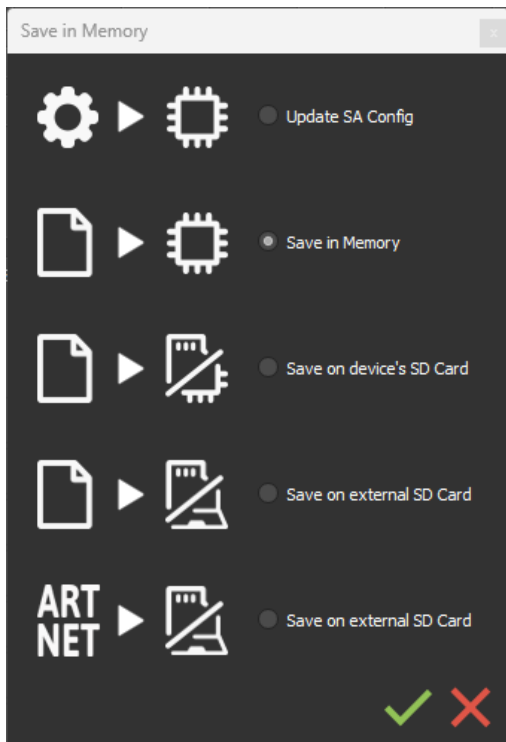

Select the desired option in the Scenes Write window.

Basic backup

Write standalone configuration: Change only certain settings in the configuration of a show

already written in memory. Reduces backup time.

Write to Memory: Default backup in the internal memory of the device.

Save to an internal and external micro SD card

For devices with a micro SD port.

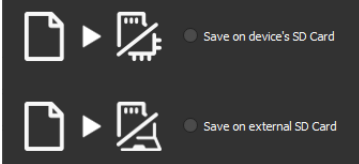

Save scenes to a micro SD card (Class 10) installed in the device's SD card reader or in the computer drive. The card must be CLASS 10, formatted in FAT or FAT 32 with a maximum capacity of 256 GB. It is recommended to use the largest allocation unit size available when formatting.

Write to the SD card of the device: SD card installed in the device drive

Write to an external SD card: SD card connected to the computer

Note: Save to the root directory of the SD card.

Backing up Art-Net or sACN to an external SD card

For devices with a micro SD port and an Ethernet port.

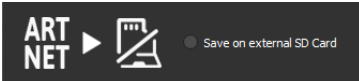

Art-Net - Write to an external SD card: Save up to 8 universes only on micro SD to render an Art-Net or sACN show independently.

Set the universe range in the IN/OUT config tab.

Pre-commissioning verification:

Connecting the RJ45 cable before power on.

Connection to the local network. Cf. "Ether Ethernet connection and configuration"

Configuring the device in Art-net or sACN mode via the software or DeviceTool.

Note: Once in Art-Net (Ar) or sACN (AC) mode, the device is no longer visible on the local network.

In Art-Net the device will use Broadcast to play the show on the network.

In sACN the device will use the Multicast to play the show on the network.

Standalone use

Switch to stand-alone mode

The device switches to standalone mode automatically after 5 seconds after power on and if no software connection is made.

External and USB power supply

The external power supply is only used for "Autonomous" mode. But it is possible to connect a USB cable and power supply at the same time, even if this configuration is not recommended. If a USB cable is connected to the device when running in standalone mode, the device will detect a possible connection to a computer but this will not affect the scenes that play.

Charging the clock battery

Before installing the device in standalone mode, connect it for 1 hour to charge the clock battery and avoid losing the saved time configurations.

Play a show via a Micro SD Card

To play the SD show standalone, insert the card into the micro SD drive of the device. When powered, the screen displays "Sd" to indicate that the SD file of the project is being played.

Note: The show file must be saved to the root directory of the micro SD. It will not be read if the file is renamed or saved in a folder or subdirectory.

Notes on Recommended Specifications for SD cards:

The class of the SD card indicates its read/write speed. Higher class numbers (for example, Class 10) offer faster speed and better compatibility.

Class 6 or higher micro SD cards are preferable for optimal system performance. Older Class 2 and 4 SD cards may not work.

Prefer Class 10 micro SD cards for mobile phones.

How to use IR Remote

Infrared Remote triggers work in standalone and in Live mode when "Get standalone Triggers" is checked in software option window, at the bottom of "Device" section. Get Stand Alone triggers

Previous Remote Control Unit (Before 2022)

Functioning for devices without Mode and older devices.

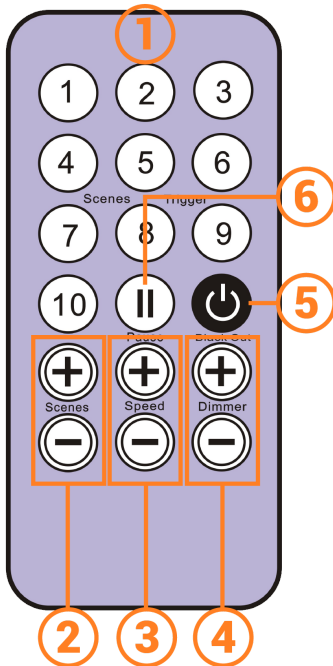

1. **Scene trigger buttons** (1 to 10) assigned via the software.
2. **Scene selector**, next or previous.
3. **Speed value**, increase & decrease
4. **Dimmer value**, increase & decrease
5. **Blackout**: Stops the current scene and plays the scene 00. All DMX levels are set to zero.
6. **Pause**: Freezes the current scene in its state

Functioning for devices with Modes

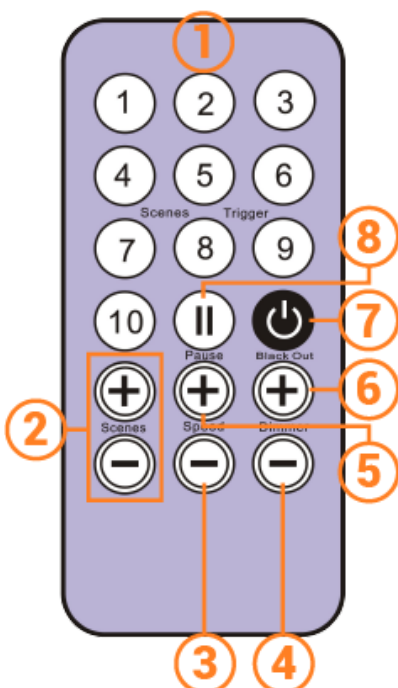

1. **Scene trigger buttons** (1 to 10) assigned via the software
2. **Increase or decrease** the value of the selected mode:
Scene +/-, Dimmer +/-, Speed +/-, Color +/-.
3. **Color mode**
4. **Scene mode**
5. **Dimmer mode**
6. **Speed mode**
7. **Blackout**: Stops the current scene and plays the scene 00.
All DMX levels are set to zero.
8. **Pause**: Freezes the current scene in its state.

New Remote Control Unit (2022)

Functioning for devices without Mode and older devices.



1. **Scene trigger buttons** (1 to 10) assigned via the software.
2. **Scene selector**, next or previous.
3. **Speed value** decrease
4. **Speed value** increase
5. **Dimmer value** decrease
6. **Dimmer value** increase
7. **Blackout**: Stops the current scene and plays the scene 00. All DMX levels are set to zero.
8. **Pause**: Freezes the current scene in its state

Functioning for devices with Modes



1. **Scene trigger buttons** (1 to 15) assigned via the software Trigger 1 to 15 with 1 Zone. Trigger 1 to 9 with several Zone.
2. **5 Control Zones** available: A, B, C, D, E and Global Zone: [] to trigger each Zone in the same time.
3. **Increase or decrease** the value of the selected mode: Scene +/-, Dimmer +/-, Speed +/-, Colour +/-.
4. **Release Colour mode**
5. **Colour mode**
6. **Scene mode**
7. **Dimmer mode**
8. **Speed mode**
9. **Blackout**: Stops the current scene and plays the scene 00. All DMX levels are set to zero.
10. **Pause**: Freezes the current scene in its state.

Functions descriptions

Scene +/-: Each push selects the next or previous scene of the current Zone. Scene are play immediately.

Master Dimmer: Increases or decreases the RGB, CMY and dimmer channels of the current zone. The CMY, RGB, Dimmer channels are defined in the Profile of the fixture and the stand-alone mode.

Scene Speed: Increases or decreases the speed of the current scene in the current zone. A different speed can be chosen separately for each scene.

Zones: Choose a Zone (A,B,C,D,E or Global []). Then select a scene or mode to trig in the selected zone.

Modes: Select a Mode from Speed, Dimmer, Colour or Scenes, then use +/- to change values.

IR Codes



IR receiver box

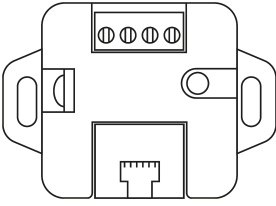

To use the optional IR remote control, an external circuit with an IR receiver must be connected via an RJ45 port or via the standalone device terminal block.

IR PCB pinout

-With RJ45 cable, use pins: #8 = Ground; #4 = IR data; #7 = 5V.

-With connectors, use pins: O = IR data; V = 5V; G = Ground.

Maximum distance from cable to receiver is approx. 20 m.

Light sensor

The light sensor integrated in the IR box circuit only works with hourly triggers. The external card must be connected via the RJ45 port or via the terminal block. Light sensitivity must be set in the software.

See "Time-controlled scenes".

NODE mode configurations

Setup with the software

Network setup

Access the device options window:



In the "Ethernet" tab, check "DHCP" to put the device in DHCP mode and apply.

To put the device in static IP mode, uncheck "DHCP" and enter the IP address, subnet mask, gateway, and name, and then apply.

Cf: "Ether Ethernet connection and configuration"

NODE Art-Net or sACN mode

The device's Node mode makes it possible to convert Art-Net and sACN signals to DMX.

In the Node part, select Node Art-Net to change the settings you want.

Configure names with "Short Name" and "Long Name".

Change the DMX ports or outputs of the Node by changing the "SubNet" and "DMX Universe", and then apply.

Select Node sACN to choose DMX and applied Universes.

The screenshot shows the "Ethernet" configuration window. Under "Configuration réseau", the "DHCP" checkbox is unchecked. The IP address is set to 2.0.0.11, the Masque to 255.0.0.0, and the Passerelle to 2.0.0.1. The Nom is DMX_Ethernet_Interface. Under "Node", the Mode is set to ArtNet. The Short Name is CLUB-E1024 - A0123 and the Long Name is CLUB-E1024 - A0123 - 15.0.1.0. The SubNet is 0x00. The Univers DMX are set to 0x00 and 0x01. There is an "Appliquer" button and a "Reboot" button at the bottom.

The screenshot shows the "Ethernet" configuration window. Under "Configuration réseau", the "DHCP" checkbox is checked. The IP address is set to 000.000.000.000, the Masque to 000.000.000.000, and the Passerelle to 000.000.000.000. The Nom is empty. Under "Node", the Mode is set to sACN. The Univers DMX are set to 1 and 2. There is an "Appliquer" button and a "Reboot" button at the bottom.

Press "Apply" to take into account the new settings.

To use the device in the selected mode, you must restart the device after configuration by unplugging it from the power supply.

It is also possible to switch between Art-Net and sACN mode with long support (5s.) on the Device Mode button and following the network configuration of the device.

Setup with the DeviceTool

Network setup

Open the device via USB or Ethernet with the option "Open USB Device" or Open "Ethernet Device". Select the "Network" tab.

In the "Ethernet" tab, check "DHCP" to put the device in "DHCP" mode and apply.

To put the device in static IP mode, uncheck DHCP and enter the IP address, subnet mask, gateway, and name, then apply.

The screenshot shows a dark-themed network configuration window. At the top, there are five tabs: "Network", "Mode", "Date / Time", "Upgrade", and "Firmware". The "Network" tab is active. Below the tabs, there is a "DHCP" checkbox which is checked. To the right of the checkbox, the IP address is set to "192.168.0.5". Below the IP address, there are two input fields: "Mask" with the value "255.255.255.0" and "Gateway" with the value "192.168.0.1". Below these fields is an orange "Apply" button. At the bottom of the window, there is a "Name" label followed by a text input field containing "Node-2". Below the name field is another orange "Apply" button.

NODE Art-Net or sACN mode

The device's Node mode makes it possible to convert Art-Net and sACN signals to DMX.

Open the device via USB or Ethernet with the option "Open USB Device" or Open "Ethernet Device". Select the "Fashion" tab.

Select Node Art-Net to change the desired settings.

Configure names with "Short Name" and "Long Name".

Change the DMX ports or outputs of the Node by changing the "SubNet" and "DMX Universe", and then apply.

Select Node sACN to choose DMX and applied Universes.

Press "Apply" to take into account the new settings.

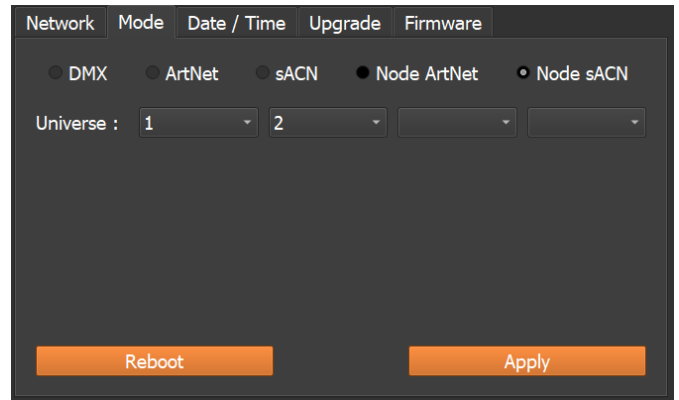
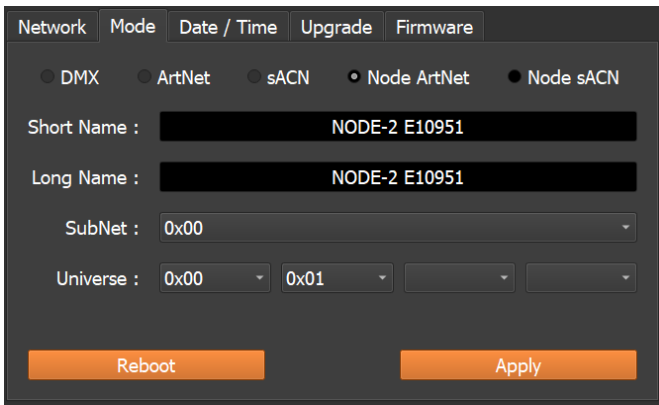

To use the device in the selected mode, you must restart the device after configuration by unplugging it from the power supply.

Switch between Art-Net and sACN mode with long support (5s.) on the Device Mode button and following the network configuration of the device.

Configuration with a Web Browser

This feature is not currently available.

Udp, Broadcast, Unicast, Multicast

Art-Net and sACN are communication protocols based on the UDP/IP standard. These 2 protocols integrate DMX frames into Ethernet frames allowing simpler and more convenient wiring with the use of IP switches or WIFI terminals.

Several DMX lines can be encapsulated in an Ethernet frame and therefore reduce wiring to 1 single Ethernet line for X DMX lines.

Art-Net network data is transmitted in Broadcast or Unicast. Unicast is preferable when using multiple devices on the network and when managing more than 10 DMX universes.

sACN network data is transmitted in Unicast and Multicast.

NODE wiring diagram

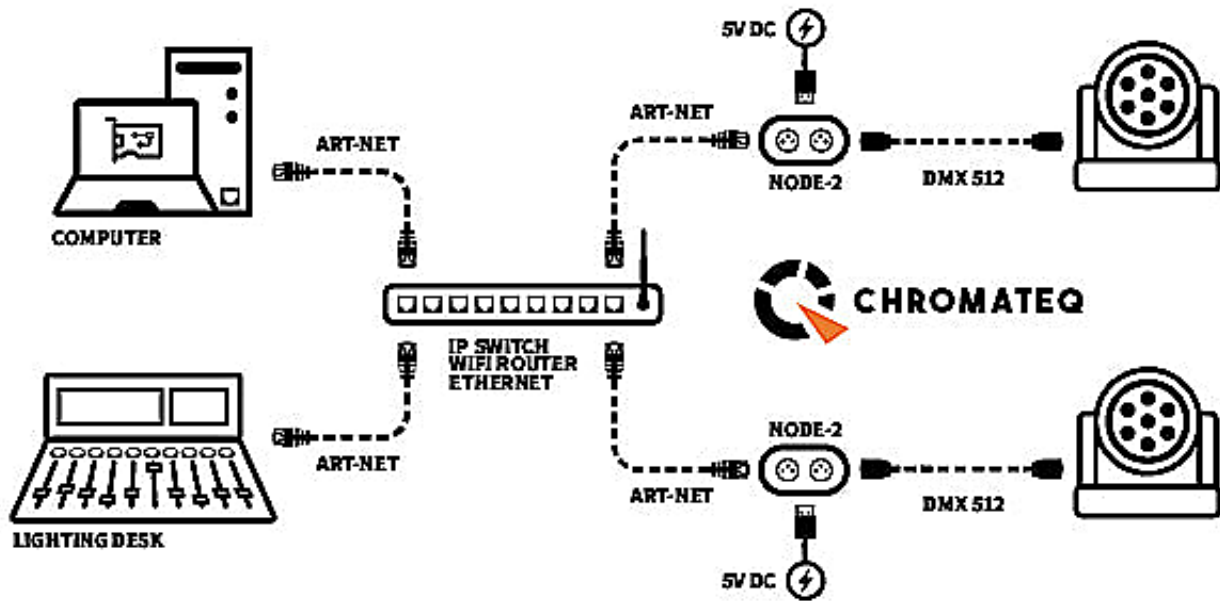

Reset default device

To restore the default values and reset your device, reconfigure the device via USB or Ethernet with the software or DEVICETOOL or app and restart it to take into account the new mode and settings.

Change mode directly on the device with a 5 second long press on the mode button.

Network NODEs detection

Connect multiple devices into the same network to multiply the output DMX universes.

Check previous steps

- Assigning IP addresses and subnet masks.
- Configuring devices via the software or DeviceTool.
- Connecting devices to the network.
- Powering devices.

If the steps have been followed, the devices are visible on the network by the software or by other devices compatible with Art-Net frames.

Options

Network Interface : Ethernet 2 : 2.0.0.10

Output Input

Refresh + X Edit

Power

NODE-2 10973
NODE-2 01234
NODE-2 10974

Node

Short Name : NODE-2 01234

Long Name : NODE-2 01234

IP Address : 2.0.0.11

SubNet : 0x00

Port : #1 [U 0x00 : DMX Universe 1]

Software Universe : DMX Universe 1

Options

Period : 25 ms / 40 Hz

- Broadcast ArtNet packets
- Send manufacturer frames
- Keep Node configuration

↩ ✓ ✗

Dimensions

Dimensions in mm.

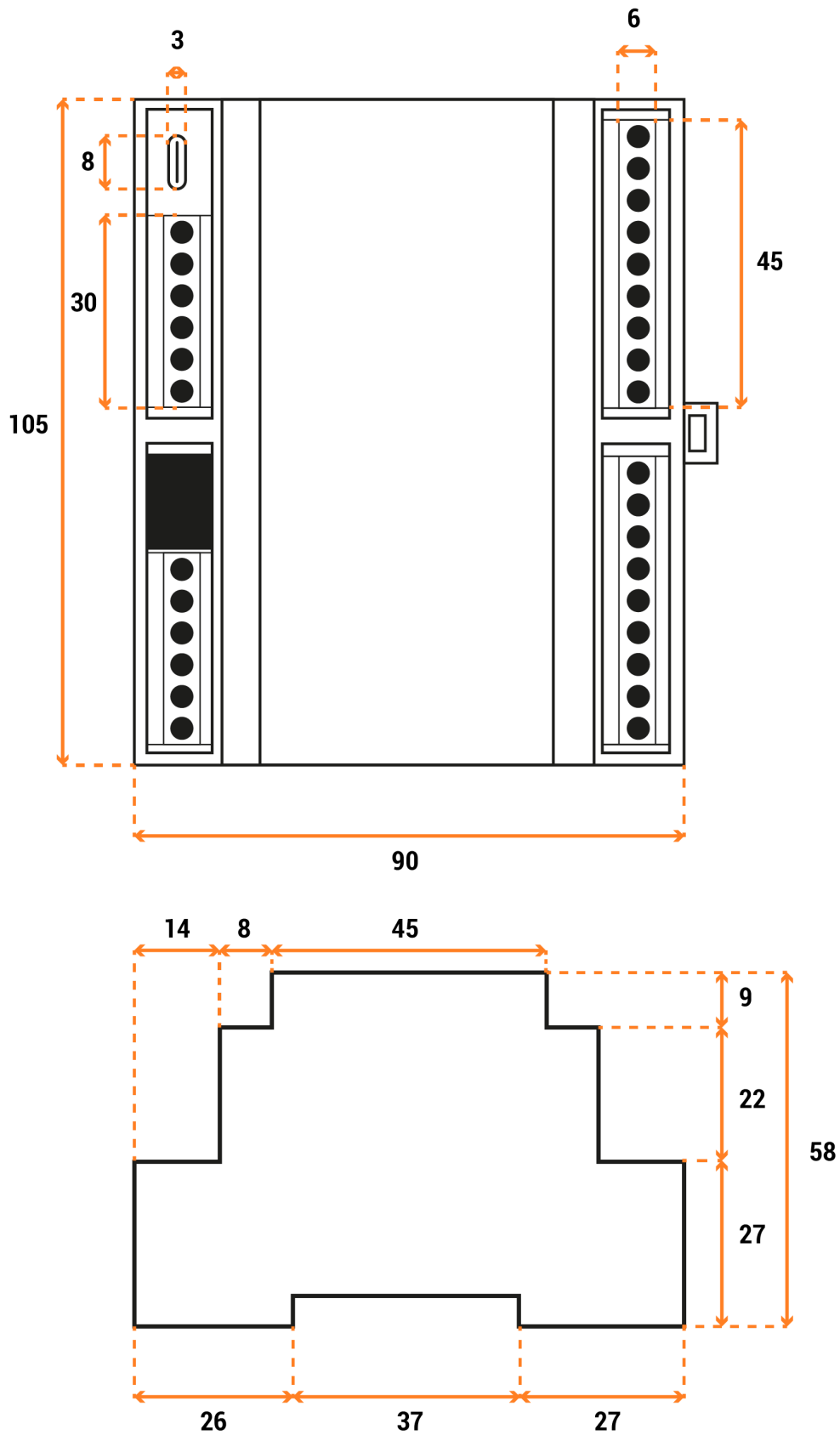

Wiring Diagram

General wiring diagram

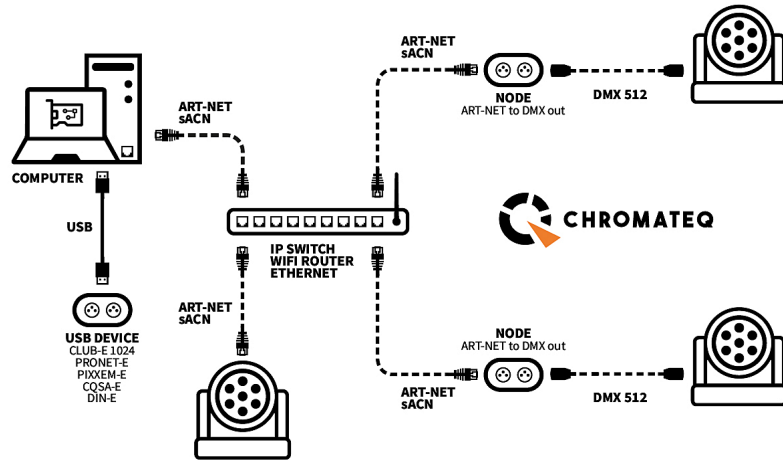

Standalone Art-Net wiring diagram

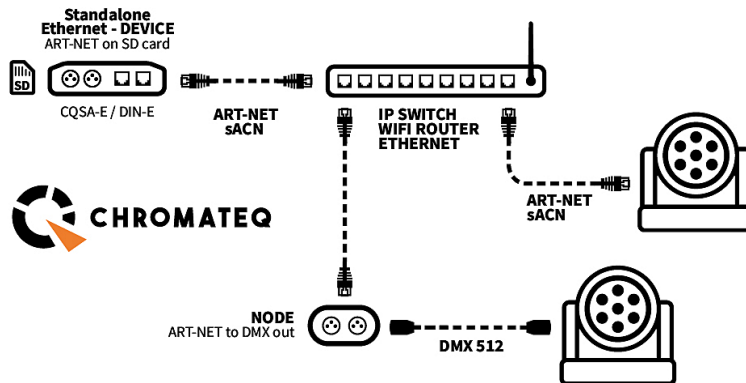

Master/Slave Standalone wiring diagram

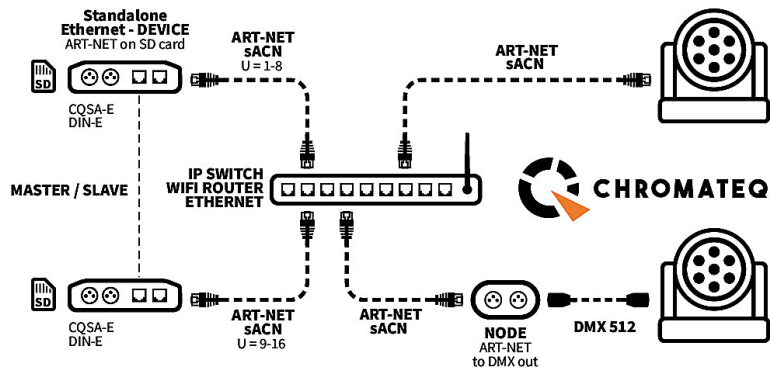

Troubleshooting

The device is not detected by the DeviceTool or USB software.	<p>Unplug to restart the device.</p> <p>Change the USB cable</p>
The device is not detected by the DeviceTool or Ethernet software.	<p>Unplug to restart the device.</p> <p>Change the Ethernet cable</p> <p>Check the selection of the Ethernet network before opening.</p>
The device is not detected on the network.	<p>Check the mode of communication with LED signals and reconfigure the device via USB if necessary</p> <p>Verify that the IP addresses and subnet mask are configured correctly.</p> <p>Update the firmware of the device via the software or DeviceTool</p> <p>Update the software with the latest version and try again</p> <p>Open and allow communication ports used by the device. Some local networks may require manual opening of the following UDP Ports: 8011 + 8012 for communication between the device and software.</p>
The device is blocked in standalone mode and it cannot establish communication with the software.	<p>Check the firmware and software version.</p> <p>Device with display When working properly: The screen indicates "ON" when connected to the computer, then it displays "SA" and "00" (or a scene number). When you start the software and the device is properly detected, you should see "PC".</p> <p>Device without display Check the mode of communication with LED signals.</p> <p>During the 5 seconds before the device switches to standalone mode:</p> <ol style="list-style-type: none"> 1) Create a small show with a scene (in demo mode) and close the software after saving the show.(optional) 2) Unplug the device. 3) Start the software and wait for the software to be on the 1st page of the wizard with the

	<p>selected USB device.</p> <p>4) Plug in the device and start the software IMMEDIATELY. Simply confirm all the steps of the wizard. You should see the device well detected and listed in the wizard.</p> <p>5) Open the software and quickly write the small show in memory.</p> <p>Writing a new scene cleanses memory and does not allow the infinite loop to reproduce.</p>
<p>The device does not restore the Art-Net or sACN show.</p>	<p>Before commissioning, plug the RJ45 cable before powering.</p>
	<p>Replugging the power supply</p>
	<p>Insert the SD card again (Reset)</p>
	<p>Device with display Select ArtNet (Ar) mode again, sACN (AC) in the advanced F3 menus of the device (mode button).</p> <p>Device without display Select ArtNet, sACN mode again via the software or DeviceTool.</p>

If you experience unlisted issues, contact your seller or manufacturer directly to indicate your problem and receive a solution.

Product design and specifications are subject to change without prior notice.

Older devices (sold before 2020) are not compatible with PRO DMX version 2



191 Allée de Lauzard
34980 St Gély du Fesc, FRANCE
Web: www.chromateq.com
Email: info@chromateq.com
Phone: +33 952210755

Wechat: Chromateq
WhatsApp: +8613422062209
QQ: 2908265661



Guaranteed products: 1-3-5 years
Software pack: <https://chromateq.com/dmx-software-downloads/>

Copyright © 2021 - CHROMATEQ. All rights reserved.