



Congratulations on your purchase of a CHROMATEQ controller.

Please read this manual carefully and thoroughly before using Chromateq CQSA-E 1024 / PRO.

The information presented here provides a useful introduction to the wide range of features, settings and functions available in this compact and versatile device.

This CQSA-E Technical Manual is written in English and French.
(Le manuel technique du CQSA-E est rédigé en anglais et en français.)

All products and software are developed and designed in France.

CHROMATEQ SARL
191 Allée de Lauzard
34980 St Gély du Fesc
FRANCE
VAT: FR18521458034
Siret: 52145803400027

Web & E-mail: www.chromateq.com
Phone: +33 952210755 / +86 13422062209

Whatsapp: +8613422062209
Wechat: Chromateq
QQ: 2908265661

Twitter: <https://twitter.com/Chromateq>
Facebook: <https://www.facebook.com/ChromateqCompany/>
YouTube: <https://www.youtube.com/c/chromateq>

Copyright Information and Disclaimer

Copyright © 2021 – CHROMATEQ. All rights reserved.

No part of this publication may be reproduced, distributed, or transmitted in any form or by any means, including photocopying, recording, or other electronic or mechanical methods, without the prior written permission of the publisher, except in the case of brief quotations embodied in critical reviews and certain other none commercial uses permitted by copyright law.

For permission requests, write to the publisher, addressed "Attention: Permissions Coordinator," at the address above.

Trademark Credits

Microsoft and Windows are U.S. registered trademarks of Microsoft Corporation. Art-Net™ – Designed by and Copyright Artistic License Holdings Ltd. All other products mentioned herein may be trademarks of their respective ® companies.

Package Contents

1x CQSA-E
1x USB cable
1x Power supply 9-12V DC (Euro/US plug)
1x download link for software and technical documentation

Please note: Check the package contents and the condition of the interface after unpacking! Contact your supplier if something is missing or damaged. Do not use the device if it seems to be damaged!

SUMMARY

SUMMARY	3
INTRODUCTION.....	4
TECHNICAL SPECIFICATIONS	4
DEVICE FEATURES	4
SOFTWARE OPTIONS	5
BUTTONS AND CONNECTIVITY	5
Front and Side Panels	5
Rear Panel	5
BUTTON OPERATION AND LED DISPLAY MENU	6
Available Modes and option descriptions	6
LED Display Menu Key	7
Advanced device configuration.....	7
Clock and calendar setting.....	8
Clock Calibration.....	8
USB CONNECTION (DRIVERS + CONNECTION).....	8
Multiple USB connections.....	9
ETHERNET CONNECTION AND IP SETTINGS	9
1st connection on LAN (DHCP or Static IP).....	9
IP configuration and settings (Reset IP address).....	10
Installation diagram.....	10
Remote control via internet.....	10
Troubleshooting	10
CONNECTING TO DMX ETHERNET DEVICES VIA WIFI ROUTER	11
STAND ALONE CONFIGURATION AND SETTINGS.....	12
Save scene in memory.....	12
Configuration options	12
STAND ALONE OPERATION.....	13
Reverting to Stand Alone mode.....	13
External Power supply and USB.....	13
Battery charging	13
Micro SD Card.....	13
Choosing Stand Alone modes.....	14
TRIGGER CONFIGURATION	15
Buttons	15
Clock and calendar	15
Dry contact	16
Contact commands.....	17
Wi-Light 2 App and UDP	17
Infrared	18
Light Sensor	18
DMX in.....	19
OTHER ADVANCED TRIGGER OPTIONS	20
Scene recovery after power off	20
Time Trigger Priority.....	20
Play in Priority	20
ZONE SETTINGS AND CONFIGURATION.....	20
Editor mode	21
Standalone Mode.....	21
MASTER/SLAVE SETTINGS AND CONFIGURATION	22
Configuring Master/Slave interfaces	22
Ethernet Master / Slave	23
ART-NET and sACN SETTINGS AND CONFIGURATION.....	23
Recording Art-Net or sACN shows to memory	23
NODE SETTING AND CONFIGURATION.....	24
NODE configuration from software	24
DMX MERGE CONFIGURATION.....	24
PHYSICAL DIMENSIONS	25

INTRODUCTION

The CQSA-E is a versatile multifunction lighting control interface.

- Suitable for live applications and fixed installations
- Hardware compatibility with Player, Pro, Pixel Mapping and Studio DMX software
- Remote device configuration and lighting control when connected to an access point or Wifi router
- Playback over Ethernet without a computer when operating in Stand Alone mode
- SD card slot provides option to expand memory capacity
- Art-Net, sACN Playback on Ethernet
- DMX Splitter mode boosts reliability of DMX networks
- Wide choice of triggering methods
- Wi Light 2 app web remote compatible over Ethernet and Internet

TECHNICAL SPECIFICATIONS

Input	USB 2.0 via Mini USB and Ethernet via RJ3 connector
Number of DMX Outputs	Up to 1024 on 3 pin XLR (XLR5 optional)
DMX Modes	2x512 ,1024 or 512 in/out (PC + Stand Alone)
Internal Memory	Yes, 4Mb (no SD card required)
External Memory	SD card slot (accepts all FAT format, Class 10 SD, up to 256 GB)
Memory Capacity	20000 steps with 16 ch., 6000 steps with 512 ch., 3000 steps with 1024 ch.
CPU	32-bit processor
Dimensions	H: 38mm(1.49in) / W: 166mm(6.54in) / D: 97mm (3.82in)
Net Weight (interface)	0.2 Kgs (0.44 lbs.)
Gross weight (package)	0.41 Kgs (0.9 lbs.)
Power Input	5V to 24V DC, 0.5A max on DC connectors, 5V, 0.5A via USB
High Voltage Protection	Yes
Housing	Black with 4 mounting slots, ABS Plastic
IP rating	IP40
Power / Consumption	0.3 ~ 0.5 W
Operating environment	Indoor
Storage	Keep dry
Operating Temperature	- 25 to +70 C°
Certifications	CE, RoHS
International Warranty	Yes, 5 years
System Compatibility	Windows (7 and +), MAC OS X (10.13 and higher, 64 Bits) and Linux (64 Bits, Debian, Redhat, Archlinux, Raspberry Pi)

DEVICE FEATURES

DMX Input	PC and Stand-Alone mode, DMX record, DMX trigger
Stand Alone Mode	2x512 (splitter), 1024, 512 in/out, fine DMX channels (16 bits)
Art-Net, sACN	Yes, PC and Stand Alone (SD card)
NODE	Art-Net to DMX decoder for 2x512 channels (2 DMX universes)
Multiple Zone	5 Zones, play up to 5 scenes concurrently
Stand Alone DMX Merging	Yes, merge DMX lines and interfaces to play different Zones together
Real Time Clock - RTC	Time and calendar triggers (minutes, hours, week, days, month)
Trigger buttons	8 buttons with blue LED status display
Menu Buttons	4 buttons (Mode, Confirm, plus, minus)
Mode Menu	Scene and Page selection, Speed, Master Dimmer, Custom colours
RJ45 I/O	2x RJ45 connectors for all In/Out pins and connections
Dry Contact Triggers	7 contacts port on 3,3V or 5V
Infra-red Receiver	External IR PCB and IR remote control available (optional)
Infra-red Options	10 scene selection, scene speed, master dimmer and next scene

Light intensity Triggers
 UDP communication
 Master/Slave
 Compatibility
 Wi Light APP WEB Remote

External PCB with light sensor available (optional)
 Ethernet protocol (UDP) with a list of possible commands for CQSA-E
 Link up to 32 units by wired RJ45 connection or up to 128 units by Ethernet
 8- and 16-bit DMX fixtures
 Yes, Stand Alone option, need to create a user account

SOFTWARE OPTIONS

Player Software	1024 channels DMX + Stand Alone mode, Live Board mode
Studio DMX 3D viewer	Full Mode
Pro Software	1024 channels, normal mode, 30-minute loop of Audio and Video Timeline
Art-Net output from PC	2 Universes (DMX + Artnet)
Wi-Light 2 App	Control Player, Pro or Pixel Mapping software over Ethernet local WiFi network and via Internet
Free updates and download	Yes

BUTTONS AND CONNECTIVITY

Front and Side Panels

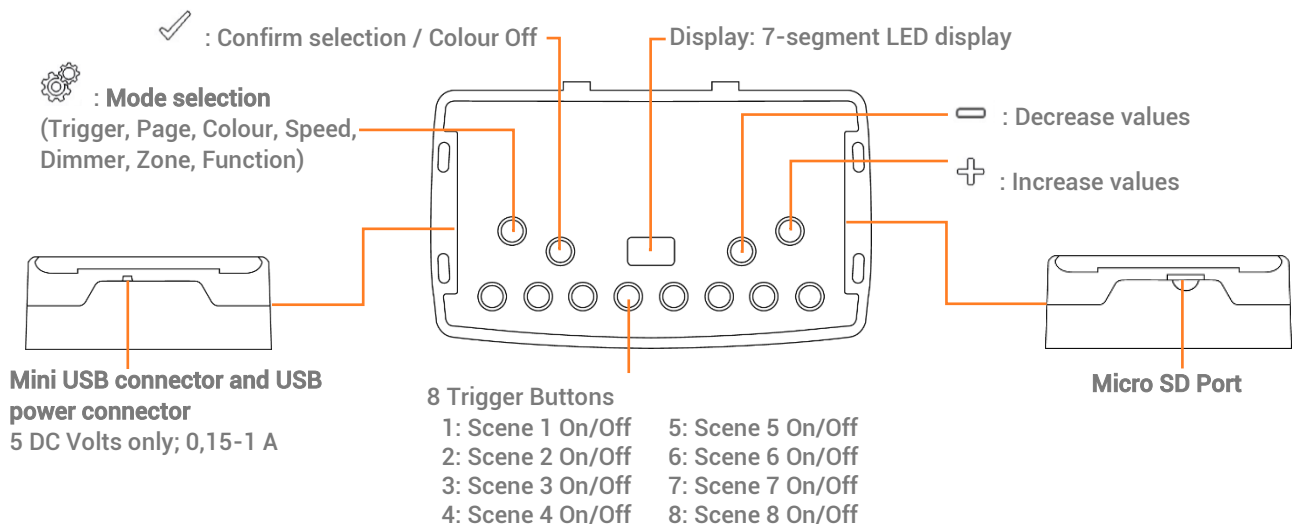

Rear Panel

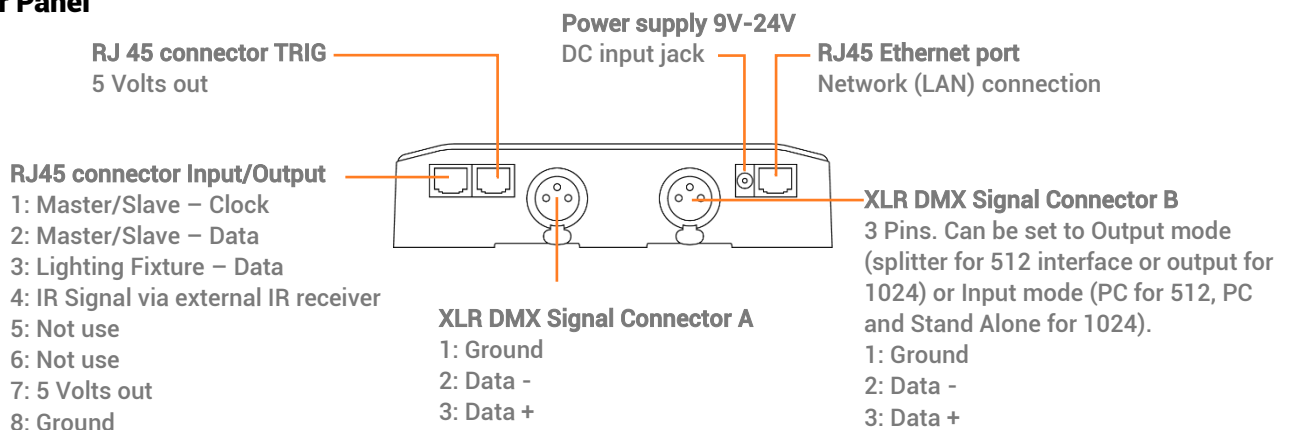

BUTTON OPERATION AND LED DISPLAY MENU

Mode selection button

Press the  button to select one of the available modes: Scene triggers (SA), Page (PA), Colour (Co), Speed (SP), Dimmer mode (dl) or zone selection (Zo).

Press and hold the  button for 4 seconds to enter the advanced function mode.

Confirm Button

Press the  button in SA, ArtNet, sACN, Node mode to display the current network mode (Static IP or DHCP).

When navigating Mode menu, press the  button to confirm values or to release the current colour selection.

Next/Previous (Up/Down) +/- buttons

Press + or – buttons to navigate the Mode menu or change values or use the colour wheel.

Blue LED buttons

In SA Scene or Page mode, push one of the 8 trigger buttons to play a scene from memory.

Push the button again to stop the scene.

In Colour mode, push a trigger button to select (start) a custom colour. Push again to stop.

Available Modes and option descriptions

Scene trigger mode "SA": Select the desired scene using the + or – buttons, then press Confirm to play the selected scene (01 to 255). The scene number will flash several times to confirm your selection.

Scene "00" indicates that no scene is playing.

Page Mode "PA": Select the desired page using the + or – buttons (P0 to P9), then choose an available scene in the selected page using the 8 trigger buttons. Then the number of the selected scene will be display on the LED display.

Colour mode "Co": Using the 8 trigger buttons, select one of the 8 custom colours. Or, choose a colour from the colour wheel using the + or – buttons to select from 00 to 99. Press the Confirm button to turn off the current colour or to recall the last colour from the colour wheel.

Speed Mode "SP": Increase or decrease the Speed of the current scene using the + or – buttons.

Values range from -9 to +9.



Dimmer Mode "dl": Increase or decrease the general intensity (dimmer and/or RGB channels) of scenes and colours with + or – buttons. Values range from -9 to +9.

Zone Mode "Zo": Select the zone using the + or – buttons (Zone A ~ E and global Zone), then choose an available scene in the selected zone using the 8 trigger buttons or pages.

Advanced function Mode: Scroll through the functions F1 to F5 using the + or – buttons and press Confirm to enter the function.

LED Display Menu Key

The LED Display shows the current scene, zone, page, colour, operating mode, speed, dimmer and firmware version. The displayed values vary according to the selected mode.



On	-	The interface is powered On and is not running any show from memory.
PC	-	The interface is connected to a computer and communicating with the software. In this mode, the interface is under software control.
IP	-	The interface is in stand-alone and static IP mode. The default network address is 192.168.0.5.
Dh	-	The interface is in stand-alone and DHCP mode. The network address is automatically defined by the router or the access point.
Sd	-	Inserted SD card is properly detected and the interface is playing the show file from the Sd card.
SA	-	Scene trigger mode. In this mode, the LED display shows the current scene number (from 01 to 511). By default, when no scene is playing, all DMX channels are set to 0. "00" indicates Blackout and the interface sends nulls (0x00) on all DMX channels.
PA	-	Page mode. There are 10 pages of 8 scene, it is about 80 scenes maximum to be triggered. The display indicates the page number from P0 to P9. In this mode, use the 8 trigger buttons play the scenes stored in the selected page.
Co	-	Colour mode. The display indicates the selected custom colour number (from C1 to C8). Or the colour value applied from the colour wheel.
SP	-	Speed mode. Increase or decrease the current scene speed. The display indicates the speed of the current scene from -9 to 9.
dl	-	Dimmer mode. Increase or decrease light output of scenes and custom colours. The display indicates the general intensity from -9 to 9.
Pr	-	Programming memory Mode. Pr is displayed when the interface is writing a show to memory.
Zo	-	Zone mode. After programming the interface memory, Zone A is selected by default. In this mode, the LED display shows the current Zone: Global, A, B, C, D, E. Zone A to D display: 
		Global Zone display:  The display switches between the current zone and the running scene number every 3 seconds. Use + or - to navigate between zones. Scene buttons may be pressed to instantly trigger scenes without entering in the zone with the  button.
F1, F2, F3	-	Functions 1 ~ 5 of the advanced function mode.
No	-	Node mode (Art-Net to DMX decoder for x2 Universes)
Ar	-	Art-Net mode (Stand Alone, from SD card show file)
AC	-	sACN mode (Stand Alone)
YE	-	Year setting in the clock setting mode.
Mo	-	Month setting in the clock setting mode.
dA	-	Day setting in the clock setting mode.
ho	-	Hour setting in the clock setting mode.
Mi	-	Minute setting in the clock setting mode.
CL	-	Confirmation of the new clock setting.
bL	-	Updating firmware mode. Displayed when a new firmware is being written to memory. The display will flash during the firmware update. Do not disconnect the interface in this mode.
Fi	-	File Problem in the SD card: No show File save on the SD card or wrong File name (sdcardshowv2.sdq) or show file corrupted or empty SD Card detected or wrong memory format.

Advanced device configuration

The advanced function mode menu provides access to several global interface settings. Press and hold the  button for 4 seconds to enter this mode.

F1: Display the static IP of the interface. Press  to scroll through the numbers.

F2: Select DHCP (dh) or static IP (iP) mode. Press  to switch the current mode.

F3: Press  to enter the mode. Use the + and - buttons to select the Stand Alone (SA), Art-Net (Ar), sACN (AC) or Node (no) mode. Press  to confirm the selected mode. The interface will immediately reboot to run the new mode.

F4: Manual Clock Setting. Press  to enter this mode. (See Clock and calendar setting below).

F5: Display the interface firmware version. Press  to scroll through the numbers.

Clock and calendar setting

In Clock mode (advanced function menu F4) "YE" shows the current year setting.

Use the + and - buttons to select the correct year and confirm by pressing the ✓ button.

Repeat this procedure to set month (Mo), day (dA), hour (ho) and minutes (Mi).

After confirming the minutes, "CL" will blink to confirm that the new configuration is saved to memory.

The interface clock is now calibrated to your new setting.

This function is useful for setting the interface clock directly on site and without the use of a computer.

Clock Calibration

After several weeks or months of use, you may notice the internal clock running slightly fast or slow. The standalone mode in the software includes a clock calibration setting. The internal clock may also be calibrated using the Device Tool program. Use the calibration setting to compensate for the clock's timekeeping discrepancy by adding or subtracting milliseconds per day.

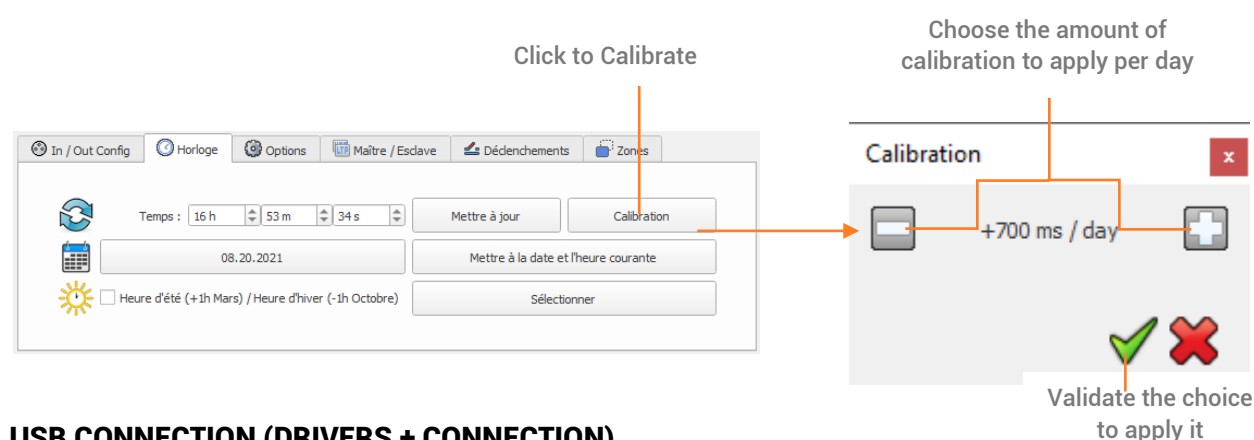

USB CONNECTION (DRIVERS + CONNECTION)

After installing the control software and the USB drivers, use the USB cable to connect the interface to the computer.

Windows drivers installation: Before opening the software for the first time, it is possible to check that the drivers were properly installed during the software installation:

Go to the device manager and check that this icon is visible under « Universal Serial Bus controllers»:

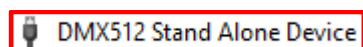

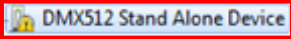
If there is a warning icon on the DMX512 Stand Alone Device  the drivers will require manual installation.

Mac and Linux drivers are automatically installed. In Mac OS, check the « USB device tree ».

In Linux, use the command « lsusb » to check if the « DMX 512 Stand Alone device » line is visible.

Once connected, start the software and select "USB". All connected interfaces will be detected and displayed in the list. Uncheck any interfaces that are not needed.

Multiple USB connections

Here is an example of system diagram using USB hub. Each connected interface needs its own USB port and connection. It is possible to connect up to 12 interfaces to a computer.

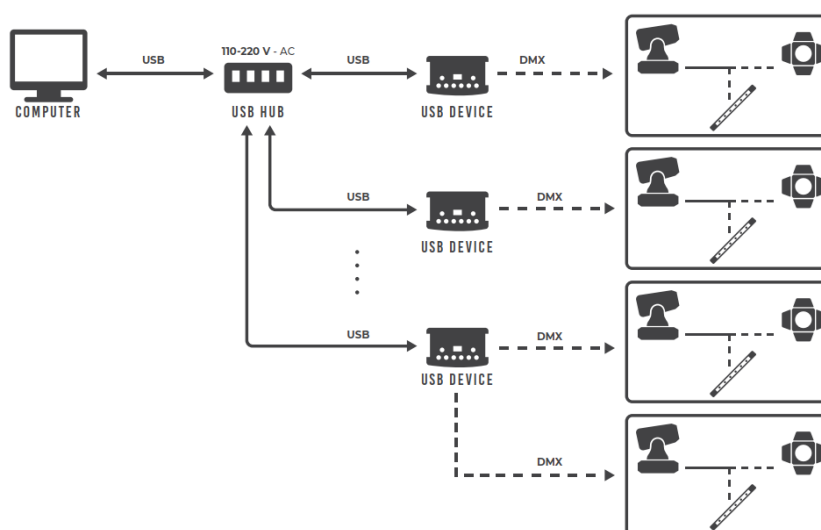

ETHERNET CONNECTION AND IP SETTINGS

Connect the interface to the local network (LAN or WLAN) via RJ45 cable attached to its Ethernet port (RJ3). Power the interface with DC input (5-24V) or via the USB cable (5V).

1st connection on LAN (DHCP or Static IP)

The default static IP address is 192.168.0.5 with subnet mask 255.255.255.0.

DHCP mode is used on local networks where a DHCP server or IP switch manages all connected device IP addresses. Static IP addresses are used on local networks without DHCP servers and when connecting directly to a computer (no access point, router or switch).

The interface is in Static IP mode by default and will be detected by the control software when running on a computer connected to the same network and same IP address range. If you want to communicate directly by Ethernet (no USB, no switch) you need to fix the IP address of your computer with the same range of IP address (192.168.0.x).

To configure the device for DHCP mode:

Press the Mode button for 4 seconds. Use the + and – buttons to select F2 mode, then select (dh) and press the Confirm button to set the interface to DHCP mode. The same procedure will return the interface to IP mode by selecting (iP).

Once the interface is connected to the LAN, start the software and select "Ethernet". All interfaces on the network will be detected and displayed in the list. Uncheck interfaces that are not needed.

In DHCP mode, if the interface does not receive a valid IP address from the DHCP server, the interface will default to its static IP address to establish the Ethernet communication and the interface display will show "iP" after a few seconds.

IP configuration and settings (Reset IP address)

In the software, follow this procedure to set the interface's network configuration:

Go to "Tools" and "Options" menu and select the "Device" tab.

In the "Ethernet" tab, click "DHCP" to set the interface to DHCP mode.

To choose a static IP address for the interface, uncheck DHCP and enter the desired IP address, subnet mask and gateway, then click "apply" to confirm your choice.

It is also possible to define the name for the interface that will be displayed on the network.

Installation diagram

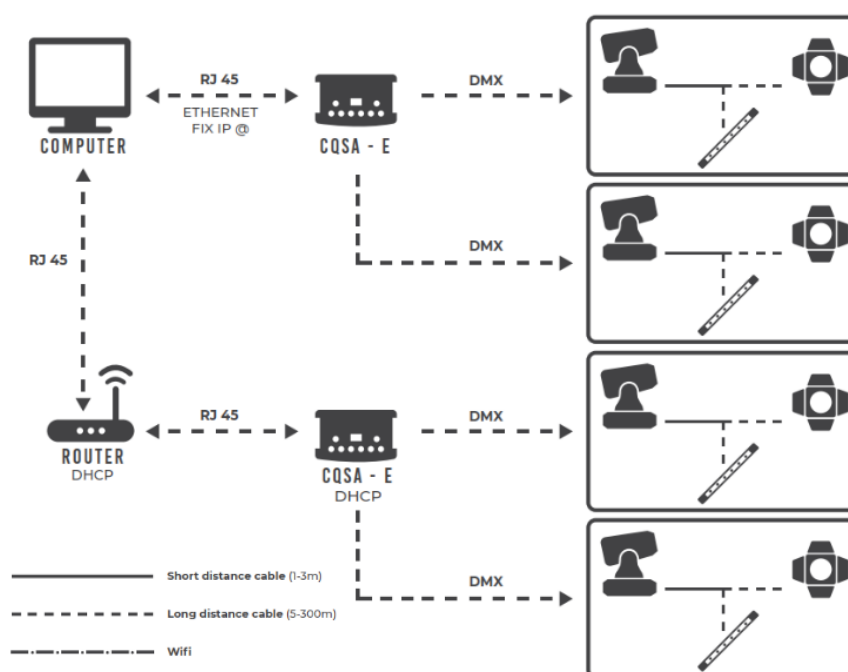

Remote control via internet

Interfaces with a serial number higher than 300 can be controlled from the internet.

To do this, they must be connected to a network with internet access. You must then refer to the Wi-Light 2 manual to create a user account and add your interfaces to your account when connected to a local network. For Live software control and maintenance over internet, there will be a future software release supporting this feature.

Troubleshooting

If you are unable to detect the interface, you should check the following network settings and tips:

- Connect the RJ45 network cable to the interface **before** turning it on (IP setting is done when power on).
- IP and subnet mask correctly configured to match the local network.
- Some local networks may require the following UDP ports to be opened manually:
 - 8011 + 8012 (communication between interfaces and software)
 - 8011 + 8014 (communication between interfaces)
 - 6454 (Art-Net communication)
 - 5568 (sACN communication)

CONNECTING TO DMX ETHERNET DEVICES VIA WIFI ROUTER

The RJ45 port on DMX Ethernet devices enables wired connection to a local area network, but it is also possible to wirelessly connect to the network by WiFi.

Illustrated below is an example configuration using a third-party mini WiFi router to enable a wireless connection. Other descriptions for such routers include "hotspot", "hub", "dongle", "bridge", "repeater", etc.

Note: This example shows a single DMX Ethernet device, but it is possible to connect multiple DMX Ethernet devices to the WiFi router using a third-party IP network switch to expand the available RJ45 ports.

Setting up the wireless network:

- Configure the WiFi router as a hotspot to create a new access point (or configure the WiFi router as a bridge or repeater to join an existing network). If IP addresses are assigned dynamically on the network by a DHCP server, refer to the WiFi router's datasheet/manual for details regarding configuration.
- Once the router is correctly configured, connect it to the RJ45 port of the DMX Ethernet device. Set the DMX Ethernet device configuration to DHCP or static IP mode (refer to the device's datasheet/manual for details).
- Once the DMX Ethernet device is connected to the router, it can be controlled by the Wi-Light 2 App.

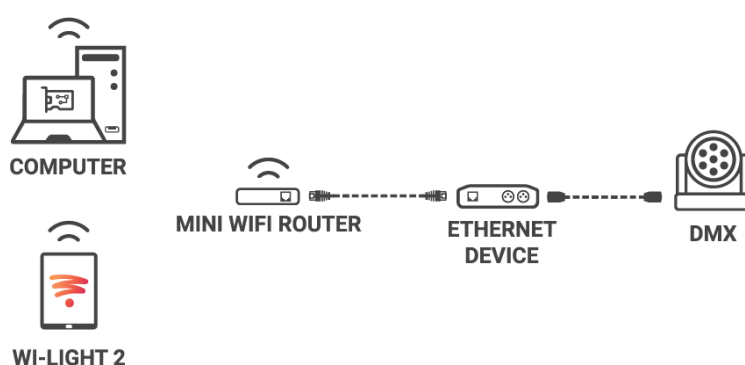

Example of mini WiFi dongle/router installation:



Never use the interface's 5v usb port to power another device.

STAND ALONE CONFIGURATION AND SETTINGS

Save scene in memory

In the Stand-Alone mode of the control software, drag and drop a scene from the open project's scene list to the list of scenes to be written to the interface's memory. Adding a trigger action (LED Button, Contact, IR remote, DMX In, Repeat Time and Start Time) will automatically transfer the selected scene into the list of scenes to be written into the memory.

Click to **Save in Memory** button and select the desired option (**Save in Memory** by default)

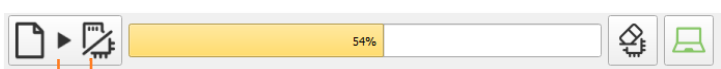

Save in memory

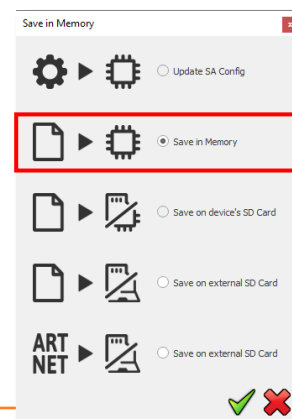

Configuration options

IN/OUT Config tab

Change the configuration of the interface's DMX I/O when using 2 DMX universe devices. Trigger scenes via the DMX signal from an external DMX controller. Map the software's DMX and Art-Net universes to the interface outputs in order to optimise the memory storage capacity of the controller in Stand Alone mode. Manually choose the number of active channels for each DMX universe. You can also choose the DMX output range to save in the Art-Net show file.

Clock tab

Displays the time and date of the selected interface from the list. Modify the time and date (minutes, hours, days, months and years). Synchronize the interface clock using the current computer time and date by selecting the option: Set Current Date and Time. You can calibrate your interface clock and choose winter or summer (standard or daylight savings) time.

Options tab

Turn off the LED display after 4 seconds of inactivity. For each Zone, select a default scene to play automatically after powering up the interface (with USB or external power supply). Note: the selected default start scene loses priority if another scene has the option "restore if power off".

When the Merge In/Out option is activated, the input from Line B (DMX-B) is analysed and combined with the interface output A (DMX-A), such that both DMX streams are merged in real time according to HTP priority (highest DMX level).

Configure the "Select dimmer channels" option to choose Dimmer or RGBW channels separately to be controlled directly by a dimmer button or dry contacts or to play a cross fade on selected channels.

Master / Slave tab

Select the Master/Slave mode when using multiple interfaces in order to synchronize their standalone mode. Refer to each interface datasheet to understand the possible configurations.

Triggers tab

Select a contact for each action: Dimmer +, Dimmer -, Blackout, Speed +, Speed -, Pause, Scene +, Scene - and Area. These actions are also possible with the UDP protocol.

Zone Tab

Displays a summary of the Zone DMX configuration and the associated DMX addresses.

STAND ALONE OPERATION

Reverting to Stand Alone mode

The interface enters Stand Alone mode within 5 seconds of powering on if no control software connection is detected.

External Power supply and USB

The external power supply is used only for Stand Alone mode. If a USB cable from a computer is connected to the interface when operating in Stand Alone mode, the device will reboot only the USB connection and won't affect the played scenes.

Battery charging

Before deploying the interface in Stand Alone mode, connect the interface for 1 hour in order to charge the clock battery and to avoid losing saved configurations.

Micro SD Card

Shows can be saved to a micro-SD card installed in the interface's SD card slot or connected to the computer. The card must be CLASS 10, formatted as FAT or FAT 32, with a maximum capacity of 256 GB.

SD Card connected to computer: in Stand Alone mode, click **Save to Memory**, then select **Save on external SD Card**. Save to the root directory of the SD card. (Faster recommended process).

The default show file name is "sdcardshowv2.sdq".

Art-Net or sACN shows: select the option with Art-Net icon to **Save on external SD Card**.

The default show file name for Art-Net or sACN is "artnetshowv2.sdq"

SD Card installed in the interface: select **Save to device's SD Card**.

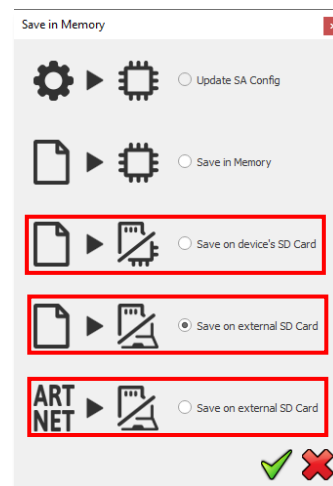
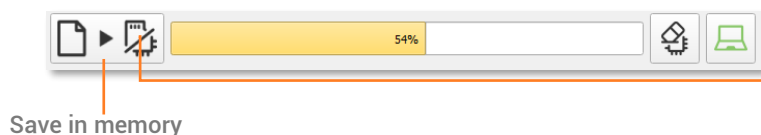

To play the SD show in Stand Alone, insert the card into the interface's micro-SD slot. When the card is booted, the display will show "Sd" to indicate that the SD show is playing the file correctly.

Note: the show file must be saved to the micro-SD root directory. It will not play if the file is renamed or saved to a folder or subdirectory.

Notes regarding recommended SD card specifications:

The class of the SD card indicates its read/write speed. Higher class numbers (e.g., class 10) offer faster speed and a better compatibility.

Class 6 or higher is preferred for optimal system performance. Older SD cards of type class 2 and 4 may not work. Choose class 10 micro-SD cards for mobile phones.

Choosing Stand Alone modes

It is possible to customize the interface according to the modes used in Stand Alone.

Drag and drop mode icons to arrange their order. Right click to Add or Remove a mode.

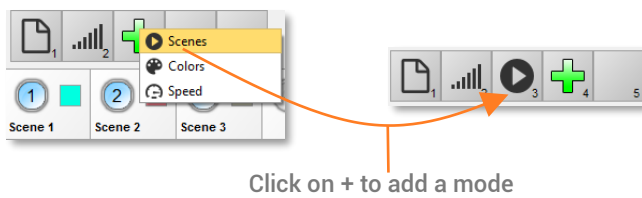
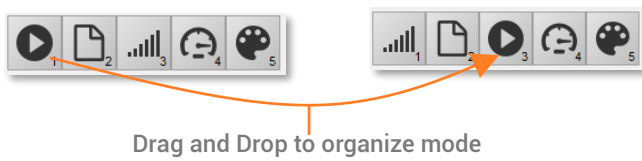
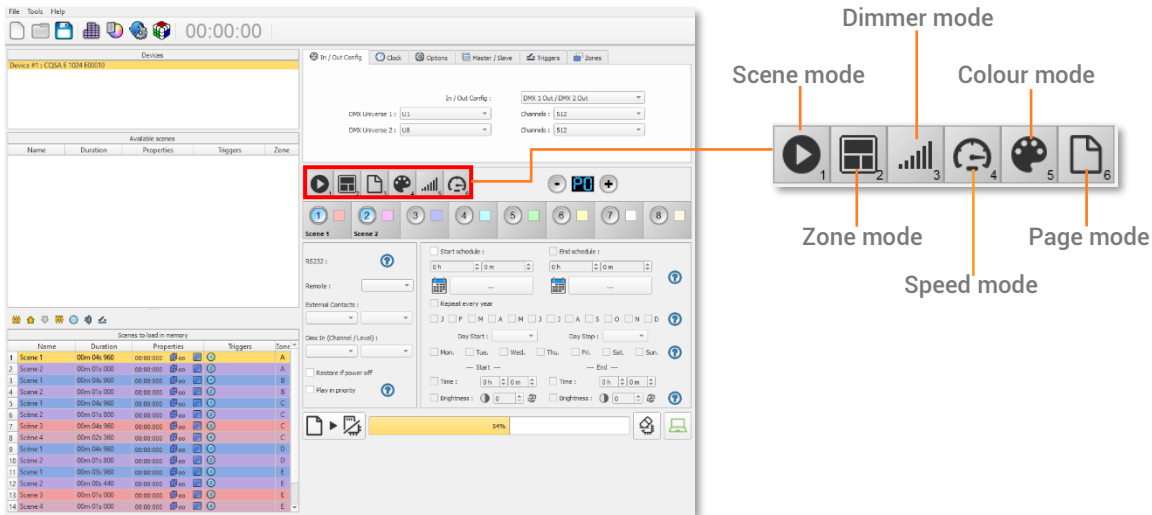

TRIGGER CONFIGURATION

The software's Stand Alone mode enables configuration and customization of all triggers. Configuration information is saved to the interface with the memory writing function.

Buttons

Stand Alone mode offers 8 graphical buttons that represent the interface's 8 physical LED buttons.

From the scene list in Stand Alone mode, drag and drop a scene on any button to assign a button number.

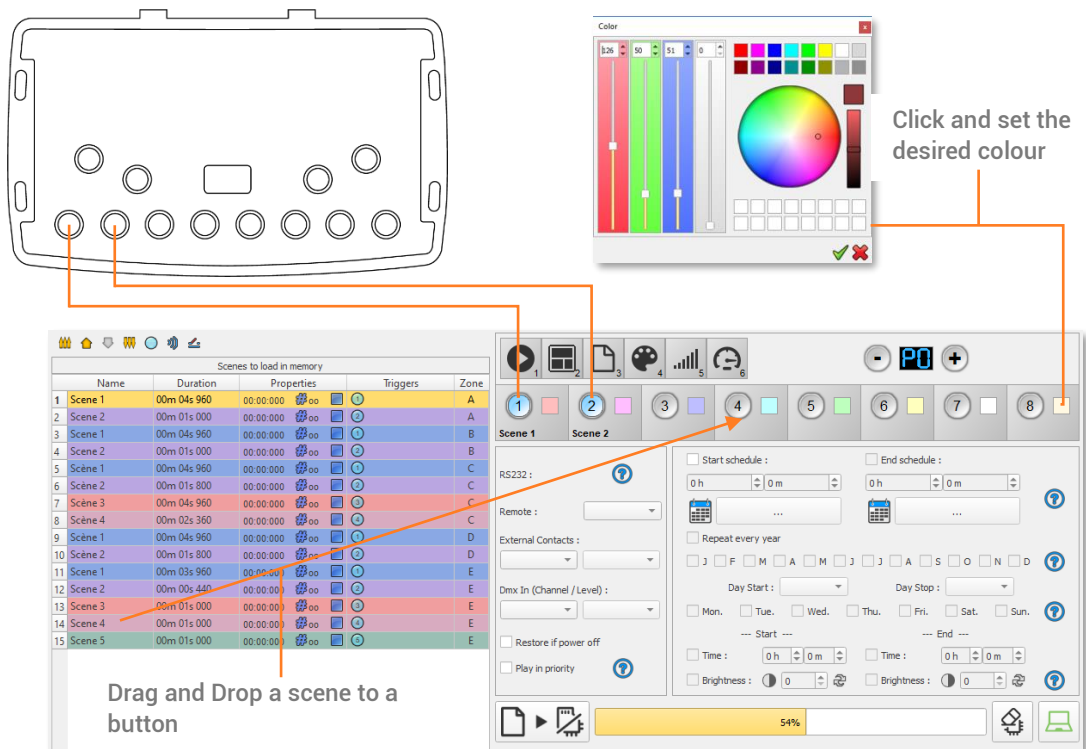

It is possible to replace a scene by another one or to remove a scene by pulling it out of the list.

Custom colours can be assigned to each button for playback in Colour mode by clicking on the square colour icon next to the graphical button and selecting the desired colour with sliders, wheel or swatches.

Clock and calendar

Stand Alone mode includes an internal clock and calendar. Time triggers can be assigned to every scene in the scene list. (255 max)

Start and end schedules can be programmed according to calendar dates, hours and minutes, and further defined by days of the week, enabling fully-automated scheduled playback.

CASE 1: Programming a unique trigger:

Start schedule: A single instance of the scene triggered at the given date and time

End schedule: The scene stops at the given date and time.

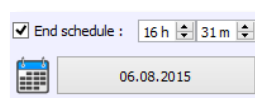
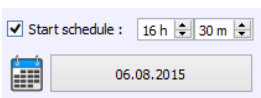

CASE 2: Programming a repeating trigger:

Start schedule: effective Date from which the scene will be playable according to the programmed triggers

End schedule: Date after which triggers will be ignored. With no End date, triggers will run continuously

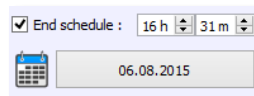
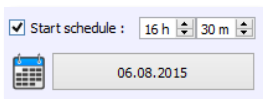

Repeat months, list of the months of the year

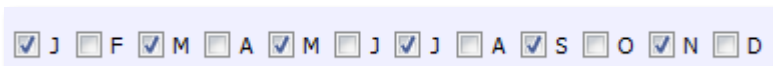

The 12 check boxes represent the 12 months of the year (J) January to (D) December. The triggers will be performed on the selected months. Next, a daily hour range must be defined to each month.

Start and Stop days



With a monthly repetition, starting and stopping days for each chosen month can be selected. In this example, triggers are performed between the 1st and the 15th of each chosen month.

List of the days of the week

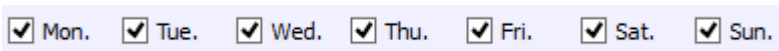

The check boxes represent the 7 days in a week. The triggers will be performed on the selected days only. Next, a time range must be defined.

Start time: Determines the daily start time when the scene will be triggered on each chosen day, according to the schedule of chosen months, days of the week, and start and end dates.

Release time: Determines the daily stop time when the scene will be stopped on each chosen day (following the schedule of chosen months, days of the week, and start and end dates). Setting the release time is optional. If not defined, the scene will keep playing until another trigger event happens (e.g., the triggering of another scene).

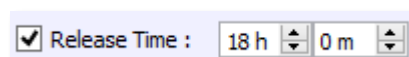
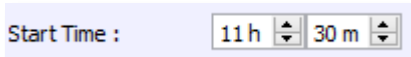

NOTE: For a daily repetition, if the start time is later than the release time, the triggering will stop the next day, even if the next day has not been selected.

Dry contact

The 7 external contacts are located on the second RJ45 connector (RJ2). The 7 dry contacts can be used to trigger 7 scenes via external relay when 3V3 to 5V is connected to one of the trigger pins. Adding more than 7 triggers requires a multiplexed system (for a maximum of 127 contacts maximum).

External Contact Closures can be done only when Pins 2, 3, 4, 5, 6, 7, 8 are connected to Pin 1 corresponding to the 5V DC of the interface. Triggers can operate within a power range of 3V3 to 5V DC.

Pin Table:

Trigger 01 = Pin 2	Trigger 09 = Pin 2 + 5
Trigger 02 = Pin 3	Trigger 10 = Pin 3 + 5
Trigger 03 = Pin 2 + 3	Trigger 16 = Pin 6
Trigger 04 = Pin 4	Trigger 32 = Pin 7
Trigger 05 = Pin 2 + 4	Trigger 48 = Pin 6 + 7
Trigger 06 = Pin 3 + 4	Trigger 64 = Pin 8
Trigger 07 = Pin 2 + 3 + 4	Trigger 100 = Pin 4 + 7 + 8
Trigger 08 = Pin 5	Etc...

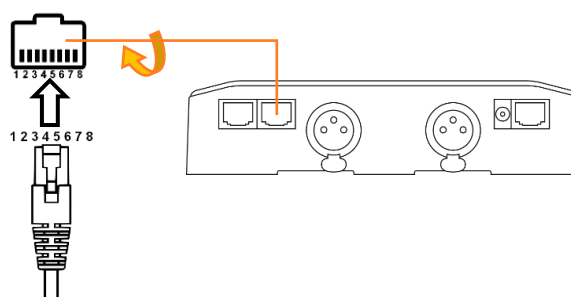

By selecting a scene in the list, it's possible to choose the external contact number (from 01 to 127) to trigger the scene.

By default, the interface offers 7 external contacts (01, 02, 04, 08, 16, 32, 64).

To deploy up to 127 external contacts, a de-multiplexing interface is required in order to use the other possible combinations.

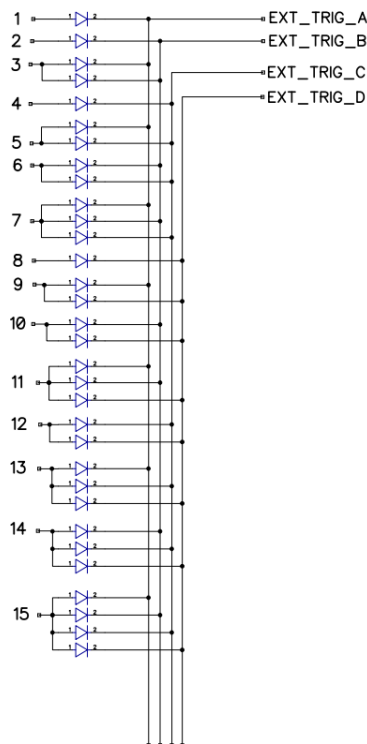
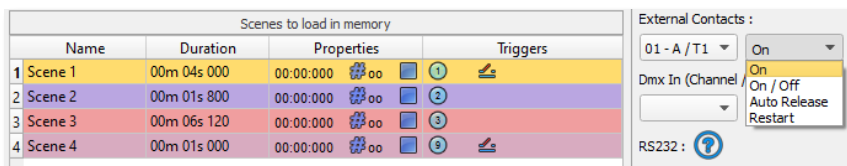

Several trigger options are available for external contact triggers:

On: Activating the contact plays the scene (only trigger action is to start the scene).

On/Off: Activating the contact starts the scene, subsequent activation stops the scene. Each trigger action will invert the state of the scene (start/stop).

Auto Release: The scene plays while the contact is activated. When the contact is released, the scene stops.

Restart: If the scene is playing, activating the contact will restart the scene from its beginning. If the scene is not playing, then it will start.

Dry contact reaction time: 8 ms (0.008 s) / Time between 2 contacts: 500 ms (0.5 s)

Contact commands

External contacts can also trigger commands in Stand Alone mode. From the Triggers tab you can select a contact for each action: Dimmer +, Dimmer -, Blackout, Speed +, Speed -, Pause, Scene +, Scene - and Area.

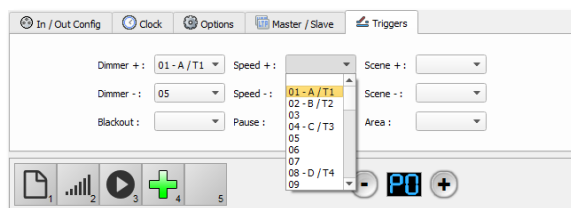

Note: It is not possible to use the same trigger for scene and command. In this case, the scene contact has the priority or the scene will lose its contact trigger information after choosing the contact from the Trigger command tab.

Wi-Light 2 App and UDP

When connected to a local Network with a WIFI access point, it is possible to trigger and command the interface with the Wi light 2 application for android and iOS when running in stand alone mode. This wireless remote-control feature is also available over the internet with the Web Remote option.

Each device, interface and mobile must be connected to the same access point in DHCP (recommended) or Static IP mode. Then the App will detect the interface and display the list of scenes and the other possible controls and commands. Web remote option requires the creation of a user account and registration of your interfaces prior to deployment.

Please refer to the Wi Light 2 manual to use this feature.

The Wi Light 2 App uses an open protocol for developers, with standard communication based on UDP commands.

Infrared



To use the optional IR remote control, an external PCB with an IR receiver must be connected to the first RJ45 port on the Stand-Alone interface. The maximum cable distance to the receiver is approx. 20 meters.

Button 1 to 10 must be assigned to a scene via the software. Each button triggers a different scene. With the remote control, a scene cannot be stopped directly with the assigned button. To stop a scene, press the Black Out (Stop) button or trigger another scene.

Pause button freezes the current scene in its current state.

Black Out button stops the current scene and plays the empty scene number 00. All DMX channel levels are set to zero.

+/- for scene trigger: Selects the next or previous scene automatically. No need to hold the button to confirm and play a scene. The next or previous scene will play directly after selected.

+/- for Scene speed: Increases or decreases the speed of the current scene. A different speed can be chosen separately for each scene.

+/- for Master dimmer: Increases or decreases the RGB, CMY and dimmer channels of the fixtures. The CMY, RGB, Dimmer channels are defined in the Profile of the fixture and the stand-alone mode.

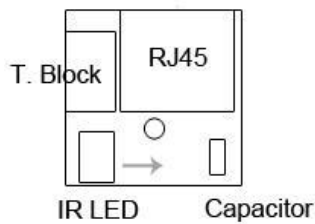

IR PCB Pin assignment:

-With RJ45 use pins: **#8** = Ground; **#4** = IR Data; **#7** = 5V DC.

-With T. Block use pins: **O** = IR Data; **V** = 5V DC; **G** = Ground.

To assign a remote button to a scene: in the software go to Stand Alone Mode and use the Triggers options. Stand Alone mode offers up to 10 triggers with the Infrared remote.

By selecting a scene in the list, it's possible to choose the remote button number (from 01 to 10) to trigger the scene.

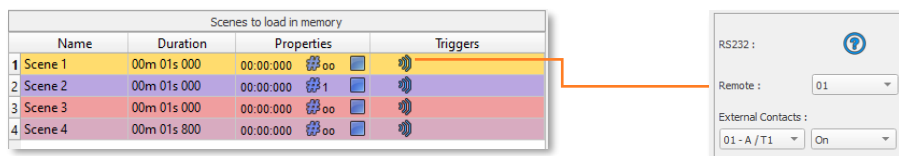

Light Sensor

The light sensor function works only with Time triggers. The external PCB must be connected to the first RJ45 and the light sensitivity defined in the software.

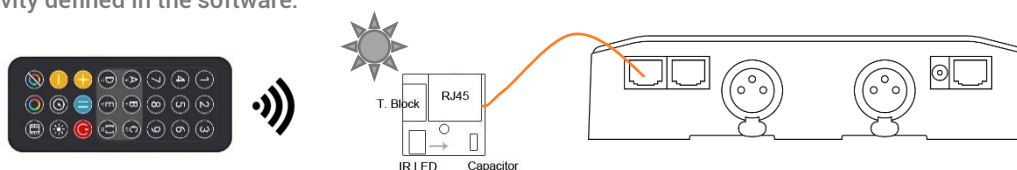

DMX in

Stand Alone mode offers up to 512 DMX IN channel triggers and up to 255 DMX trigger values per channel. This enables triggering scenes directly from an external DMX source.

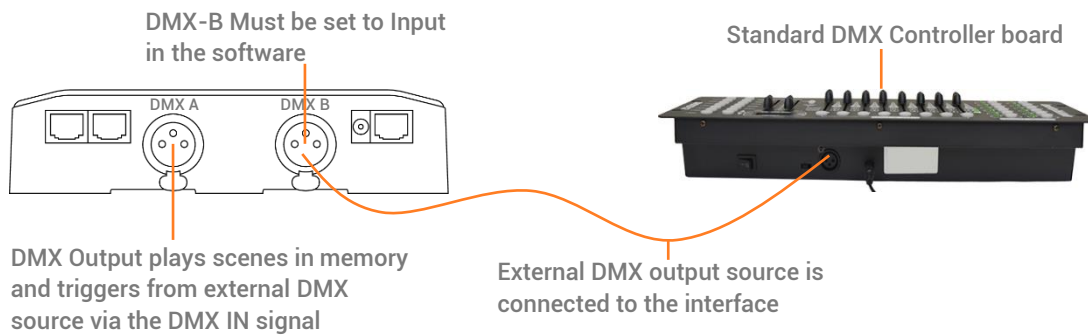

In Stand Alone window, set In / Out Config as DMX 1 Out/DMX 2 In, and select the DMX Out universe

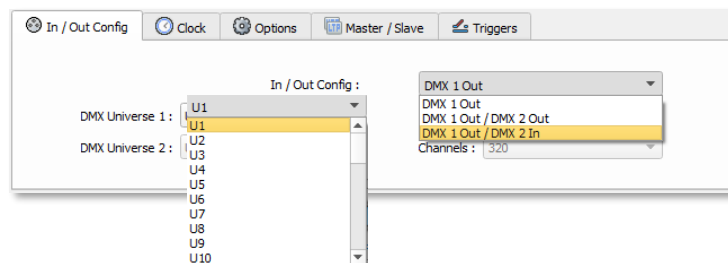

By selecting a scene in the list, it's possible to choose the channel number and the DMX value to trigger the scene. The scene will play when the DMX channel value is reached or exceeded.



OTHER ADVANCED TRIGGER OPTIONS

Scene recovery after power off

The interface can recall the last scene played before power is cut off, and recover that scene when the power is restored.

Each scene has the option to select "Restore if power off"
This option will take priority over the default start scene.

Click to enable the option

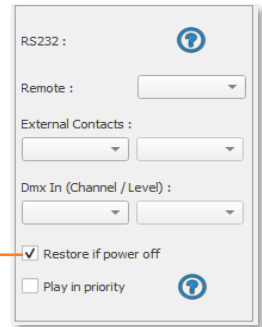

Time Trigger Priority

If several scenes share an identical time trigger (same date: hour: minute), only the last scene in the list will be triggered, and the other scenes will be ignored.

Play in Priority

The "Play in Priority" option allows scene playback that ignores all other triggers (except for touch button and scheduled clock triggers), allowing the scene to play completely to its end without interruption.

Click to enable the Play in priority option:

The scene will keep playing. No other triggers will be allowed (contacts, Infrared, DMX) while the scene is playing (except Time/calendar schedules and buttons)

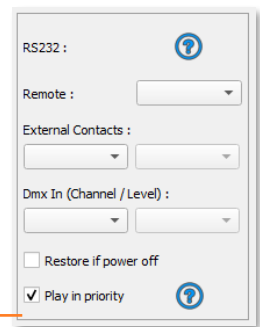

ZONE SETTINGS AND CONFIGURATION

The interface has the capability to play 1 scene per zone and up to 5 zones at the same time in Stand Alone mode.

It is also possible to extend the last zone over several universes using a Master / Slave daisy chain of multiple interfaces. The Master interface stores all five zones in memory and its last zone drives the Slave interfaces, which only have the last zone in memory.

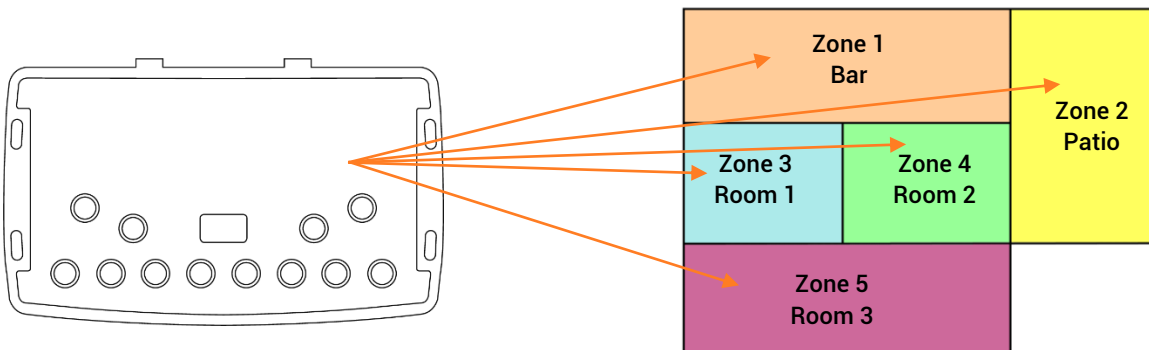

Editor mode

In the zone window, move the central bar to define the zone parameters. It is also possible to manually choose the zone range in the fields.

Note: Make sure the DMX Patch and fixture addresses correspond to the defined Zones.

Click on + to add zones

The zone window can be displayed by clicking on the « Zone » button

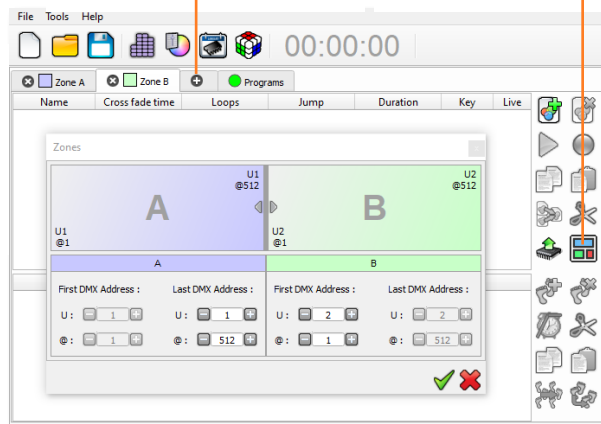

Once zones are defined, create scenes in the corresponding tab:

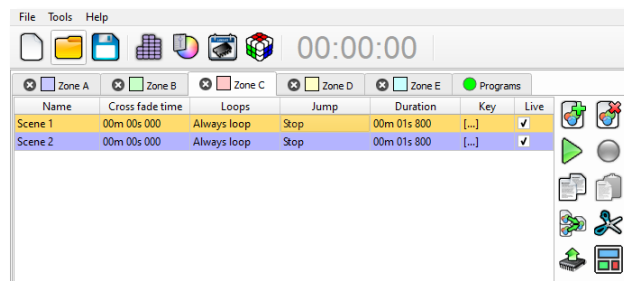

Standalone Mode

The Zone option can be configured in Standalone mode (manual Zone selection to enable or not the mode in the stand-alone menu)

The « Zones » tab allows to display and configure each zone (double click on a zone to edit)

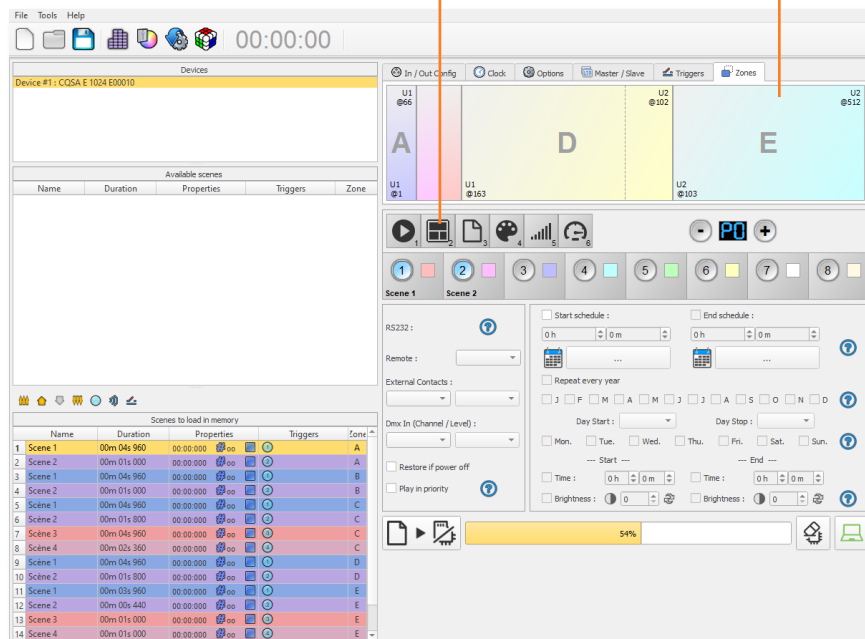

MASTER/SLAVE SETTINGS AND CONFIGURATION

Cable Master / Slave (up to 32 interfaces).

When multiple interfaces are connected with USB, the Stand-Alone mode allows to set them as Master/Slave. This mode synchronises the 2 interfaces and mutualizes their Stand-Alone spaces, combining the universes.

Here is an example of wiring 2 interfaces connected as Master/Slave with a standard RJ45 cable. The first Ethernet sockets are connected as shown:

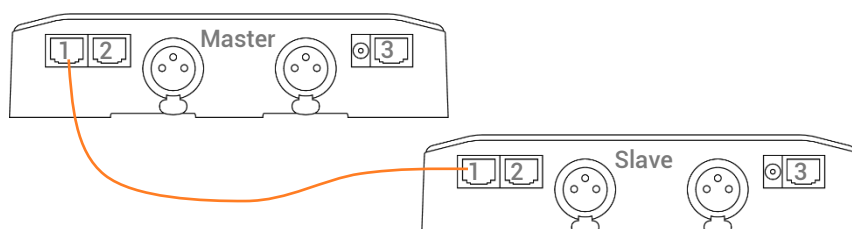

Configuring Master/Slave interfaces

When one interface is defined as master in the software, the other interfaces are automatically set to slave mode. There are four different modes of master/slave interaction: Default, Desynchronized, LTP and No Release.

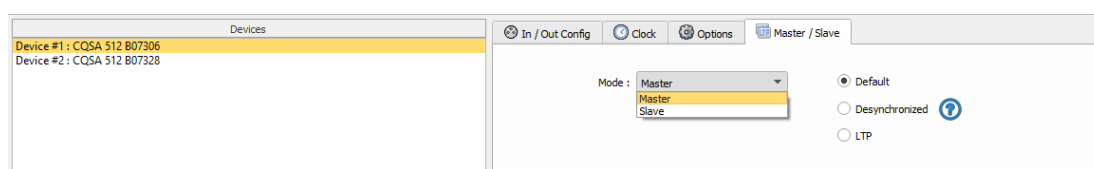

MODE MASTER/SLAVE « Default »

A single interface is defined as master (lower serial number by default), with others automatically set to slaves. The master device plays the current scene and synchronizes the slave interfaces. The master forces the slave interfaces to play the same scene and the same step at the same time. The slave interfaces are forced to follow the master timings and triggers and they cannot act, play or trigger a scene independently. Master can trigger on and trigger off scenes of the slave interfaces.

MODE MASTER/SLAVE « Desynchronized »

An interface can be defined as master, others are automatically set to slaves. All Triggers On or Off operated on the master interface are effective to slave ones. However, slave interfaces are not synchronized with master interface timing and retain individual control. Consequently, slaves can trigger and play different scenes at any time and not synchronized with the master ones. The master acts like a general remote imposing triggering to the slaves with total priority. Master can trigger ON and trigger OFF scenes of the slave interface.

MODE MASTER/SLAVE « LTP »

LTP means Latest Takes Priority. All interfaces are defined as slaves. Interfaces are not synchronized with timing and can trigger and play different scenes by itself. However, triggers from an interface are passed to the other connected interfaces automatically and slave interfaces are forced to trigger the same scene. In this mode, each interface acts like a general remote imposing triggering to the other slaves without synchronization.

THE «NO RELEASE» Option

This option is only available with LTP or DESYNCHRONIZED modes. Only triggers ON from the master interface are executed and effective. All triggers OFF are ignored and slave interfaces keep playing their current scene. Each Slave interface can choose to release or not its scene depending on if the option is activated or not.

Ethernet Master / Slave

Master/Slave operation over Ethernet networks functions the same as the modes described earlier. This option offers longer cable distances between connected interfaces and allows up to 128 interfaces to be connected. This option can be enabled/disabled in the Master/Slave tab of the software's Stand-Alone mode settings. The interface must be correctly configured to communicate by DHCP or static IP on the local network.

NOTE: It is recommended to select this option only when necessary and with only one Master on the network. If several Master interfaces are present on the same network, the signal will become unstable.

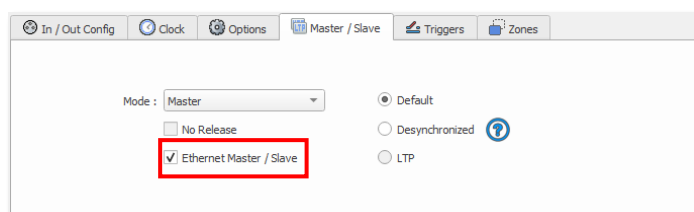

ART-NET and sACN SETTINGS AND CONFIGURATION

The Ethernet interface can play an Art-Net or sACN show in Stand Alone mode. The show is saved on the SD card and will control up to 8 universes maximum per interface. All triggers work in these modes as well as the Master/Slave mode. When the interface is in SA mode, the F3 function allows activation of the Art-Net or sACN mode.

NOTES: Once in Art-Net (Ar) or sACN (AC) Stand Alone mode, the interface will no longer be visible on the network. In Art-Net mode, the interface will use Broadcast to play the show over the network. In sACN mode, the interface will use Multicast to play the show over the network.

IMPORTANT Note: It is necessary to connect the interface to the Ethernet network *BEFORE* powering ON in order to properly start the ArtNet or sACN mode. Otherwise, it is necessary to restart the interface with one of the following 3 methods: Restart (disconnect and reconnect the DC power supply); or, Reset (eject and re-insert the SD card); or, Reselect the ArtNet mode (Ar) or sACN (AC) mode in the advanced F3 menu of the interface (Press to confirm the selected mode. The interface will immediately reboot to activate the new mode).

Recording Art-Net or sACN shows to memory

Art-Net and sACN shows can extend up to 8 universes per micro-SD cards and per interface. It is necessary to define the universe range. In the **In / Out Config** tab, choose the starting universe and the ending universe. Then click on the **Save in Memory** button and select **Art-Net Save on External SD Card**.

Select universe range

Save in memory

Art-Net Save on External SD Card

Confirm

NODE SETTING AND CONFIGURATION

The interface can be used as a NODE to convert Art-Net into x2 DMX outputs of 512 channels each, with IP address using Ethernet LAN. It will be detected on the Art-Net network and DMX universes can be assigned to its DMX outputs. When the interface is in Stand Alone mode, the F3 function allows access to the NODE mode. Once in NODE mode, the interface displays (No) and it is now visible on the Art-Net network.

NODE configuration from software

It is possible to configure the NODE from the software.

Go to the "Tools" and "Options" menu and select the "Device" tab.

In the "Ethernet" tab, in addition to the Network Configuration, the Node section allows you to configure your node.

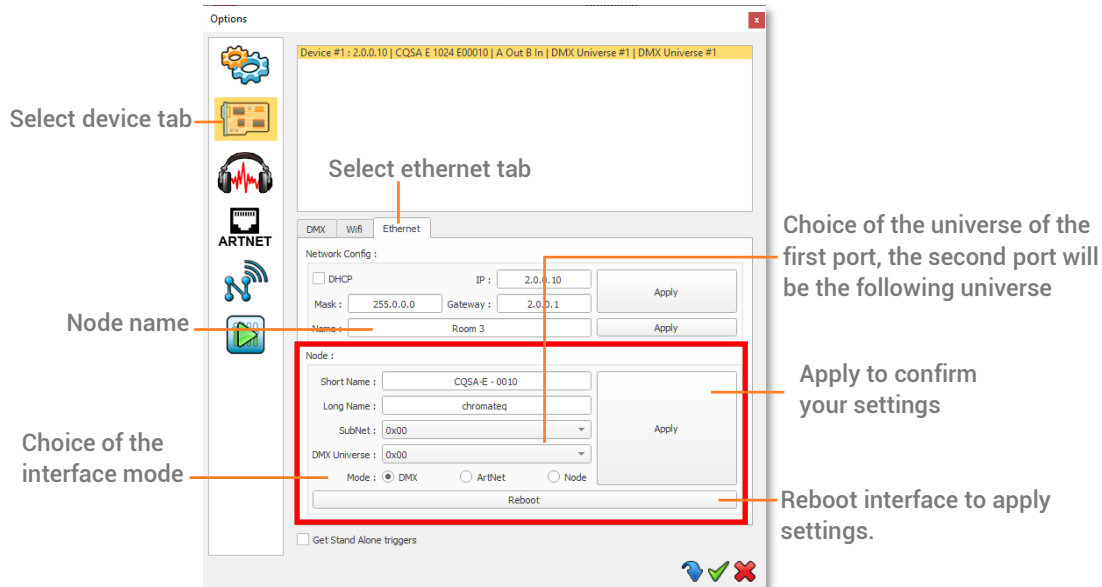

DMX MERGE CONFIGURATION

One DMX port must be turned into an input to capture the DMX signal provided by another DMX source. The interface will merge the incoming signal with its own output signal by comparing the DMX levels with an HTP filter (priority on the highest levels of the signals). Merging is a solution to keep manual control of channels when using a DMX board, for example. It's also a method to create a multi-zone system by merging several interfaces on one final DMX line. In this last case, each interface can play a scene dedicated to the fixtures at the same time and on the same DMX line.

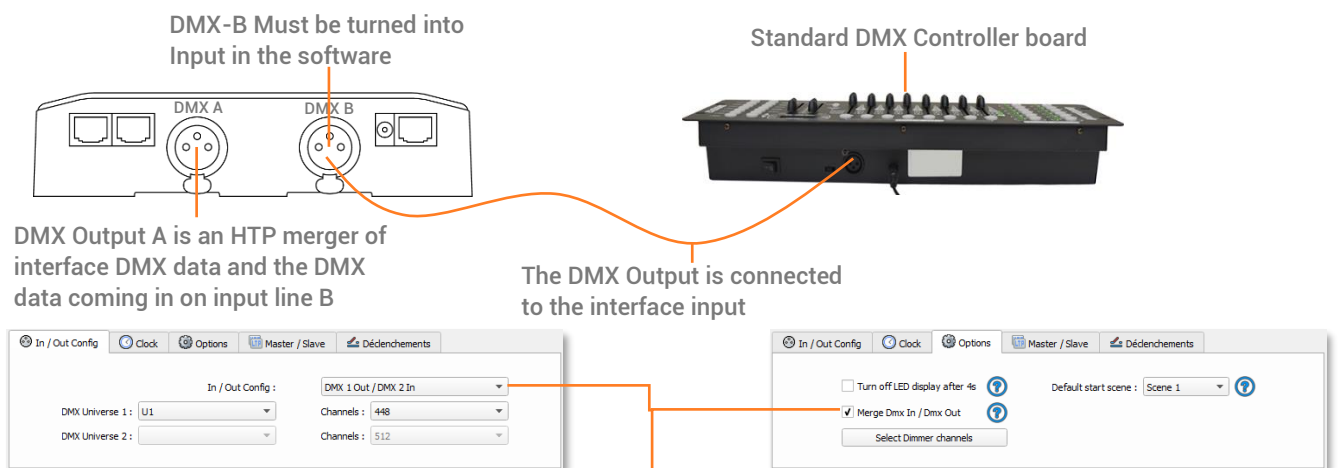

In the software's standalone window, select: "DMX 1 OUT / DMX 2 IN" and confirm the merge option

PHYSICAL DIMENSIONS

Metric unit measurements in mm.

Rear panel

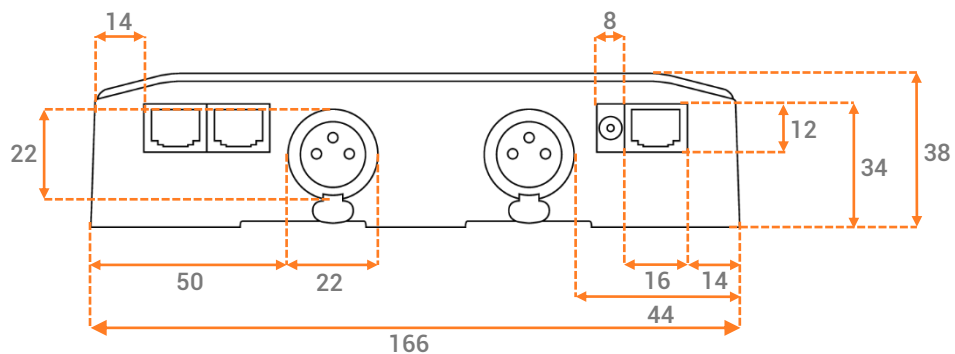

Side panels

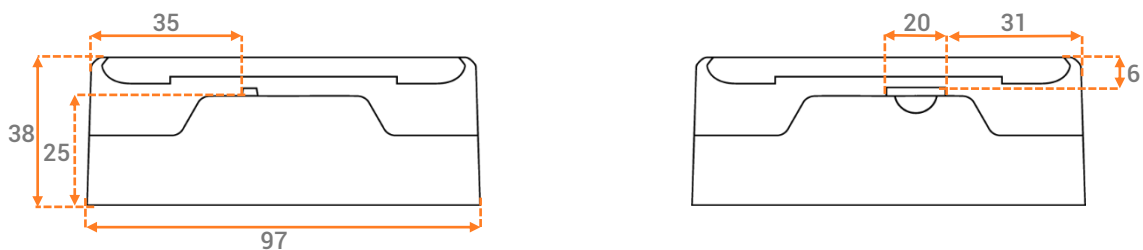

Bottom panel

