

USER MANUAL

# WELL STX 180

WIRELESS EVENT LED LUMINAIRE

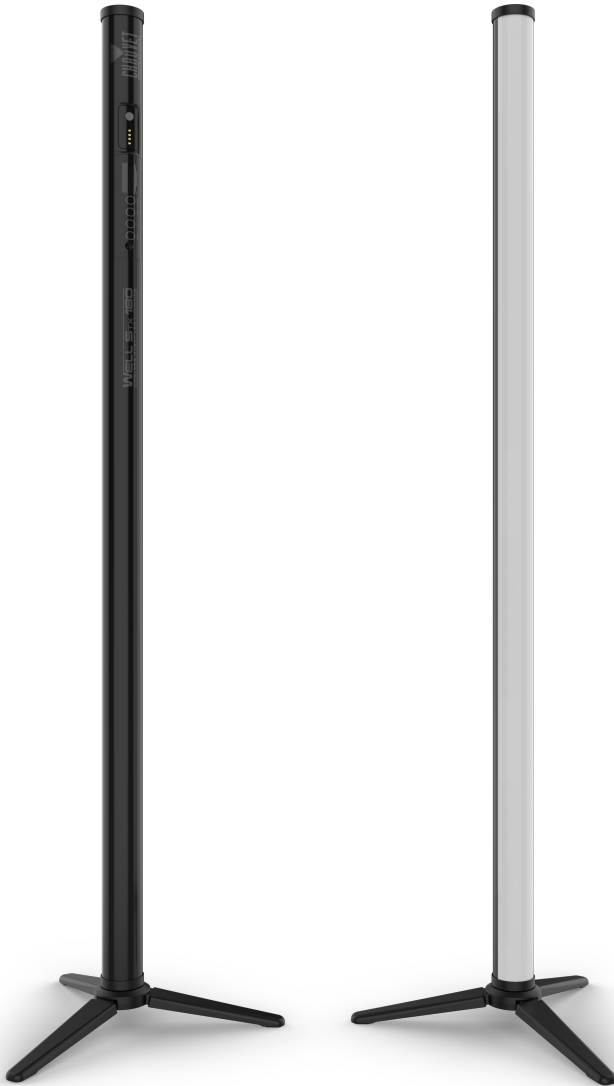

## Edition Notes

The WELL STX 180 User Manual includes a description, safety precautions, installation, programming, operation and maintenance instructions for the WELL STX 180 as of the release date of this edition.

## Trademarks

CHAUVET, the Chauvet logo and WELL STX 180 are registered trademarks or trademarks of Chauvet & Sons, LLC (d/b/a Chauvet and Chauvet Lighting) in the United States and other countries. Other company and product names and logos referred to herein may be trademarks of their respective companies.

## Copyright Notice

The works of authorship contained in this manual, including, but not limited to, all design, text and images are owned by Chauvet.

© Copyright 2021 Chauvet & Sons, LLC. All rights reserved.

Electronically published by Chauvet in the United States of America.

## Manual Use

Chauvet authorizes its customers to download and print this manual for professional information purposes only. Chauvet expressly prohibits the usage, copy, storage, distribution, modification, or printing of this manual or its content for any other purpose without written consent from Chauvet.

## Document Printing

For best results, print this document in color, on letter size paper (8.5 x 11 in), double-sided. If using A4 paper (210 x 297 mm), configure the printer to scale the content accordingly.

## Intended Audience

Any person installing, operating, and/or maintaining this product should completely read through the guide that shipped with the product, as well as this manual, before installing, operating, or maintaining this product.

## Disclaimer

Chauvet believes that the information contained in this manual is accurate in all respects. However, Chauvet assumes no responsibility and specifically disclaims any and all liability to any party for any loss, damage or disruption caused by any errors or omissions in this document, whether such errors or omissions result from negligence, accident or any other cause. Chauvet reserves the right to revise the content of this document without any obligation to notify any person or company of such revision, however, Chauvet has no obligation to make, and does not commit to make, any such revisions. Download the latest version from [www.chauvetprofessional.com](http://www.chauvetprofessional.com).

## Document Revision

This WELL STX 180 User Manual is the 1<sup>st</sup> edition of this document. Go to [www.chauvetprofessional.com](http://www.chauvetprofessional.com) for the latest version.

TABLE OF CONTENTS

- 1. Before You Begin** ..... 1
  - What Is Included ..... 1
  - Claims ..... 1
  - Manual Conventions ..... 1
  - Symbols ..... 1
  - Expected LED Lifespan..... 1
  - Safety Notes..... 2
    - Personal Safety..... 2
    - Mounting and Rigging ..... 2
    - Power and Wiring..... 2
    - Operation ..... 2
  - FCC Compliance..... 2
- 2. Introduction** ..... 3
  - Features ..... 3
  - Product Overview..... 3
  - Product Dimensions ..... 4
- 3. Setup**..... 5
  - AC Power ..... 5
    - AC Plug ..... 5
    - Power Linking..... 5
    - Battery Charge Notes..... 5
    - Storage Notes ..... 5
  - DMX Linking..... 5
    - DMX Personalities..... 5
    - Wireless Operation..... 6
  - Master/Slave Connectivity..... 6
  - Mounting ..... 7
    - Orientation..... 7
    - Rigging..... 7
    - Procedure..... 7
  - Stealth Filter ..... 7
- 4. Operation** ..... 8
  - Control Panel Operation..... 8
  - Control Options ..... 8
  - Programming..... 8
  - Control Panel Lock..... 8
  - Configuration (DMX) ..... 8
    - DMX Personalities..... 8
    - Starting Address..... 8
  - Menu Map ..... 9
  - DMX Values ..... 12
    - 67Ch..... 12
    - 64Ch..... 14
    - 15Ch..... 15
    - 4Ch..... 17
  - Color Temperature Chart ..... 17

Configuration (Standalone) .....	18
Static Mode .....	18
Auto Programs .....	18
Auto Program Speed.....	18
White Balance .....	18
Run Time.....	18
Back Light .....	18
Dimmer Profiles.....	19
System Information .....	19
Factory Reset.....	19
Master/Slave Mode .....	19
Infrared Remote Control.....	20
IR Remote Operation .....	20
<b>5. Technical Information .....</b>	<b>21</b>
Product Maintenance .....	21
<b>6. Technical Specifications .....</b>	<b>22</b>
<b>Returns .....</b>	<b>23</b>
<b>Contact Us .....</b>	<b>24</b>

## Before You Begin

# 1. Before You Begin

## What Is Included

- (6) WELL STX 180
- TRUE1-style power cord with Edison plug (EU bare end)
- Charging flight case
- (6) stands
- (12) magnetic clamps
- (6) hanging eye bolts
- (6) stealth black filters
- Quick Reference Guide

## Claims

Carefully unpack the product immediately and check the container to make sure all the parts are in the package and are in good condition.





If the box or the contents (the product and included accessories) appear damaged from shipping, or show signs of mishandling, notify the carrier immediately, not Chauvet. Failure to report damage to the carrier immediately may invalidate your claim. In addition, keep the box and contents for inspection.

For other issues, such as missing components or parts, damage not related to shipping, or concealed damage, file a claim with Chauvet within 7 days of delivery.

## Manual Conventions

Convention	Meaning
<b>1–512</b>	A range of values
<b>50/60</b>	A set of values of which only one can be chosen
<b>&lt;SET&gt;</b>	A button on the product's control panel
<b>Settings</b>	A product function or a menu option

## Symbols

Symbol	Meaning
	Electrical warning. Not following these instructions may cause electrical damage to the product, accessories, or the user.
	Critical installation, configuration, or operation information. Not following these instructions may make the product not work, cause damage to the product, or cause harm to the operator.
	Important installation or configuration information. The product may not function correctly if this information is not used.
	Useful information.



**Any reference to data or power connections in this manual assumes the use of Seetronic IP-rated cables.**



**The term “DMX” used throughout this manual refers to the USITT DMX512-A digital data transmission protocol.**

## Expected LED Lifespan

Over time, use and heat will gradually reduce LED brightness. Clustered LEDs produce more heat than single LEDs, contributing to shorter lifespans if always used at full intensity. The average LED lifespan is 40,000 to 50,000 hours. To extend LED lifespan, maintain proper ventilation around the product, and limit the overall intensity.

## Safety Notes

Read all the following safety notes before working with this product. These notes contain important information about the installation, usage, and maintenance of this product.



**This product contains no user-serviceable parts. Any reference to servicing in this User Manual will only apply to properly trained, certified technicians. Do not open the housing or attempt any repairs.**



**All applicable local codes and regulations apply to proper installation of this product.**

## Personal Safety

- Avoid direct eye exposure to the light source while the product is on.
- Always disconnect the product from the power source before cleaning or replacing the fuse.
- Always connect the product to a grounded circuit to avoid the risk of electrocution.
- Do not touch the product's housing when operating because it may be very hot.

## Mounting and Rigging

- Do not submerge this product (IP65). Temporary outdoor operation is fine.
- CAUTION: When transferring product from extreme temperature environments, (e.g., cold truck to warm, humid ballroom) condensation may form on the internal electronics of the product. To avoid causing a failure, allow product to fully acclimate to the surrounding environment before connecting it to power.
- Not for permanent outdoor installation in locations with extreme environmental conditions. This includes, but is not limited to:
  - Exposure to a marine/saline environment (within 3 miles of a saltwater body of water).
  - Locations where the normal high or low temperatures exceed the temperature ranges in this manual.
  - Locations that are prone to flooding or being buried in snow.
  - Areas where the product will be subjected to extreme radiation or caustic substances.
- Mount this product in a location with adequate ventilation, at least 20 in (50 cm) from adjacent surfaces.
- Make sure there are no flammable materials close to the product when operating.
- When hanging this product, always secure to a fastening device using a safety cable.

## Power and Wiring

- Always make sure you are connecting the product to the proper voltage in accordance with the specifications in this manual or on the product's specification label.
- Never connect the product to a dimmer pack or rheostat.
- Never disconnect this product by pulling or tugging on the power cable.

## Operation

- Do not operate this product if there is damage on the housing, lenses, or cables. Have the damaged parts replaced by an authorized technician at once.
- Do not cover the ventilation slots when operating to avoid internal overheating.
- The maximum ambient temperature is 113 °F (45 °C). Do not operate the product at higher temperatures.
- The minimum startup temperature is -4°F (-20°C). Do not start the product at lower temperatures.
- The minimum ambient temperature is -22°F (-30°C). Do not operate the product at lower temperatures.
- In the event of a serious operation problem, stop using this product immediately!



**If your Chauvet product requires service, contact Chauvet Technical Support.**

## FCC Compliance

This device complies with Part 15 Part B of the FCC Rules. Operation is subject to the following two conditions:

1. This device may not cause harmful interference, and
2. This device must accept any interference received, including interference that may cause undesired operation.

Any changes or modifications not expressly approved by the party responsible for compliance could void the user's authority to operate the equipment.

## RF Exposure Warning for North America, and Australia

**Warning!** This equipment complies with FCC radiation exposure limits set forth for an uncontrolled environment. This equipment should be installed and operated with a minimum distance of 20cm between the radiator and your body. This transmitter must not be co-located or operating in conjunction with any other antenna or transmitter.

## Introduction

# 2. Introduction

## Features

- (6) pixel-mapping, battery-operated, 1 meter, IP65-rated LED strips with 180° viewing angle, including (6) mounting stands, (12) magnetic brackets, (6) hanging eye bolts, (6) stealth black filters, (1) IR remote, and (1) charging case
- 16 individual zones of control for pixel mapping effects
- High-CRI (Color Rendering Index) LEDs for fantastic skin tone rendering
- Simple and complex operational modes
- Built-in editable pre-programmed effects that are controllable from the menu and over DMX
- 3-, 5-, 8-, and 12-hour settings for optimizing performance time
- Included accessories for several mounting options
- Included charging flat case for easy transportation and charging of fixtures
- Update software over USBc connection in flight case (upload all 6 fixtures at once)
- Works in both standalone modes and under DMX over W-DMX
- Works perfectly with the WELL COM controller and app

## Product Overview

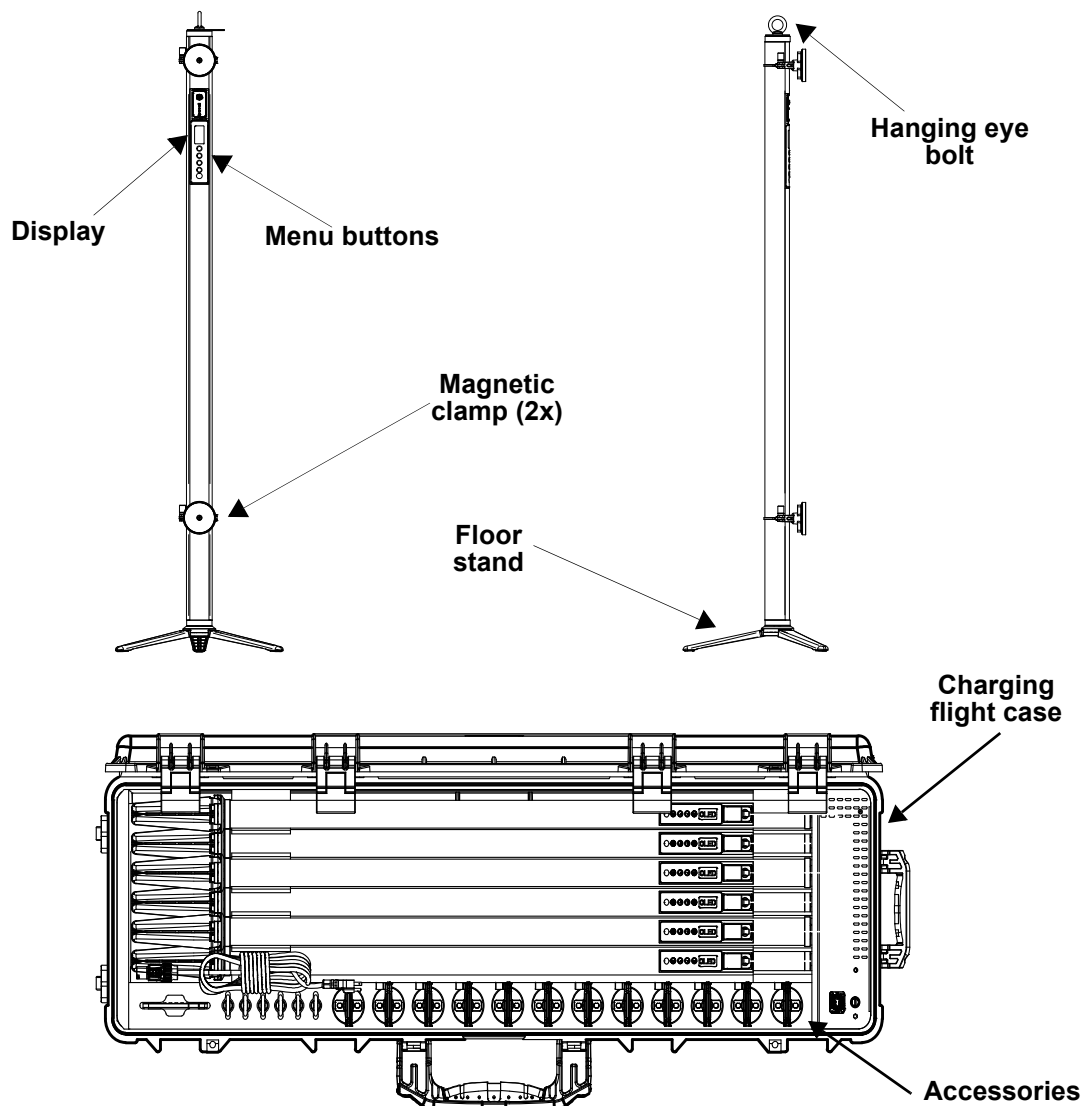

**Product Dimensions**

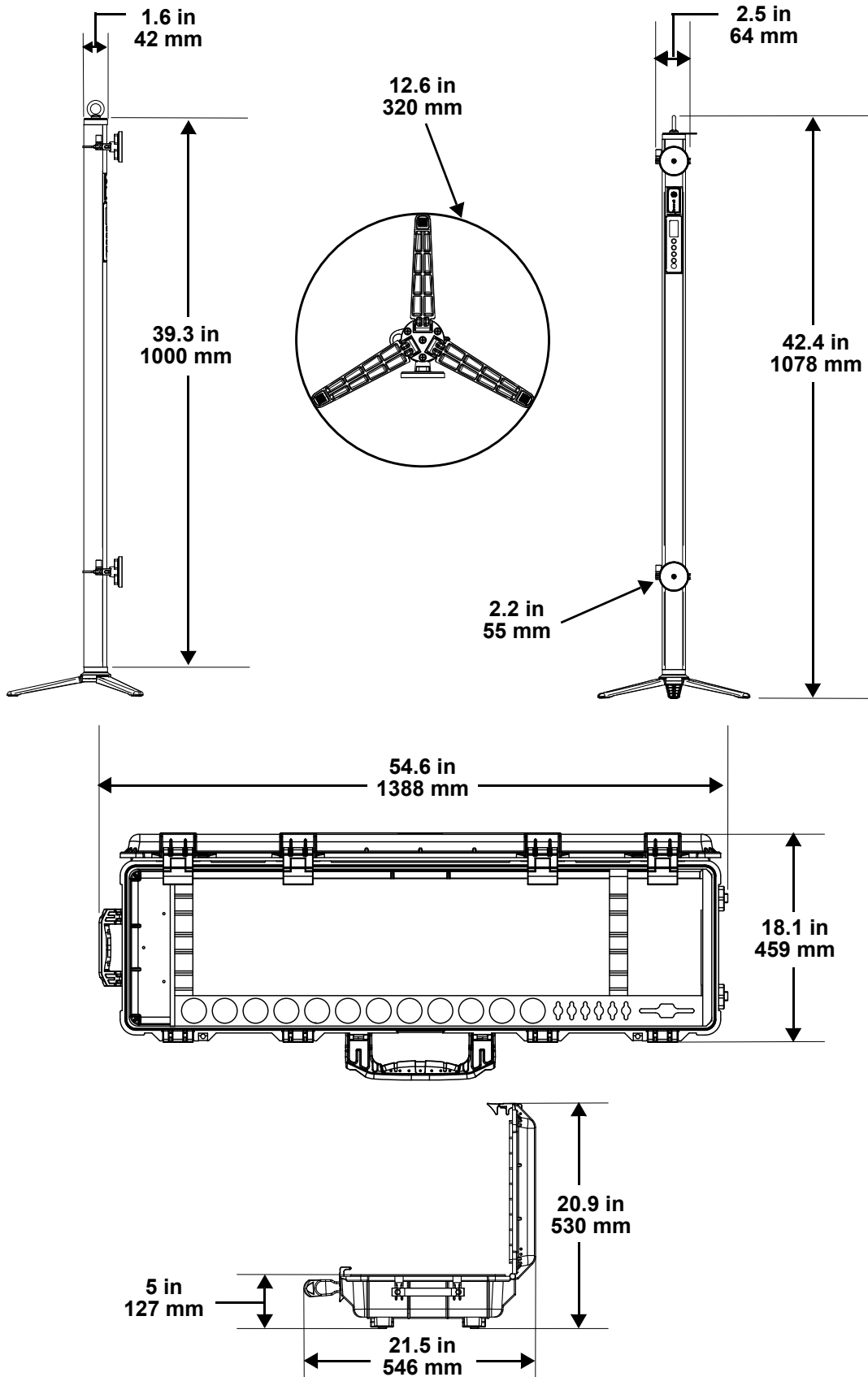



## 3. Setup

### AC Power

Each WELL STX 180 has an auto-ranging battery charger inside the fixture that works with an input voltage range of 100 to 240 VAC, 50/60 Hz. To determine the power requirements for each WELL STX 180, refer to the label affixed to the product or the [Technical Specifications](#) chart in this manual. The listed current rating indicates the maximum current draw during normal operation. For more information, download Sizing Circuit Breakers from the Chauvet website: [www.chauvetprofessional.com](http://www.chauvetprofessional.com).



- **Always connect the product to a protected circuit (a circuit breaker or fuse). Make sure the product has an appropriate electrical ground to avoid the risk of electrocution or fire.**
- **To eliminate unnecessary wear and improve its lifespan, during periods of non-use completely disconnect the product from power via breaker or by unplugging it.**



**Never connect the product to a rheostat (variable resistor) or dimmer circuit, even if the rheostat or dimmer channel serves only as a 0 to 100% switch.**

### AC Plug

The WELL STX 180 charging case comes with a power input cord terminated with a Seetronic Powerkon connector on one end and an Edison plug on the other end (U.S. market). If the power input cord that came with your product has no plug, or if you need the change the plug, use the table below to wire the new plug.

Connection	Wire (U.S.)	Wire (Europe)	Screw Color
AC Live	Black	Brown	Yellow or Brass
AC Neutral	White	Blue	Silver
AC Ground	Green/Yellow	Green/Yellow	Green

### Power Linking

The product supports power linking of up to 8 products at 120 V, and 11 products at 208 V and 230 V. This product comes with a power input cord. Power-linking cables are available from Chauvet for purchase.

### Battery Charge Notes

This product is equipped with a built-in rechargeable lithium-ion battery.

- Avoid depleting the battery below 10%.
- For best results, charge the battery in a temperature between 32 °F (0 °C) and 95 °F (35 °C).
- When charging the battery, keep the product at least 1 m from any open flame or hot plate.
- If the battery is completely discharged, the device cannot be turned on immediately when the charger is connected. Allow a depleted battery to charge a few minutes before turning on the device.
- While charging, the device may heat up. This is normal and should not affect the device's lifespan or performance. If the battery gets hotter than usual, the charger may stop charging.
- When charging the battery, keep the road case's cover open.
- Always charge the battery with the product in an upright position.
- Do not charge the battery for more than 24 hours.

### Storage Notes

- Store charged product(s) in a dry environment, away from direct sunlight.
- Charge or discharge the battery to approximately 50% of capacity before storage.
- Lithium-ion batteries continue to slowly discharge (self-discharge) when not in use or while in storage. Routinely check the battery's charge status.
- Store the battery at temperatures between 41 °F and 68 °F (5 °C and 20 °C).

### DMX Linking

The WELL STX 180 can be linked to a DMX controller using a wireless DMX connection. If using other DMX-compatible products with this product, you can control each individually with a single DMX controller.

### DMX Personalities

The WELL STX 180 uses a wireless DMX data connection for the **4Ch**, **15Ch**, **64Ch**, and **67Ch** DMX personalities.

- Refer to the [Operation](#) chapter to learn how to configure the WELL STX 180 to work in these personalities.
- The [DMX Values](#) section provides detailed information regarding the control personalities.



**If you are not familiar with or need more information about DMX standards, Master/Slave connectivity, or the DMX cables needed to link this product to a DMX controller, download the DMX Primer from the Chauvet website: [www.chauvetprofessional.com](http://www.chauvetprofessional.com).**

## Wireless Operation

In optimal conditions, the WELL STX 180 can operate up to 300 m (900 ft) away from the W-DMX TRX transmitter. The W-DMX receiver in the WELL STX 180 must be paired with the W-DMX TRX transmitter for wireless operation.



**Once a WDMX receiver has been linked to a specific W-DMX TRX transmitter, it will remain linked to that specific transmitter until it is linked to a different one.**

### Initial Setup

1. Turn the W-DMX TRX transmitter on.
2. Connect the W-DMX TRX transmitter to a DMX controller.
3. Place the WELL STX 180 within 300 m from the W-DMX TRX transmitter.
4. Turn the WELL STX 180 on.

### Configuration

1. From the WELL STX 180 control panel, go to **DMX Address**.
2. Select the start address, as with any other DMX compatible product.
3. Go to **Wireless Setting > Operating Mode**.
4. Select **Receive**.
5. Go to **Wireless Setting > W-DMX On/Off**.
6. Select **On**. (The Signal Strength Indicator will show a ? in front of the bars).
7. Press the reset button on the W-DMX transmitter. (The Signal Strength Indicator on the WELL STX 180 will show a ⚡ in front of the bars for 3 seconds while a connection is established.).

### Product Pairing

If the WELL STX 180 has already been paired with the W-DMX TRX transmitter, the Signal Strength Indicator in the middle of the LCD screen will show the strength of the signal. In this case, the WELL STX 180 is ready to work in wireless mode.

To pair the WELL STX 180 and a new W-DMX transmitter, follow the instructions below:

1. From the WELL STX 180 control panel, go to **Wireless Setting > Receive Reset**.
2. Select **Yes**. The Signal Strength Indicator on the WELL STX 180 will show a ? in front of the bars.
3. From the W-DMX transmitter, press **<RESET>** (the Signal Indicator on the transmitter will flash).
4. Once the transmitter has found the WELL STX 180, the Signal indicator on the W-DMX transmitter will illuminate solid.
5. The Signal Strength Indicator in the middle of the LCD screen on the WELL STX 180 will show the strength of the signal.



**W-DMX operation can be interrupted or inhibited by liquid masses between the transmitter and receiver. For best results, keep the area between the transmitter and receiver clear of any liquid mass.**

## Master/Slave Connectivity

The Master/Slave mode allows an WELL STX 180 (the master) to control one or more WELL STX 180 products (the slaves) without a DMX controller. One WELL STX 180 becomes the master when running an auto program, or by being in Static mode.

You must configure each slave's control panel to operate in Slave mode. During Master/Slave operation, the slaves will operate in unison with the master.



**DO NOT connect a DMX controller to products operating in Master/Slave mode. The DMX controller signals may interfere with the signals from the master.**



- The [Master/Slave Mode](#) section of this manual provides detailed instructions on how to configure the master and slaves.
- If you are not familiar with or need more information about DMX standards, or the DMX cables needed to link this product to a DMX controller, download the DMX Primer from the Chauvet website: [www.chauvetprofessional.com](http://www.chauvetprofessional.com).

## Mounting

Before mounting the product, read and follow the safety recommendations indicated in the [Safety Notes](#). For our CHAUVET Professional line of mounting clamps, go to <http://trusst.com/products/>.

### Orientation

Always mount this product in a safe position, making sure there is adequate room for ventilation, configuration, and maintenance.

### Rigging

Chauvet recommends using the following general guidelines when mounting this product.

- Before deciding on a location for the product, make sure there is easy access to the product for maintenance and programming purposes.
- Make sure that the structure onto which you are mounting the product can support the product's weight. See the [Technical Specifications](#) for weight information.
- When mounting the product overhead, always use a safety cable. Mount the product securely to a rigging point, whether an elevated platform or a truss.
- When rigging the product onto a truss, use a mounting clamp of appropriate weight capacity.
- When power linking multiple products, mount the products close enough for power linking cables to reach.
- The bracket adjustment knobs allow for directional adjustment when aiming the product to the desired angle. Only loosen or tighten the bracket knobs manually. Using tools could damage the knobs.

### Procedure

The WELL STX 180 comes with a bracket to which you can attach a mounting clamp directly. Mounting clamps are sold separately. Make sure the clamps are capable of supporting the weight of this product. Use at least one mounting point per product. For the CHAUVET Professional line of mounting clamps, go to <http://www.trusst.com/products>.

### Mounting Diagram

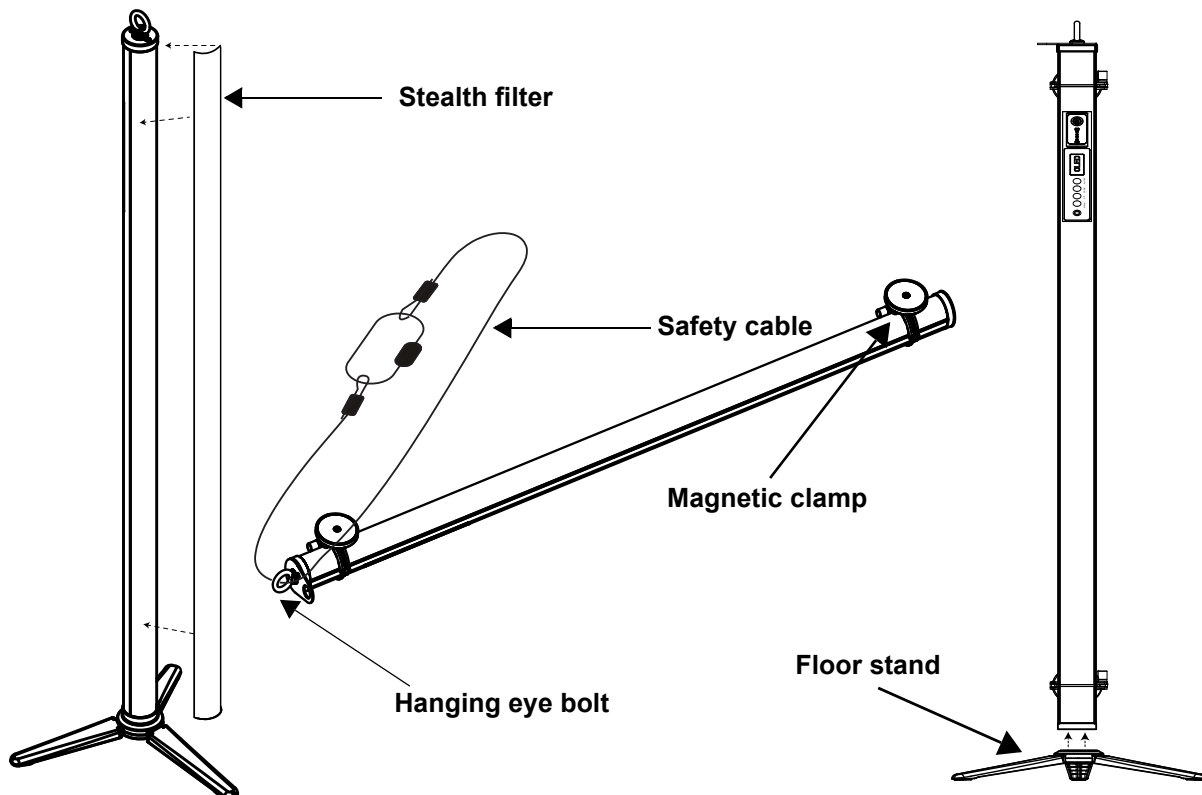

### Stealth Filter

The WELL STX 180 comes with black stealth filters that allow the product to become invisible when it is turned off and is in front of a dark background. The stealth filter easily snaps to the WELL STX 180 for quick installation and removal.

## 4. Operation

### Control Panel Operation

Button	Function
<MENU>	Exits from the current menu or function
<ENTER>	Enables the currently displayed menu or sets the currently selected value in to the current function
<UP>	Navigates upward through the menu list or increases the numeric value when in a function
<DOWN>	Navigates downward through the menu list or decreases the numeric value when in a function

### Control Options

Set the WELL STX 180 starting address in the 001-512 DMX range. This enables control of up to 11 products in the 67-channel personality.

### Programming

Refer to the [Menu Map](#) to understand the menu options. The menu map shows the main level and a variable number of programming levels for each option.

- To go to the desired main level, press <MENU> repeatedly until the option shows on the display. Press <ENTER> to select. This will show the first programming level for that option.
- To select an option or value within the current programming level, press <UP> or <DOWN> until the option shows on the display. Press <ENTER> to select. This will show either the first option if there is another programming level, or the selected value.
- Press <MENU> repeatedly to exit to the previous main level.

### Control Panel Lock

The setting locks or unlocks the control panel.

1. Go to the **Key Lock** main level.
2. Select **On** (locks control panel) or **Off** (control panel stays unlocked).



**When the control panel lock is activated, the product will prompt for the passcode to access the menu. To enter the passcode, press: <UP>, <DOWN>, <UP>, <DOWN>, <ENTER>.**

### Configuration (DMX)

Use DMX configurations to operate the product with a DMX controller.

#### DMX Personalities

This setting allows the user to choose a particular DMX personality.

1. Go to the **DMX Personality** main level.
2. Select the desired personality (**4Ch**, **15Ch**, **64Ch**, or **67Ch**).



- See the [Starting Address](#) section for the highest starting address suggested for each personality.
- Make sure that the starting addresses on the various products do not overlap due to the new personality setting.

### Starting Address

In this mode, each product will respond to a unique starting address from the DMX controller. All products with the same starting address will respond in unison.

1. Go to the **DMX Address** main level.
2. Set the starting address (**001–512**).

The highest recommended starting address for each DMX mode is as follows:

DMX Personality	DMX Address
<b>4Ch</b>	<b>509</b>
<b>15Ch</b>	<b>498</b>
<b>64Ch</b>	<b>449</b>
<b>67Ch</b>	<b>446</b>

## Operation

### Menu Map

Refer to the WELL STX 180 product page on [www.chauvetprofessional.com](http://www.chauvetprofessional.com) for the latest menu map.

Main Level	Programming Levels		Description																																		
<b>DMX Address</b>	<b>001–512</b>		Selects DMX address (highest channel restricted to personality chosen)																																		
<b>DMX Channel</b>	<b>4Ch</b>		4-channel: RGBW																																		
	<b>15Ch</b>		15-channel: RGBW, color temperature, strobe, auto programs, auto speed, foreground color dimmer, foreground color, background color dimmer, background color, dimmer speed, auto delay																																		
	<b>64Ch</b>		64-channel: RGBW 1–16																																		
	<b>67Ch</b>		67-channel: RGBW 1–16, strobe, dimmer, dimmer speed																																		
<b>Static</b>	<b>Manual Color</b>	<table border="1"> <tr><td>R</td></tr> <tr><td>G</td></tr> <tr><td>B</td></tr> <tr><td>W</td></tr> </table> <b>000–255</b>	R	G	B	W	Manually adjusts RGBW color settings																														
	R																																				
G																																					
B																																					
W																																					
<b>Color Temperature</b>	<table border="1"> <tr><td>2800K</td></tr> <tr><td>2900K</td></tr> <tr><td>3000K</td></tr> <tr><td>3100K</td></tr> <tr><td>3200K</td></tr> <tr><td>3300K</td></tr> <tr><td>3400K</td></tr> <tr><td>3500K</td></tr> <tr><td>3600K</td></tr> <tr><td>3700K</td></tr> <tr><td>3800K</td></tr> <tr><td>3900K</td></tr> <tr><td>4000K</td></tr> <tr><td>4100K</td></tr> <tr><td>4200K</td></tr> <tr><td>4300K</td></tr> <tr><td>4400K</td></tr> <tr><td>4500K</td></tr> <tr><td>4600K</td></tr> <tr><td>4700K</td></tr> <tr><td>4800K</td></tr> <tr><td>4900K</td></tr> <tr><td>5000K</td></tr> <tr><td>5100K</td></tr> <tr><td>5200K</td></tr> <tr><td>5300K</td></tr> <tr><td>5400K</td></tr> <tr><td>5500K</td></tr> <tr><td>5600K</td></tr> <tr><td>5700K</td></tr> <tr><td>6000K</td></tr> <tr><td>6500K</td></tr> <tr><td>7000K</td></tr> <tr><td>7500K</td></tr> <tr><td>8000K</td></tr> </table>	2800K	2900K	3000K	3100K	3200K	3300K	3400K	3500K	3600K	3700K	3800K	3900K	4000K	4100K	4200K	4300K	4400K	4500K	4600K	4700K	4800K	4900K	5000K	5100K	5200K	5300K	5400K	5500K	5600K	5700K	6000K	6500K	7000K	7500K	8000K	Selects preset color temperature
2800K																																					
2900K																																					
3000K																																					
3100K																																					
3200K																																					
3300K																																					
3400K																																					
3500K																																					
3600K																																					
3700K																																					
3800K																																					
3900K																																					
4000K																																					
4100K																																					
4200K																																					
4300K																																					
4400K																																					
4500K																																					
4600K																																					
4700K																																					
4800K																																					
4900K																																					
5000K																																					
5100K																																					
5200K																																					
5300K																																					
5400K																																					
5500K																																					
5600K																																					
5700K																																					
6000K																																					
6500K																																					
7000K																																					
7500K																																					
8000K																																					

Main Level	Programming Levels		Description	
Static (cont.)	Fixed color	<b>R</b>	Red	
		<b>G</b>	Green	
		<b>B</b>	Blue	
		<b>W</b>	White	
		<b>GB</b>	Green + blue	
		<b>RB</b>	Red + blue	
		<b>RG</b>	Red + green	
		<b>RGB</b>	Red + green + blue	
		<b>RW</b>	Red + white	
		<b>GW</b>	Green + white	
		<b>BW</b>	Blue + white	
		<b>RGW</b>	Red + green + white	
		<b>RBW</b>	Red + blue + white	
		<b>GBW</b>	Green + blue + white	
	<b>RGBW</b>	Red + green + blue + white		
Auto Show	Auto 1–28	Foreground	<b>R</b>	Red
			<b>G</b>	Green
			<b>B</b>	Blue
			<b>W</b>	White
			<b>GB</b>	Green + blue
			<b>RB</b>	Red + blue
			<b>RG</b>	Red + green
			<b>RGB</b>	Red + green + blue
			<b>RW</b>	Red + white
			<b>GW</b>	Green + white
			<b>BW</b>	Blue + white
			<b>RGW</b>	Red + green + white
			<b>RBW</b>	Red + blue + white
			<b>GBW</b>	Green + blue + white
			<b>RGBW</b>	Red + green + blue + white
			<b>2800K</b>	2800K white
			<b>7000K</b>	7000K white
			<b>Auto</b>	Auto colors
<b>Off</b>	No foreground color			

# Operation



Main Level	Programming Levels		Description	
Auto Show	Auto 1–28	Background	<b>R</b>	Red
			<b>G</b>	Green
			<b>B</b>	Blue
			<b>W</b>	White
			<b>GB</b>	Green + blue
			<b>RB</b>	Red + blue
			<b>RG</b>	Red + green
			<b>RGB</b>	Red + green + blue
			<b>RW</b>	Red + white
			<b>GW</b>	Green + white
			<b>BW</b>	Blue + white
			<b>RGW</b>	Red + green + white
			<b>RBW</b>	Red + blue + white
			<b>GBW</b>	Green + blue + white
			<b>RGBW</b>	Red + green + blue + white
			<b>2800K</b>	2800K white
			<b>7000K</b>	7000K white
	<b>Auto</b>	Auto colors		
<b>Off</b>	No background color			
	<b>Speed</b>	<b>1–100</b>	Adjusts speed of auto programs	
Wireless Setting	<b>W-DMX On/Off</b>		<b>On</b>	Turns wireless DMX mode on/off
			<b>Off</b>	
	<b>Receive Reset</b> (Only in Receive mode)		<b>No</b>	Resets the internal receiver
			<b>Yes</b>	
	<b>Link</b> (Only in Transmit mode)		<b>Link</b>	Links or unlinks to a W-DMX receiver
			<b>Unlink</b>	
<b>Operating Mode</b>		<b>Receive</b>	Receives W-DMX	
		<b>Transmit</b>	Transmits W-DMX	
White Balance	<b>Off</b>		Turns off white balance	
	Manual	<b>R</b>	<b>125–255</b>	Adjusts the red, green, blue, and white LED maximum values manually
		<b>G</b>		
		<b>B</b>		
		<b>W</b>		
IR Setting	<b>On</b>		Turns on infrared mode for IRC-6 remote use	
	<b>Off</b>			
Run Time	<b>3 hours</b>		Shows product run time	
	<b>5 hours</b>			
	<b>8 hours</b>			
	<b>12 hours</b>			
Dimmer Mode	<b>Off</b>		Dimmer off	
	<b>Dimmer 1–3</b>		Dimming curves <b>Dimmer 1</b> (fast) to <b>Dimmer 3</b> (slow)	
Back Light	<b>10S</b>		Turns off display backlight after 10 seconds of inactivity	
	<b>30S</b>		Turns off display backlight after 30 seconds of inactivity	
	<b>2min</b>		Turns off display backlight after 2 minutes of inactivity	
	<b>Always On</b>		Display backlight always on	
Key lock	<b>On</b>		Locks/unlocks the display	
	<b>Off</b>		(Password is: <UP>, <DOWN>, <UP>, <DOWN>, <ENTER>)	

Main Level	Programming Levels		Description
Information	Fixture Hours	----H	Shows total hours the product has been powered on
	LED Hours	----H	Shows total LED hours
	Version	V_ _	Shows current firmware version
	UID	-----	Shows product UID
Factory Reset	No		Resets the product to factory default settings
	Yes		

## DMX Values

### 67Ch

Channel	Function	Value	Percent/Setting
1	Red 1	000 ⇔ 255	0–100%
2	Green 1	000 ⇔ 255	0–100%
3	Blue 1	000 ⇔ 255	0–100%
4	White 1	000 ⇔ 255	0–100%
5	Red 2	000 ⇔ 255	0–100%
6	Green 2	000 ⇔ 255	0–100%
7	Blue 2	000 ⇔ 255	0–100%
8	White 2	000 ⇔ 255	0–100%
9	Red 3	000 ⇔ 255	0–100%
10	Green 3	000 ⇔ 255	0–100%
11	Blue 3	000 ⇔ 255	0–100%
12	White 3	000 ⇔ 255	0–100%
13	Red 4	000 ⇔ 255	0–100%
14	Green 4	000 ⇔ 255	0–100%
15	Blue 4	000 ⇔ 255	0–100%
16	White 4	000 ⇔ 255	0–100%
17	Red 5	000 ⇔ 255	0–100%
18	Green 5	000 ⇔ 255	0–100%
19	Blue 5	000 ⇔ 255	0–100%
20	White 5	000 ⇔ 255	0–100%
21	Red 6	000 ⇔ 255	0–100%
22	Green 6	000 ⇔ 255	0–100%
23	Blue 6	000 ⇔ 255	0–100%
24	White 6	000 ⇔ 255	0–100%
25	Red 7	000 ⇔ 255	0–100%
26	Green 7	000 ⇔ 255	0–100%
27	Blue 7	000 ⇔ 255	0–100%
28	White 7	000 ⇔ 255	0–100%
29	Red 8	000 ⇔ 255	0–100%
30	Green 8	000 ⇔ 255	0–100%
31	Blue 8	000 ⇔ 255	0–100%
32	White 8	000 ⇔ 255	0–100%
33	Red 9	000 ⇔ 255	0–100%
34	Green 9	000 ⇔ 255	0–100%
35	Blue 9	000 ⇔ 255	0–100%
36	White 9	000 ⇔ 255	0–100%
37	Red 10	000 ⇔ 255	0–100%



## Operation

Channel	Function	Value	Percent/Setting
38	Green 10	000 ⇔ 255	0–100%
39	Blue 10	000 ⇔ 255	0–100%
40	White 10	000 ⇔ 255	0–100%
41	Red 11	000 ⇔ 255	0–100%
42	Green 11	000 ⇔ 255	0–100%
43	Blue 11	000 ⇔ 255	0–100%
44	White 11	000 ⇔ 255	0–100%
45	Red 12	000 ⇔ 255	0–100%
46	Green 12	000 ⇔ 255	0–100%
47	Blue 12	000 ⇔ 255	0–100%
48	White 12	000 ⇔ 255	0–100%
49	Red 13	000 ⇔ 255	0–100%
50	Green 13	000 ⇔ 255	0–100%
51	Blue 13	000 ⇔ 255	0–100%
52	White 13	000 ⇔ 255	0–100%
53	Red 14	000 ⇔ 255	0–100%
54	Green 14	000 ⇔ 255	0–100%
55	Blue 14	000 ⇔ 255	0–100%
56	White 14	000 ⇔ 255	0–100%
57	Red 15	000 ⇔ 255	0–100%
58	Green 15	000 ⇔ 255	0–100%
59	Blue 15	000 ⇔ 255	0–100%
60	White 15	000 ⇔ 255	0–100%
61	Red 16	000 ⇔ 255	0–100%
62	Green 16	000 ⇔ 255	0–100%
63	Blue 16	000 ⇔ 255	0–100%
64	White 16	000 ⇔ 255	0–100%
65	Strobe	000 ⇔ 010 011 ⇔ 255	Off Strobe, slow to fast
66	Dimmer	000 ⇔ 255	0–100%
67	Dimmer speed	000 ⇔ 051 052 ⇔ 101 102 ⇔ 152 153 ⇔ 203 204 ⇔ 255	Preset dimmer speed from display menu Dimmer speed mode off Dimmer speed mode 1 (fastest) Dimmer speed mode 2 Dimmer speed mode 3 (slowest)

64Ch

Channel	Function	Value	Percent/Setting
1	Red 1	000 ⇔ 255	0–100%
2	Green 1	000 ⇔ 255	0–100%
3	Blue 1	000 ⇔ 255	0–100%
4	White 1	000 ⇔ 255	0–100%
5	Red 2	000 ⇔ 255	0–100%
6	Green 2	000 ⇔ 255	0–100%
7	Blue 2	000 ⇔ 255	0–100%
8	White 2	000 ⇔ 255	0–100%
9	Red 3	000 ⇔ 255	0–100%
10	Green 3	000 ⇔ 255	0–100%
11	Blue 3	000 ⇔ 255	0–100%
12	White 3	000 ⇔ 255	0–100%
13	Red 4	000 ⇔ 255	0–100%
14	Green 4	000 ⇔ 255	0–100%
15	Blue 4	000 ⇔ 255	0–100%
16	White 4	000 ⇔ 255	0–100%
17	Red 5	000 ⇔ 255	0–100%
18	Green 5	000 ⇔ 255	0–100%
19	Blue 5	000 ⇔ 255	0–100%
20	White 5	000 ⇔ 255	0–100%
21	Red 6	000 ⇔ 255	0–100%
22	Green 6	000 ⇔ 255	0–100%
23	Blue 6	000 ⇔ 255	0–100%
24	White 6	000 ⇔ 255	0–100%
25	Red 7	000 ⇔ 255	0–100%
26	Green 7	000 ⇔ 255	0–100%
27	Blue 7	000 ⇔ 255	0–100%
28	White 7	000 ⇔ 255	0–100%
29	Red 8	000 ⇔ 255	0–100%
30	Green 8	000 ⇔ 255	0–100%
31	Blue 8	000 ⇔ 255	0–100%
32	White 8	000 ⇔ 255	0–100%
33	Red 9	000 ⇔ 255	0–100%
34	Green 9	000 ⇔ 255	0–100%
35	Blue 9	000 ⇔ 255	0–100%
36	White 9	000 ⇔ 255	0–100%
37	Red 10	000 ⇔ 255	0–100%
38	Green 10	000 ⇔ 255	0–100%
39	Blue 10	000 ⇔ 255	0–100%
40	White 10	000 ⇔ 255	0–100%
41	Red 11	000 ⇔ 255	0–100%
42	Green 11	000 ⇔ 255	0–100%
43	Blue 11	000 ⇔ 255	0–100%
44	White 11	000 ⇔ 255	0–100%
45	Red 12	000 ⇔ 255	0–100%
46	Green 12	000 ⇔ 255	0–100%
47	Blue 12	000 ⇔ 255	0–100%
48	White 12	000 ⇔ 255	0–100%
49	Red 13	000 ⇔ 255	0–100%

## Operation

Channel	Function	Value	Percent/Setting
50	Green 13	000 ⇔ 255	0–100%
51	Blue 13	000 ⇔ 255	0–100%
52	White 13	000 ⇔ 255	0–100%
53	Red 14	000 ⇔ 255	0–100%
54	Green 14	000 ⇔ 255	0–100%
54	Green 14	000 ⇔ 255	0–100%
55	Blue 14	000 ⇔ 255	0–100%
56	White 14	000 ⇔ 255	0–100%
57	Red 15	000 ⇔ 255	0–100%
58	Green 15	000 ⇔ 255	0–100%
59	Blue 15	000 ⇔ 255	0–100%
60	White 15	000 ⇔ 255	0–100%
61	Red 16	000 ⇔ 255	0–100%
62	Green 16	000 ⇔ 255	0–100%
63	Blue 16	000 ⇔ 255	0–100%
64	White 16	000 ⇔ 255	0–100%

## 15Ch

Channel	Function	Value	Percent/Setting
1	Dimmer	000 ⇔ 255	0–100%
2	Red	000 ⇔ 255	0–100%
3	Green	000 ⇔ 255	0–100%
4	Blue	000 ⇔ 255	0–100%
5	White	000 ⇔ 255	0–100%
6	Color temperature	000 ⇔ 255	See <a href="#">Color Temperature Chart</a>
7	Strobe	000 ⇔ 010 011 ⇔ 255	No function Strobe, slow to fast
8	Auto programs	000 ⇔ 010 011 ⇔ 018 019 ⇔ 026 027 ⇔ 034 035 ⇔ 042 043 ⇔ 050 051 ⇔ 058 059 ⇔ 066 067 ⇔ 074 075 ⇔ 082 083 ⇔ 090 091 ⇔ 098 099 ⇔ 106 107 ⇔ 114 115 ⇔ 122 123 ⇔ 130 131 ⇔ 138 139 ⇔ 146 147 ⇔ 154 155 ⇔ 162 163 ⇔ 170 171 ⇔ 178	No function Program 1 Program 2 Program 3 Program 4 Program 5 Program 6 Program 7 Program 8 Program 9 Program 10 Program 11 Program 12 Program 13 Program 14 Program 15 Program 16 Program 17 Program 18 Program 19 Program 20 Program 21

Channel	Function	Value	Percent/Setting
8	Auto programs (cont.)	179 ⇔ 186	Program 22
		187 ⇔ 194	Program 23
		195 ⇔ 202	Program 24
		203 ⇔ 210	Program 25
		211 ⇔ 218	Program 26
		219 ⇔ 226	Program 27
		227 ⇔ 255	Program 28 (cycles through programs 1–27)
9	Auto speed	000 ⇔ 255	Auto programs speed, slow to fast
10	Foreground color dimmer	000 ⇔ 255	0–100%
11	Foreground color	000 ⇔ 013	Red
		014 ⇔ 027	Green
		028 ⇔ 041	Blue
		042 ⇔ 055	White
		056 ⇔ 069	Green + blue
		070 ⇔ 083	Red + blue
		084 ⇔ 097	Red + green
		098 ⇔ 111	Red + green + blue
		112 ⇔ 125	Red + white
		126 ⇔ 139	Green + white
		140 ⇔ 153	Blue + white
		154 ⇔ 167	Red + green + white
		168 ⇔ 181	Red + blue + white
		182 ⇔ 195	Green + blue + white
		196 ⇔ 209	Red + green + blue + white
210 ⇔ 223	2800K		
224 ⇔ 237	7000K		
238 ⇔ 255	Auto		
12	Background color dimmer	000 ⇔ 255	0–100%
13	Background color	000 ⇔ 013	Red
		014 ⇔ 027	Green
		028 ⇔ 041	Blue
		042 ⇔ 055	White
		056 ⇔ 069	Green + blue
		070 ⇔ 083	Red + blue
		084 ⇔ 097	Red + green
		098 ⇔ 111	Red + green + blue
		112 ⇔ 125	Red + white
		126 ⇔ 139	Green + white
		140 ⇔ 153	Blue + white
		154 ⇔ 167	Red + green + white
		168 ⇔ 181	Red + blue + white
		182 ⇔ 195	Green + blue + white
		196 ⇔ 209	Red + green + blue + white
210 ⇔ 223	2800K		
224 ⇔ 237	7000K		
238 ⇔ 255	Auto		

## Operation

Channel	Function	Value	Percent/Setting
14	Dimmer speed mode	000 ⇔ 051	Preset dimmer speed from display menu
		052 ⇔ 101	Dimmer speed mode off
		102 ⇔ 152	Dimmer speed mode 1 (fastest)
		153 ⇔ 203	Dimmer speed mode 2
		204 ⇔ 255	Dimmer speed mode 3 (slowest)
15	Auto delay	000 ⇔ 255	0–100%

## 4Ch

Channel	Function	Value	Percent/Setting
1	Red	000 ⇔ 255	0–100%
2	Green	000 ⇔ 255	0–100%
3	Blue	000 ⇔ 255	0–100%
4	White	000 ⇔ 255	0–100%

## Color Temperature Chart

DMX Value	Display Readout	DMX Value	Display Readout
000 ⇔ 005	No function	125 ⇔ 131	4500K
006 ⇔ 012	2800K	132 ⇔ 138	4600K
013 ⇔ 019	2900K	139 ⇔ 145	4700K
020 ⇔ 026	3000K	146 ⇔ 152	4800K
027 ⇔ 033	3100K	153 ⇔ 159	4900K
034 ⇔ 040	3200K	160 ⇔ 166	5000K
041 ⇔ 047	3300K	167 ⇔ 173	5100K
048 ⇔ 054	3400K	174 ⇔ 180	5200K
055 ⇔ 061	3500K	181 ⇔ 187	5300K
062 ⇔ 068	3600K	188 ⇔ 194	5400K
069 ⇔ 075	3700K	195 ⇔ 201	5500K
076 ⇔ 082	3800K	202 ⇔ 208	5600K
083 ⇔ 089	3900K	209 ⇔ 215	5700K
090 ⇔ 096	4000K	216 ⇔ 222	6000K
097 ⇔ 103	4100K	223 ⇔ 229	6500K
104 ⇔ 110	4200K	230 ⇔ 236	7000K
111 ⇔ 117	4300K	237 ⇔ 243	7500K
118 ⇔ 124	4400K	244 ⇔ 255	8000K

## Configuration (Standalone)

Use standalone configuration to operate the product without a DMX controller.

### Static Mode

#### Manual Color Mixer

To do color mixing without a DMX controller, follow the instructions below:

1. Go to the **Static** main level.
2. Select **Manual Color**.
3. Select which **RGBW** color to adjust.
4. Set color value from **000–255**.

#### Color Temperature

To select a preset color temperature, do the following:

1. Go to the **Static** main level.
2. Select **Color Temperature**.
3. Select the desired color temperature, from **2800K** to **8000K**.

#### Fixed Color

To select a single or combination RGBW color, follow the instructions below:

1. Go to the **Static** main level.
2. Select **Fixed Color**.
3. Select a single RGBW color or an RGBW color combination.

#### Auto Programs

To select which auto program to display, do the following:

1. Go to the **Auto Show** main level.
2. Select the desired auto program, from **Auto 1–28**.
3. Select between **Foreground** (sets what foreground color to display) and **Background** (sets what background color to display).
4. Select among **RGBW** color or color combinations, **2800K**, **7000K**, **Auto** (automatic colors), or **Off** (no foreground or background color).



**The auto programs cannot be edited.**

#### Auto Program Speed

To adjust the speed of the auto programs, follow the instructions below:

1. Go to the **Auto Show** main level.
2. Select the desired auto program, from **Auto 1–28**.
3. Select **Speed**.
4. Select the speed of auto programs, from **1** (slowest) to **100** (fastest).

#### White Balance

To set the maximum values of a given LED color to create a white light output, do the following:

1. Go to the **White Balance** main level.
2. Select **Off** (to use factory default white setting) or **Manual** (to customize the white balance).
  - a. Select the desired color (**RGBW**).
  - b. Set the desired value for the selected color (**125–255**).
  - c. Repeat steps a–b until the static color is set as desired.

#### Run Time

To lessen the product output to maximize the product run time, follow the instructions below:

1. Go to the **Run Time** main level.
2. Select the desired product run time (**3**, **5**, **8**, and **12 hours**).

#### Back Light

To select the amount of time the back light on the WELL STX 180's display stays on after the last button is pressed on the control panel, do the following:

1. Go to the **RBack Light** main level.
2. Select **Always On** (remains On), **10S** (10 seconds), **30S** (30 seconds), or **2min** (2 minutes).

## Operation

### Dimmer Profiles

This setting provides four different options to simulate the dimming curve of an incandescent lighting product. To set how fast the output of the WELL STX 180 changes when the output value is modified, do the following:

1. Go to the **Dimmer Mode** main level.
2. Select a dimmer curve (**Off**, **Dimmer 1**, **Dimmer 2**, or **Dimmer 3**).



**Off:** The output is proportional (linear) to the dimmer channel value.

**Dimmer 1–3:** The output follows the dimmer value based on the corresponding dimmer curve, DIM1 being the fastest.

### System Information

To display the total number of hours the product has run, the total LED hours, the installed software version, and the product's UID, follow the instructions below:

1. Go to the **Information** main level.
2. Select **Fixture Hours**, **LED Hours**, **Version**, or **UID**.

### Factory Reset

To restore the WELL STX 180 to factory default settings, do the following:

1. Go to the **Factory Reset** main level.
2. Select **No** (do not reset) or **Yes** (reset to factory default settings).

### Master/Slave Mode

The Master/Slave mode allows a group of WELL STX 180 products (the slaves) to simultaneously duplicate the output of another WELL STX 180 (the master) without a DMX controller. To set each of the slaves:

1. Go to **Wireless Setting > W-DMX On/Off**.
2. Select **On**.
3. Go to **Wireless Setting > Operating Mode**.
4. Select **Receive**.
5. Go to **Wireless Setting > Receive Reset**.
6. Select **Yes**.

To set the master:

1. Go to **Wireless Setting > W-DMX On/Off**.
2. Select **On**.
3. Go to **Wireless Setting > Operating Mode**.
4. Select **Transmit**.
5. Go to **Wireless Setting > Link**.
6. Select **Link** to link to the slave products.
7. Select a standalone setting, or control with the IR remote.



- **The master is the one that runs a program whether in Auto, Static, or IR mode.**
- **Do not connect a DMX controller to the products configured for Master/Slave operation. The DMX controller may interfere with signals from the master.**
- **Do not connect a WDMX transmitter to the products configured for Master/Slave operation. The WDMX transmitter may interfere with signals from the master.**

## Infrared Remote Control

Infrared (IR) mode allows the product to be controlled with an infrared remote control. The IR remote can remotely set the product to various modes; adjust the color, speed, and sensitivity; and set the strobe. The WELL STX 180 is compatible with the IR remote (sold separately) from Chauvet.



It may be necessary to turn the product off and on again when switching from W-DMX to IRC and vice versa.

## IR Remote Operation

Ensure that the IR remote is pointing directly at the product, and there is nothing in between the remote and the product.

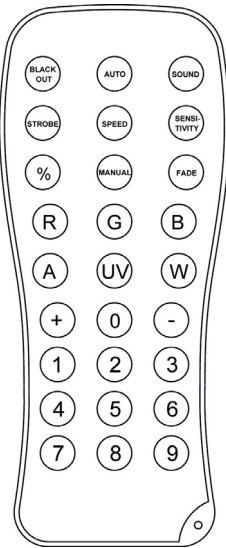

### Automatic Mode

Automatic mode will enable the automatic programs on the product. To turn on Automatic mode:

1. Press **<AUTO>** on the IR remote.
2. Press **<+>** or **<->** to choose between the 28 auto programs.

To adjust the speed of the automatic program:

1. Press **<SPEED>** on the IR remote.
2. Press **<+>** or **<->** to increase or decrease the speed.

### Manual Color Control

To choose a specific color with the IR remote, press any number between **<0>** and **<9>**. To manually control the RGBW percentage:

1. Press **<MANUAL>** on the IR remote.
2. Press **<R>**, **<G>**, **<B>**, or **<W>** (red, green, blue, or white) to choose a color.
3. Press **<+>** or **<->** to increase or decrease the value of the selected color.

### Miscellaneous Operation

To black out the lights:

- Press **<BLACKOUT>** on the IR remote. This will turn off all the lights until the button is pressed again.

To adjust the output level:

1. Press **<%>** on the IR remote.
2. Press **<+>** or **<->** to increase or decrease the output level.

**Note:** The IR remote will not respond to any inputs when the Black Out mode is activated. If the remote does not respond when a button is pressed, try pressing **<BLACK OUT>**. You may have inadvertently activated the Black Out mode.



## 5. Technical Information

### Product Maintenance

To maintain optimum performance and minimize wear, clean this product frequently. Usage and environment are contributing factors in determining the cleaning frequency.

Clean this product at least twice a month. Dust build-up reduces light output performance and can cause overheating. This can lead to reduced light source life and increased mechanical wear.

To clean the product:

1. Unplug the product from power.
2. Wait until the product is at room temperature.
3. Use a vacuum (or dry compressed air) and a soft brush to remove dust collected on the external vents.
4. Clean all surfaces with a mild soap solution, ammonia-free glass cleaner, or isopropyl alcohol.
5. Apply the solution directly to a soft, lint free cotton cloth or a lens cleaning tissue.
6. Softly drag any dirt or grime to the outside of the transparent surface.
7. Gently polish the transparent surfaces until they are free of haze and lint.



**Always dry the transparent surfaces carefully after cleaning them.**



**Avoid spinning the cooling fans using compressed air to prevent damage.**

## 6. Technical Specifications

### Dimensions and Weight

Length	Width	Height	Weight
39.3 in (1000 mm)	1.6 in (42.4 mm)	1.6 in (42.4 mm)	3.4 lb (1.5 kg)

**Note:** Dimensions in inches rounded to the nearest decimal digit.

### Power

Power Supply Type	Range	Voltage Selection
Switching (internal)	100 to 240 VAC, 50/60 Hz	Auto-ranging

Parameter	120 V, 60 Hz	208 V, 60 Hz	230 V, 50 Hz
Consumption (single unit charging)	33 W	42 W	44 W
Consumption (charging case)	198 W	252 W	264 W
Operating current (single unit charging)	0.27 A	0.20 A	0.19 A
Operating current (charging case)	1.62 A	1.2 A	1.14 A
Power-linking products	8 products	11 products	11 products

Power I/O	U.S./Worldwide	UK/Europe
Power input connector	Seetronic Powerkon IP65	Seetronic Powerkon IP65
Power output connector	Seetronic Powerkon IP65	Seetronic Powerkon IP65
Power cord plug	Edison (U.S.)	Local plug

### Battery

Battery Type	Battery Charge	Battery Life	Battery Power
Lithium ion	6 hours	3-, 5-, 8-, or 12-hour settings	14.8 V, 6.7 Ah

### Light Source

Type	Color	Quantity	Power	Current	Lifespan
LED	RGB Warm white	64 64	45 W	3.0 A	50,000 hours

### Photometrics

Parameter	Total Value	Parameter	Total Value
Beam horizontal angle	126°	Color temperature (range)	2800K to 8000K
Beam vertical angle	125°	Color temperature (full)	9936K
Field horizontal angle	214°	Illuminance (total)	17 lux @ 5m (3 hour runtime)
Field vertical angle	210°		

### Thermal

#### Maximum External Temperature

113 °F (45 °C)

### DMX

I/O Connector	Channel Range
W-DMX	4, 15, 64, or 67 channels

### Ordering

Product Name	Item Name	Item Code	UPC Number
WELL STX 180	WELLSTX180X6	03031686	781462220341



UL 1573  
CSA C22.2 No. 166  
E113093



## Returns

---

### Returns

Send the product prepaid, in the original box, and with the original packing and accessories. Chauvet will not issue call tags.

Call Chauvet and request a Return Merchandise Authorization (RMA) number before shipping the product. Be prepared to provide the model number, serial number, and a brief description of the cause(s) for the return.

To submit a service request online, go to [www.chauvetprofessional.com/service-request](http://www.chauvetprofessional.com/service-request).

Clearly label the package with an RMA number. Chauvet will refuse any product returned without an RMA number.



**Write the RMA number on a properly affixed label. DO NOT write the RMA number directly on the box.**

Once you have the RMA number, provide the following information on a piece of paper and place it inside the box:

- Your name
- Your address
- Your phone number
- RMA number
- A brief description of the problem

Be sure to pack the product properly. Any shipping damage resulting from inadequate packaging will be your responsibility. FedEx packing or double-boxing are recommended.



**Chauvet reserves the right to use its own discretion to repair or replace returned product(s).**

## Contact Us

General Information	Technical Support
<b>Chauvet World Headquarters</b>	
Address: 5200 NW 108th Ave. Sunrise, FL 33351 Voice: (954) 577-4455 Fax: (954) 929-5560 Toll Free: (800) 762-1084	Voice: (844) 393-7575 Fax: (954) 756-8015 Email: <a href="mailto:chauvetcs@chauvetlighting.com">chauvetcs@chauvetlighting.com</a> Website: <a href="http://www.chauvetprofessional.com">www.chauvetprofessional.com</a>
<b>Chauvet Europe Ltd</b>	
Address: Unit 1C Brookhill Road Industrial Estate Pinxton, Nottingham, UK NG16 6NT Voice: +44 (0) 1773 511115 Fax: +44 (0) 1773 511110	Email: <a href="mailto:UKtech@chauvetlighting.eu">UKtech@chauvetlighting.eu</a> Website: <a href="http://www.chauvetprofessional.eu">www.chauvetprofessional.eu</a>
<b>Chauvet Europe BVBA</b>	
Address: Stokstraat 18 9770 Kruishoutem Belgium Voice: +32 9 388 93 97	Email: <a href="mailto:BNLtech@chauvetlighting.eu">BNLtech@chauvetlighting.eu</a> Website: <a href="http://www.chauvetprofessional.eu">www.chauvetprofessional.eu</a>
<b>Chauvet France</b>	
Address: 3, Rue Ampère 91380 Chilly-Mazarin France Voice: +33 1 78 85 33 59	Email: <a href="mailto:FRtech@chauvetlighting.fr">FRtech@chauvetlighting.fr</a> Website: <a href="http://www.chauvetprofessional.eu">www.chauvetprofessional.eu</a>
<b>Chauvet Germany</b>	
Address: Bruno-Bürgel-Str. 11 28759 Bremen Germany Voice: +49 421 62 60 20	Email: <a href="mailto:DEtech@chauvetlighting.de">DEtech@chauvetlighting.de</a> Website: <a href="http://www.chauvetprofessional.eu">www.chauvetprofessional.eu</a>
<b>Chauvet Mexico</b>	
Address: Av. de las Partidas 34 - 3B (Entrance by Calle 2) Zona Industrial Lerma Lerma, Edo. de México, CP 52000 Voice: +52 (728) 690-2010	Email: <a href="mailto:servicio@chauvet.com.mx">servicio@chauvet.com.mx</a> Website: <a href="http://www.chauvetprofessional.mx">www.chauvetprofessional.mx</a>

Visit the applicable website above to verify our contact information and instructions to request support. Outside the U.S., U.K., Ireland, Benelux, France, Germany, or Mexico, contact the dealer of record.