

PHOTOMETRICS REPORT
OVATION
F-915FC



Table of Contents

1. Testing Process	1
2. Photometric Reports	2
Full Flood, Full Power	2
Report Summary	2
Overall Measurement	2
Beam Details	3
Polar Diagrams	4
50% Zoom, Full Power	5
Report Summary	5
Overall Measurement	5
Beam Details	6
Polar Diagrams	7
Full Spot, Full Power	8
Report Summary	8
Overall Measurement	8
Beam Details	9
Polar Diagrams	10
3. Chromaticity Reports	11
3200K	11
Report Summary	11
Chromaticity	12
TM-30-18 Details	13
5600K	14
Report Summary	14
Chromaticity	15
TM-30-18 Details	16
4. Contact Us	17

Testing Process

Total Illuminance Measurements

Illuminance is measured using the Viso Systems LabSpion[®], which takes multiple measurements across a light beam to calculate the total delivered lumens, beam, and field of a product. These values can be described as the empirical output of the product as it projects from the lens or lenses. All photometric data contained in this report are obtained from the actual illuminance of the tested Chauvet light source and are never theoretical values derived from calculations.

Testing Lab Equipment and Process

The Chauvet headquarters in Sunrise, Florida has a climate- and light-controlled photometric testing laboratory where Chauvet products are analyzed and photometric data are measured using the Viso Systems LabSpion[®] light measurement solution.

This system includes a spectrometer sensor, which measures the precise light and color output of the fixture, and a two-axis goniometer, which rotates the product to allow for multi-angle and multi-directional measurement. The Viso Light Inspector software then collects and summarizes the data. From the data gathered, the software can also measure the beam and field angles, accurate color temperature, color quality, and illuminance at multiple distances. The custom-built, Chauvet-specific template presents this information in the photometric and chromaticity reports that follow.

IES (Illuminating Engineering Society) files, an industry-standard file format, are also generated from each test for easy distribution of photometric data.

Several light meters are also used for specific products or to recheck for precision. Accuracy is verified using one or more of the devices listed below:

- Sekonic SpectroMaster C-700-U
- EXTECH HD450 Datalogging Heavy Duty Light Meter
- Asensetek Essence Lighting Passport

To ensure accurate measurements in every photometric or chromaticity test, Chauvet routinely calibrates the LabSpion[®] system every six months as recommended by Viso Systems.

Photometric Report

Ovation F-915FC: Full Flood, Full Power

Report Summary

Output

Total Lumens: 7950 lm
Peak Intensity: 9812 cd
Illuminance @ 5m: 392 lux
Fixture Efficacy: 26 lm/W

Optical

Horizontal Beam Angle (50%): 52.3°
Vertical Beam Angle (50%): 52.4°
Horizontal Field Angle (10%): 84.3°
Vertical Field Angle (10%): 84.3°
Horizontal Cutoff Angle (3%): 99.4°
Vertical Cutoff Angle (3%): 99.3°

Conditions

AC Supply: 120 V, 60 Hz
Power: 308.15 W
Current: 2.57 A
Power Factor: 0.99



This data sheet conforms to American National Standard E1.9 – 2007 (R2017). All data was measured and calculated by a Viso Systems LabSpion Goniometer at the Chauvet PD Optics Laboratory in Sunrise, FL on 10/11/2019 to LM-63-2002 Standards.

Overall Measurement

Angular Beam Distribution

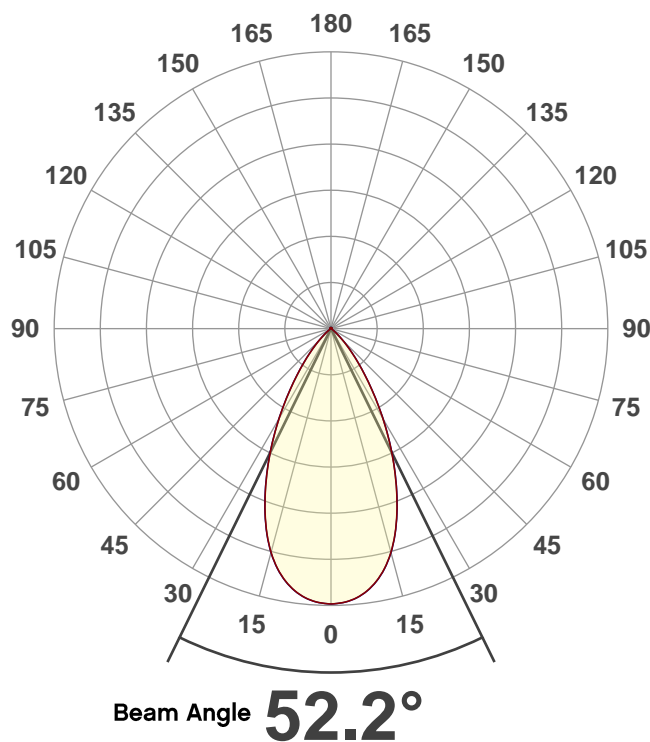

Spectral Distribution

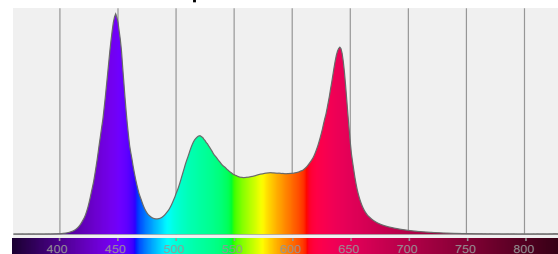

CIE 1931

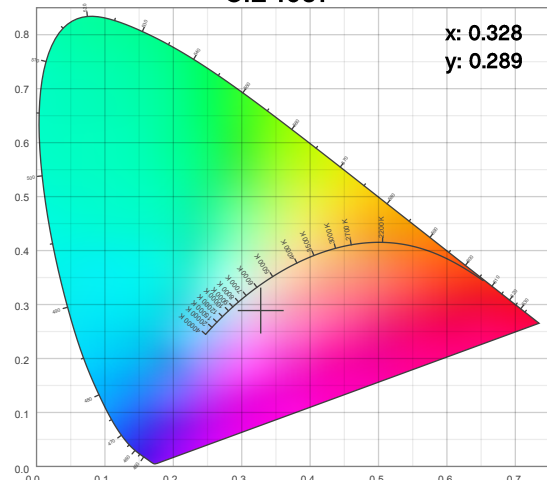

Photometric Report

Ovation F-915FC: Full Flood, Full Power

Beam Details

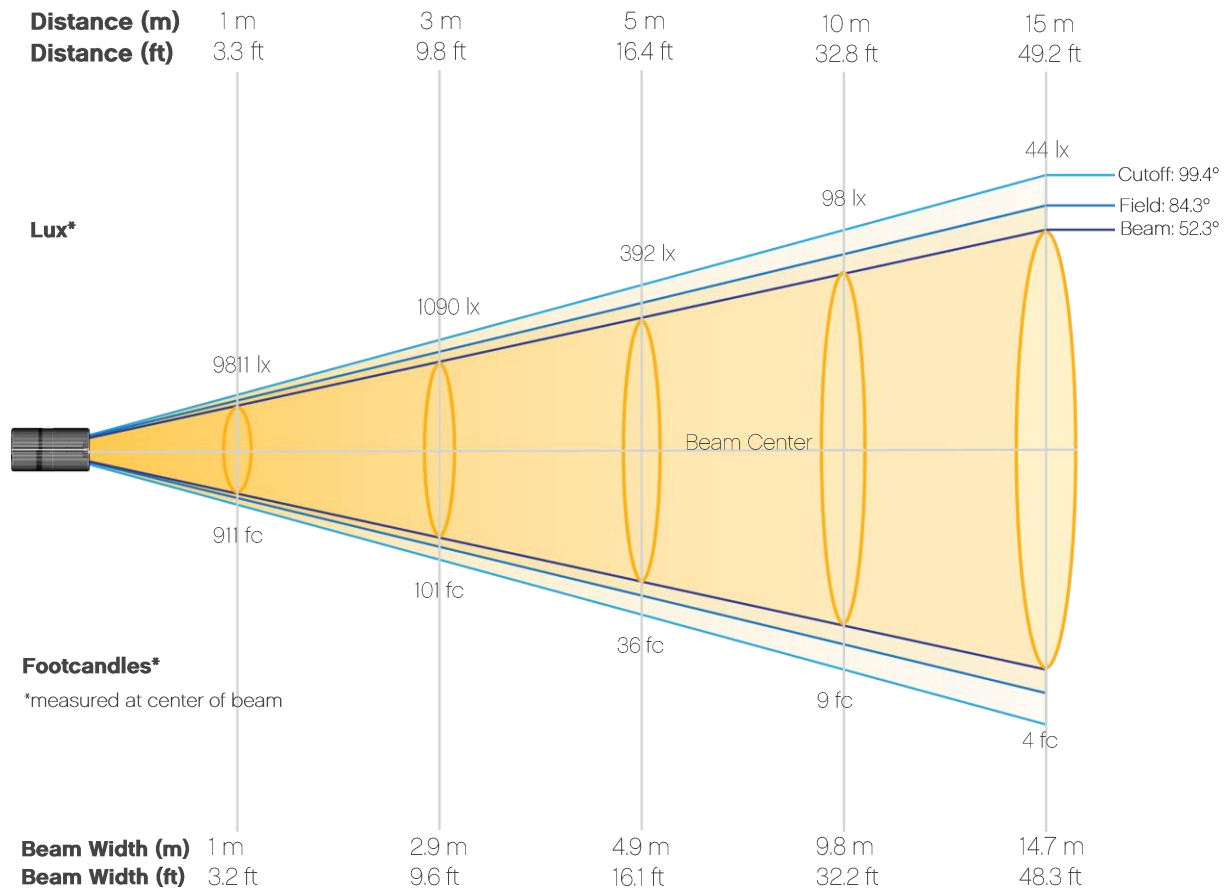

Beam luminances from 1-20m (3.3-65.6ft)

Distance	1m	2m	3m	4m	5m	6m	7m	8m	9m	10m
Lux	9811	2453	1090	613	392	273	200	153	121	98
Distance	11m	12m	13m	14m	15m	16m	17m	18m	19m	20m
Lux	81	68	58	50	44	38	34	30	27	25
Distance	3.3ft	6.6ft	9.8ft	13.1ft	16.4ft	19.7ft	23ft	26.2ft	29.5ft	32.8ft
FC	911	228	101	57	36	25	19	14	11	9
Distance	36.1ft	39.4ft	42.7ft	45.9ft	49.2ft	52.5ft	55.8ft	59.1ft	62.3ft	65.6ft
FC	8	6	5	5	4	4	3	3	3	2

Photometric Report

Ovation F-915FC: Full Flood, Full Power
Candela Plot

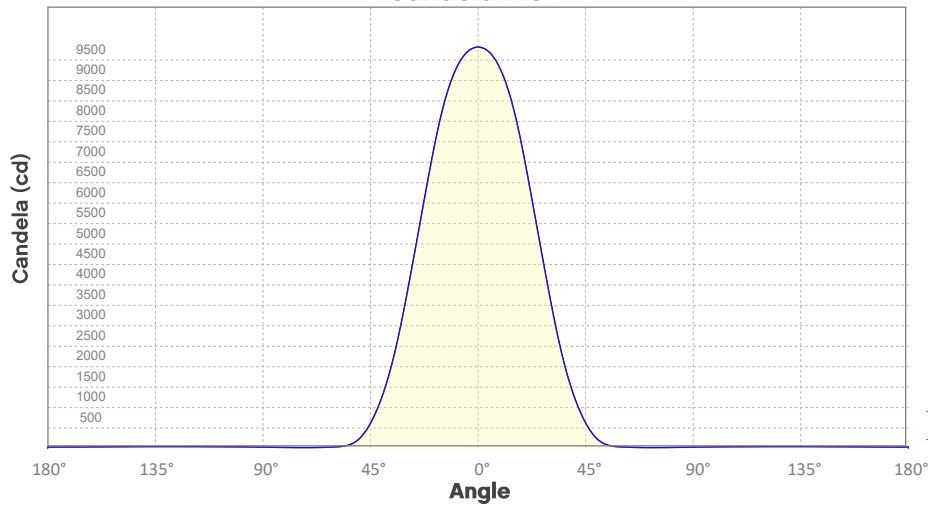

Beam Angle (50%): 52.2°
Field Angle (10%): 84.1°
Cutoff Angle (3%): 99.2°

— Horizontal Distribution
— Vertical Distribution

Polar Diagrams

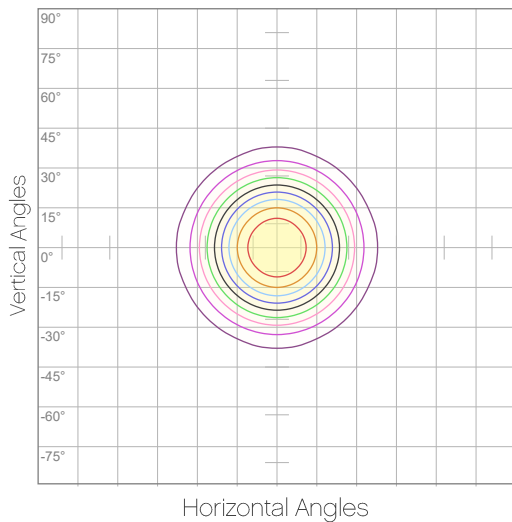

iso-candela Diagram

10%	981 cd
20%	1962 cd
30%	2943 cd
40%	3924 cd
50%	4905 cd
60%	5887 cd
70%	6868 cd
80%	7849 cd
90%	8830 cd

Conditions:
Number of c-planes: 8
Candela at center: 9811 cd

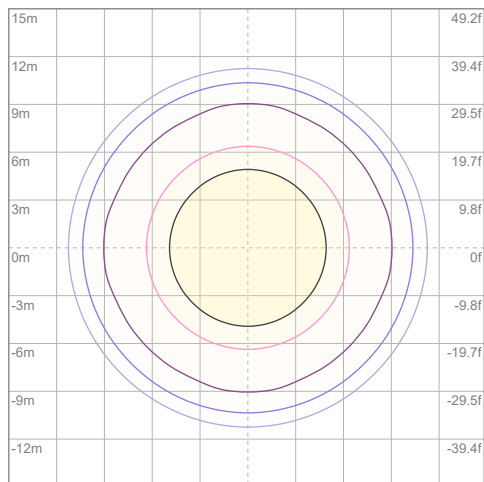

iso-illuminance Diagram

3%	2.94 lx
5%	4.91 lx
10%	9.81 lx
30%	29.4 lx
50%	49.1 lx

Conditions:
Number of c-planes: 8
Lux at center: 98.1 lx

Lux distribution on a surface when lamp is mounted at 10 meters from the surface.

Mounting height: 10 meters / 33 feet

Photometric Report

Ovation F-915FC: 50% Zoom, Full Power

Report Summary

Output

Total Lumens: 8175 lm
Peak Intensity: 26375 cd
Illuminance @ 5m: 1053 lux
Fixture Efficacy: 26 lm/W

Optical

Horizontal Beam Angle (50%): 30.9°
Vertical Beam Angle (50%): 31°
Horizontal Field Angle (10%): 51.6°
Vertical Field Angle (10%): 51.7°
Horizontal Cutoff Angle (3%): 60.1°
Vertical Cutoff Angle (3%): 60.1°

Conditions

AC Supply: 120 V, 60 Hz
Power: 310.74 W
Current: 2.60 A
Power Factor: 0.99



This data sheet conforms to American National Standard E1.9 – 2007 (R2017). All data was measured and calculated by a Viso Systems LabSpion Goniometer at the Chauvet PD Optics Laboratory in Sunrise, FL on 10/11/2019 to LM-63-2002 Standards.

Overall Measurement

Angular Beam Distribution

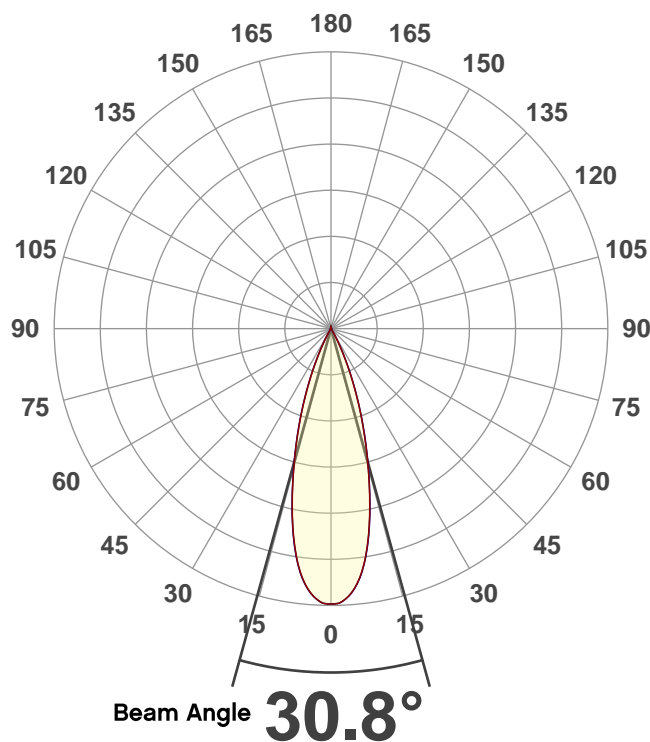

Spectral Distribution

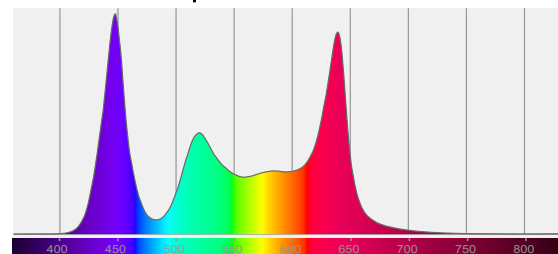

CIE 1931

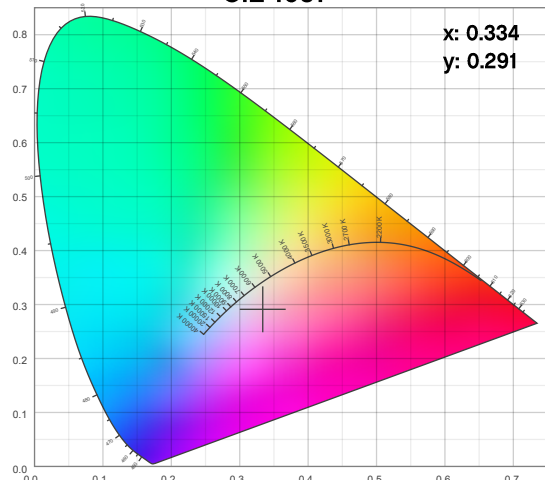

Photometric Report

Ovation F-915FC: 50% Zoom, Full Power

Beam Details

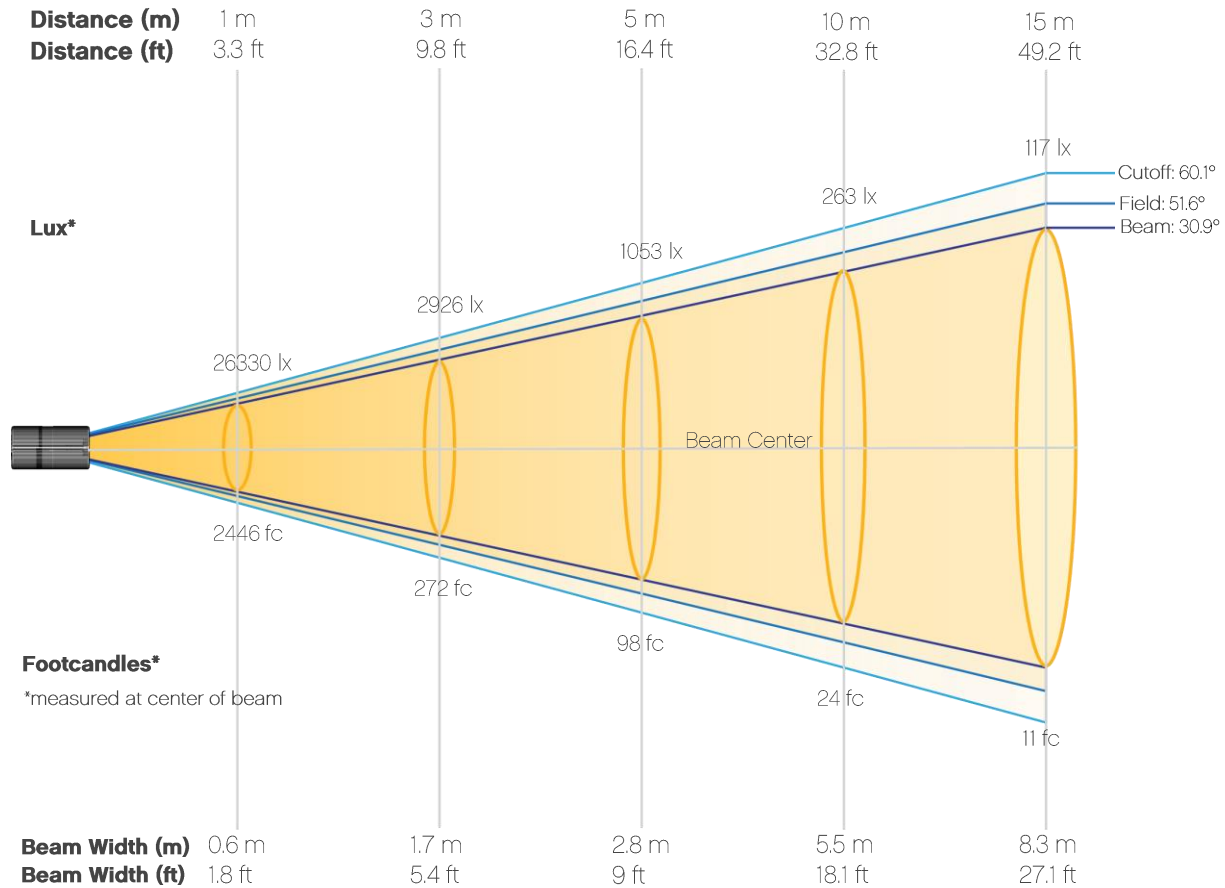

Beam Illuminances from 1-20m (3.3-65.6ft)

Distance	1m	2m	3m	4m	5m	6m	7m	8m	9m	10m
Lux	26330	6583	2926	1646	1053	731	537	411	325	263
Distance	11m	12m	13m	14m	15m	16m	17m	18m	19m	20m
Lux	218	183	156	134	117	103	91	81	73	66
Distance	3.3ft	6.6ft	9.8ft	13.1ft	16.4ft	19.7ft	23ft	26.2ft	29.5ft	32.8ft
FC	2446	612	272	153	98	68	50	38	30	24
Distance	36.1ft	39.4ft	42.7ft	45.9ft	49.2ft	52.5ft	55.8ft	59.1ft	62.3ft	65.6ft
FC	20	17	14	12	11	10	8	8	7	6

Photometric Report

Ovation F-915FC: 50% Zoom, Full Power

Candela Plot

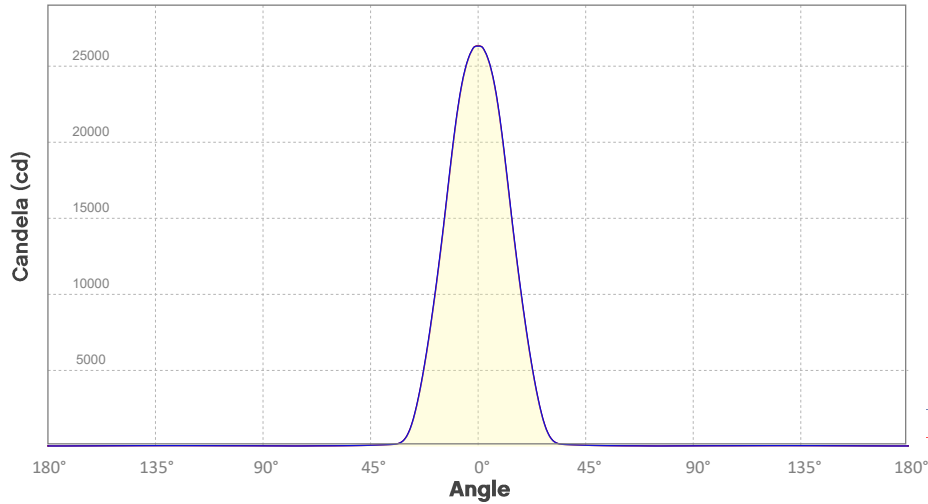

Beam Angle (50%): 30.8°
Field Angle (10%): 51.6°
Cutoff Angle (3%): 60.1°

— Horizontal Distribution
— Vertical Distribution

Polar Diagrams

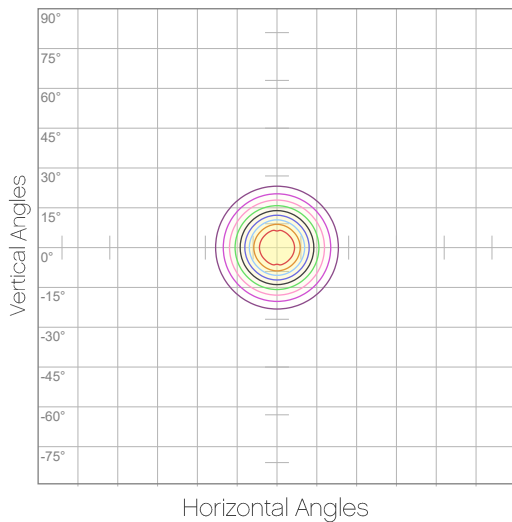

iso-candela Diagram

10%	2633 cd
20%	5266 cd
30%	7899 cd
40%	10532 cd
50%	13165 cd
60%	15798 cd
70%	18431 cd
80%	21064 cd
90%	23697 cd

Conditions:
Number of c-planes: 8
Candela at center: 26330 cd

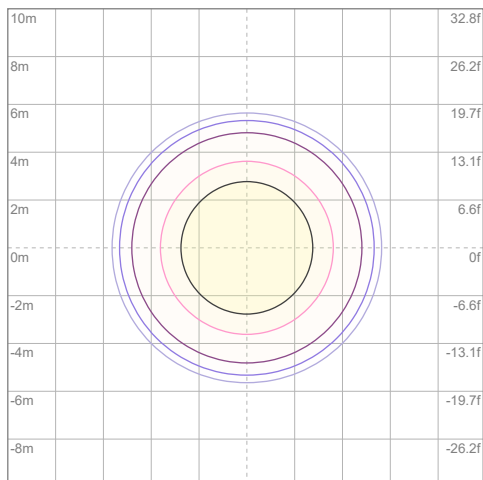

iso-illuminance Diagram

3%	7.90 lx
5%	13.2 lx
10%	26.3 lx
30%	79.0 lx
50%	132 lx

Conditions:
Number of c-planes: 8
Lux at center: 263 lx

Lux distribution on a surface when lamp is mounted at 10 meters from the surface.

Mounting height: 10 meters / 33 feet

Photometric Report

Ovation F-915FC: Full Spot, Full Power

Report Summary

Output

Total Lumens: 5266 lm
Peak Intensity: 42066 cd
Illuminance @ 5m: 1679 lux
Fixture Efficacy: 17 lm/W

Optical

Horizontal Beam Angle (50%): 18.3°
Vertical Beam Angle (50%): 18.2°
Horizontal Field Angle (10%): 32.6°
Vertical Field Angle (10%): 32.6°
Horizontal Cutoff Angle (3%): 39.2°
Vertical Cutoff Angle (3%): 39.4°

Conditions

AC Supply: 119 V, 60 Hz
Power: 318.22 W
Current: 2.66 A
Power Factor: 1.0



This data sheet conforms to American National Standard E1.9 – 2007 (R2017). All data was measured and calculated by a Viso Systems LabSpion Goniometer at the Chauvet PD Optics Laboratory in Sunrise, FL on 10/11/2019 to LM-63-2002 Standards.

Overall Measurement

Angular Beam Distribution

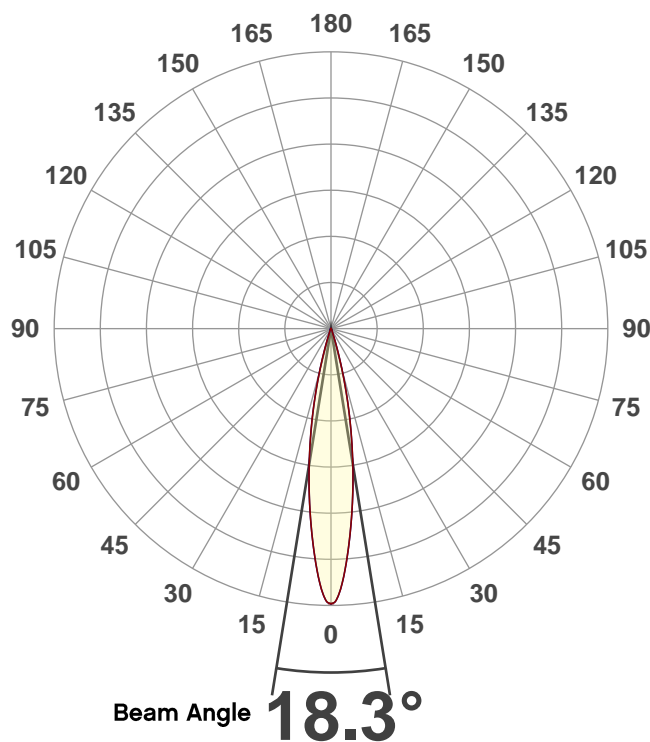

Spectral Distribution

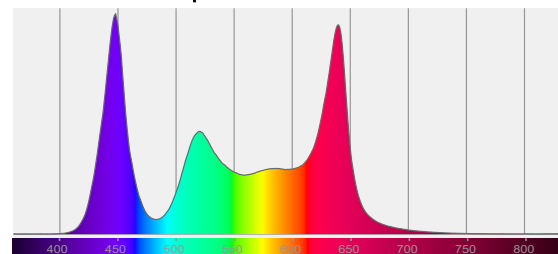

CIE 1931

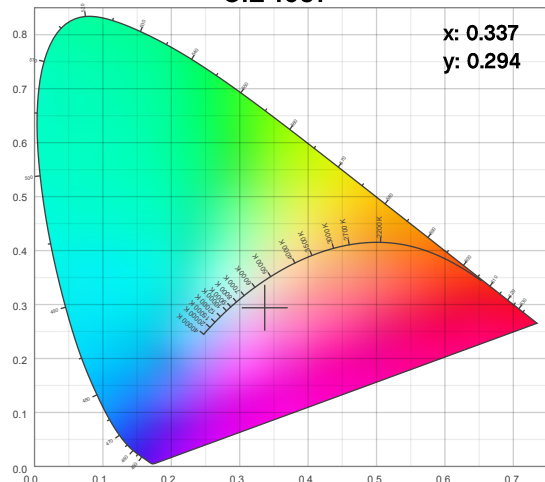

Photometric Report

Ovation F-915FC: Full Spot, Full Power

Beam Details

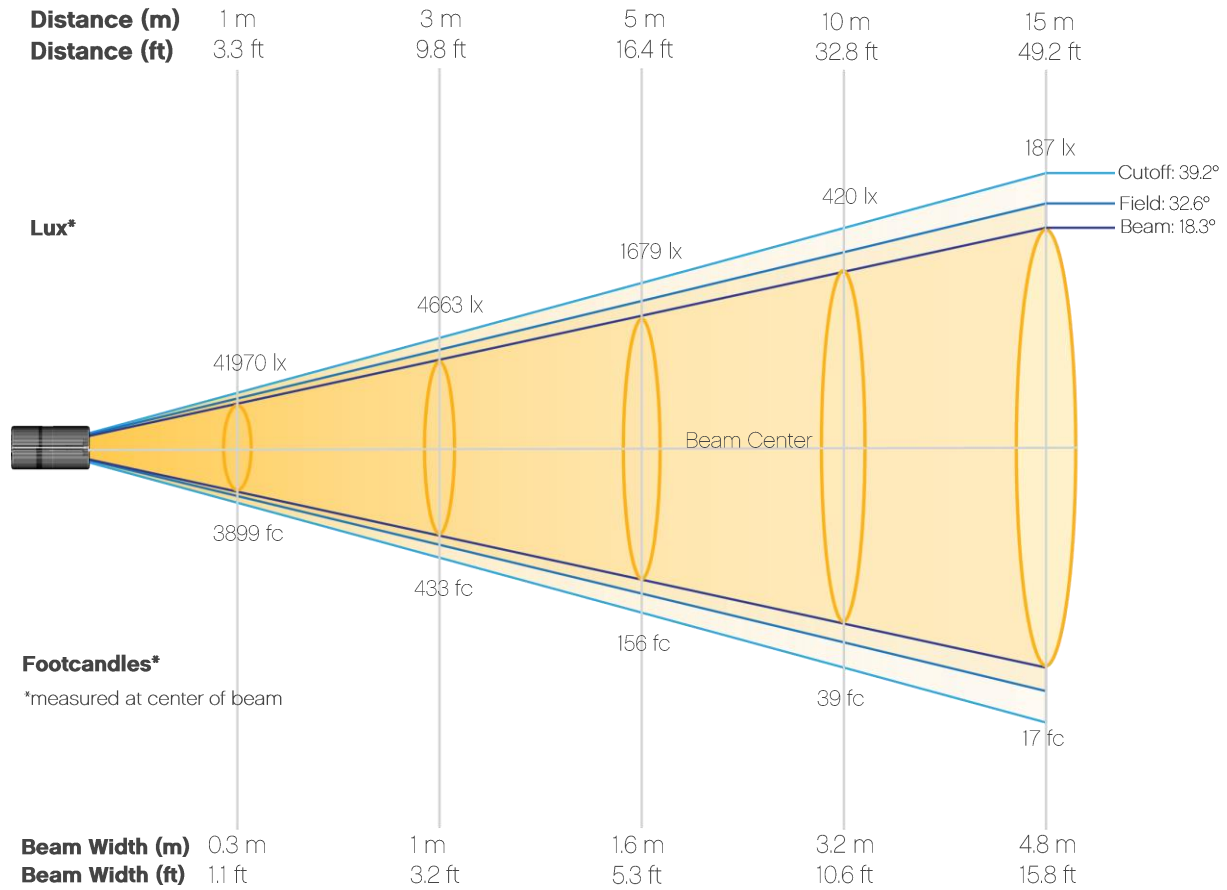

Beam Illuminances from 1-20m (3.3-65.6ft)

Distance	1m	2m	3m	4m	5m	6m	7m	8m	9m	10m
Lux	41970	10492	4663	2623	1679	1166	857	656	518	420
Distance	11m	12m	13m	14m	15m	16m	17m	18m	19m	20m
Lux	347	291	248	214	187	164	145	130	116	105
Distance	3.3ft	6.6ft	9.8ft	13.1ft	16.4ft	19.7ft	23ft	26.2ft	29.5ft	32.8ft
FC	3899	975	433	244	156	108	80	61	48	39
Distance	36.1ft	39.4ft	42.7ft	45.9ft	49.2ft	52.5ft	55.8ft	59.1ft	62.3ft	65.6ft
FC	32	27	23	20	17	15	13	12	11	10

Photometric Report

Ovation F-915FC: Full Spot, Full Power
Candela Plot

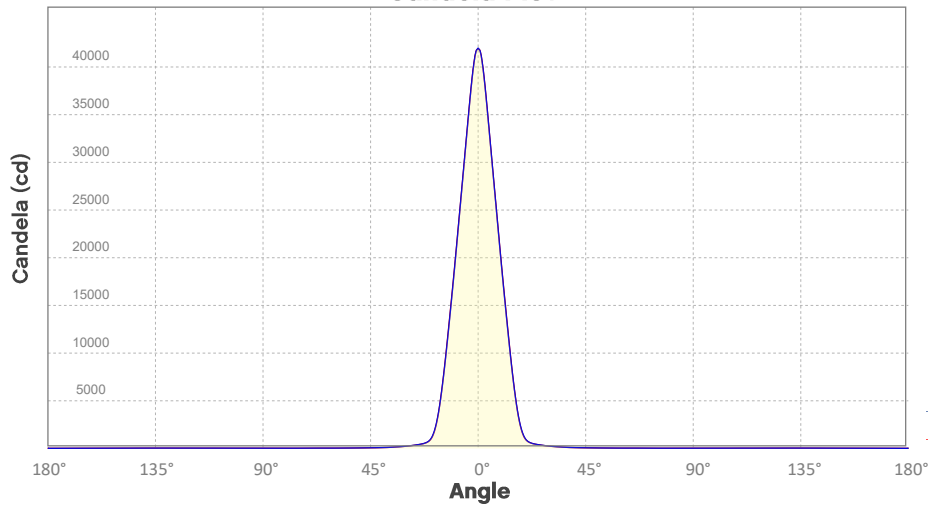

Beam Angle (50%): 18.3°
Field Angle (10%): 32.5°
Cutoff Angle (3%): 39.3°

— Horizontal Distribution
— Vertical Distribution

Polar Diagrams

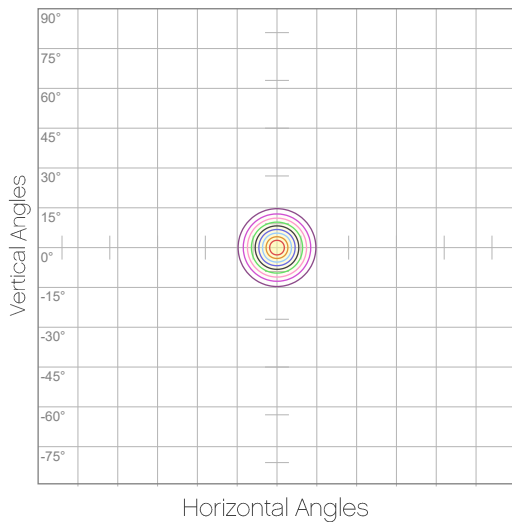

iso-candela Diagram

10%	4197 cd
20%	8394 cd
30%	12591 cd
40%	16788 cd
50%	20985 cd
60%	25182 cd
70%	29379 cd
80%	33576 cd
90%	37773 cd

Conditions:
Number of c-planes: 8
Candela at center: 41970 cd

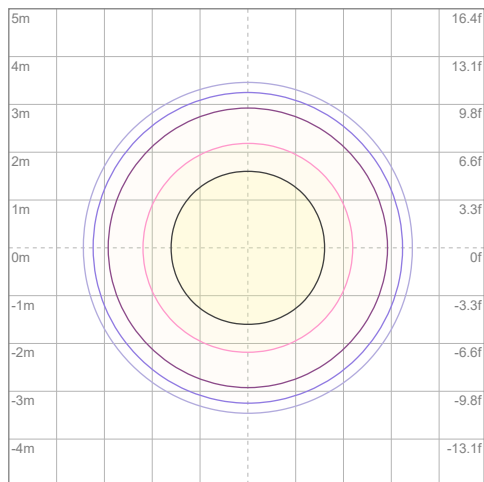

iso-illuminance Diagram

3%	12.6 lx
5%	21.0 lx
10%	42.0 lx
30%	126 lx
50%	210 lx

Conditions:
Number of c-planes: 8
Lux at center: 420 lx

Lux distribution on a surface when lamp is mounted at 10 meters from the surface.

Mounting height: 10 meters / 33 feet

Chromaticity Report

Ovation F-915FC: 3200K

Report Summary

Measurements

Total Lumens: 7422 lm
Peak Intensity: 25434 cd
Fixture Efficacy: 29 lm/W

Correlated Color Temperature: 3179K
 Δuv : -0.0008

CRI: 87.4 CRI R9 Value: 64.5
CQS: 88.7
TLCI: 68
TM-30-18 Rf: 86.9
TM-30-18 Rg: 111.4
1st Dominant Wavelength: 640 nm
2nd Dominant Wavelength: 520 nm



Spectral Distribution

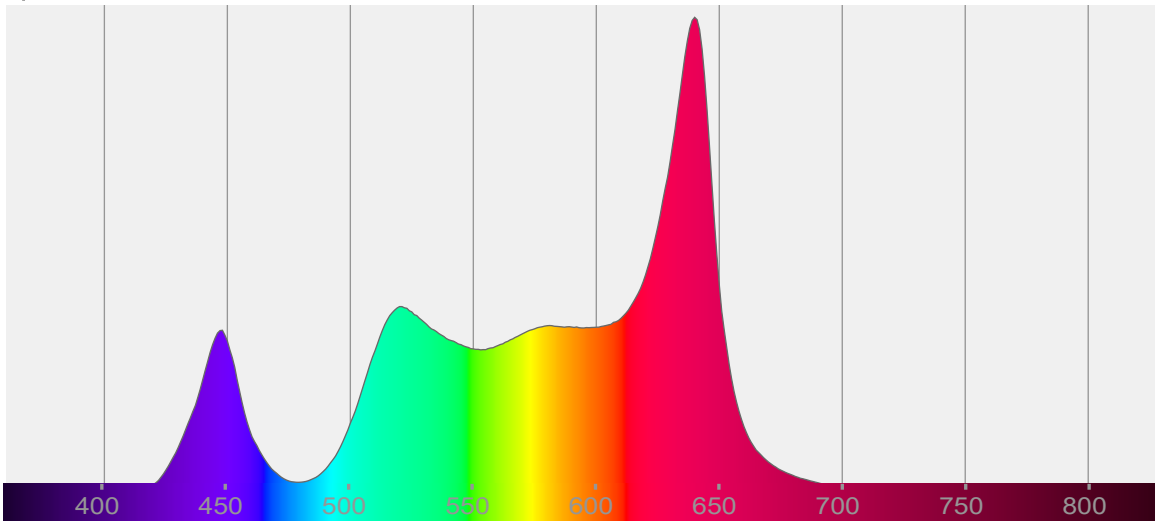

Tested Color

3179 K
CIE 1931 Coordinates:
X: 0.424 Y: 0.397

Color Temperature

3179 K

Light Quality

CRI: 87.4

Notes:

Chromaticity Report

Ovation F-915FC: 3200K

Chromaticity

CIE 1931

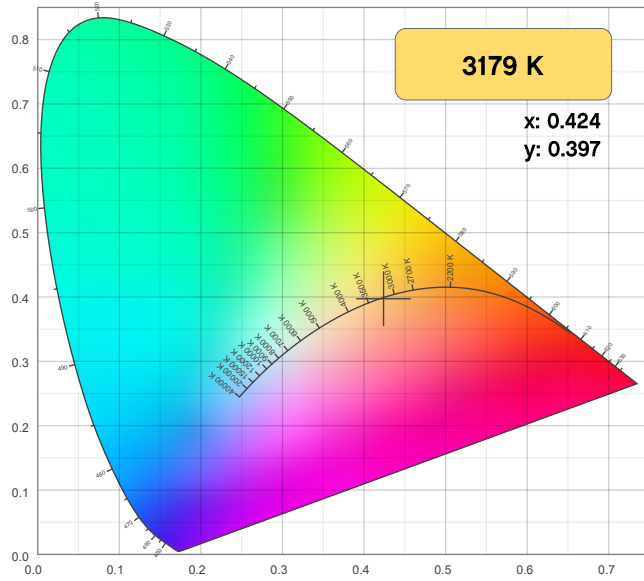

CIE 1931 - Zoom

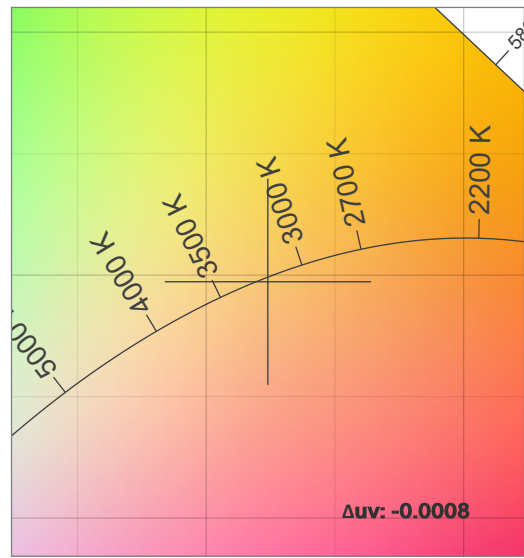

CRI: 87.4 (R1-R8)

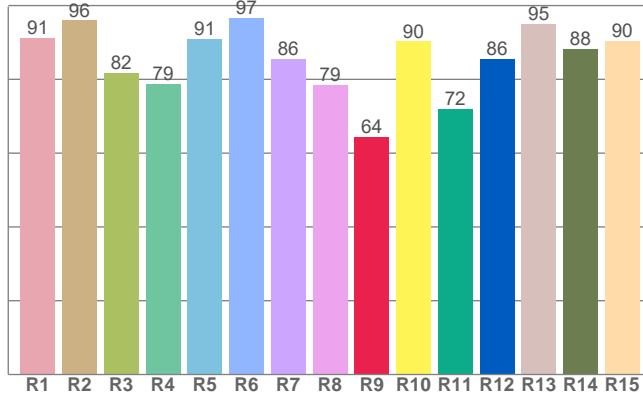

CQS: 88.7

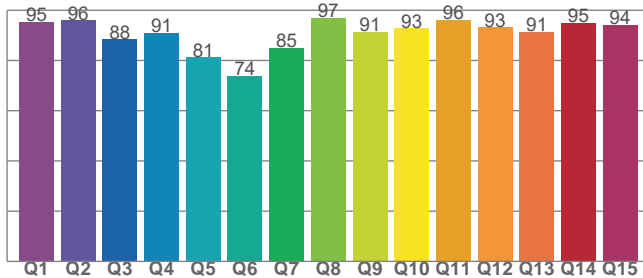

Color Parameters

Color Temperature	Color Coordinate CIE 1931	Color Coordinate CIE 1931
CCT	x	y
3179 K	0.424	0.397

Color Deviation from Black Body Curve	Color Coordinate CIE 1964	Color Coordinate CIE 1964
Δ_{uv}	y	u
-0.0008	0.397	0.245

Color Rendering Index	Red Component	Color Quality Scale
CRI	CRI - R9	CQS
87.4	64.5	88.7

Television Lighting Consistency Index	Color Fidelity	Color Gamut
TLCI	TM-30-18 - Rf	TM-30-18 Rg
68	86.9	111.4

Chromaticity Report

Ovation F-915FC: 3200K

TM-30-18 Details

Rf 86.9

Fidelity Index
(R_f)

Rg 111.4

Gamut Index (R_g)

Hue Bin	R _f	Chroma Shift	Hue Shift
1	88	4%	-4%
2	92	2%	-2%
3	91	2%	3%
4	88	5%	6%
5	85	10%	7%
6	79	14%	4%
7	77	13%	-6%
8	79	10%	-9%
9	85	2%	-10%
10	87	-4%	-7%
11	90	-3%	4%
12	89	3%	4%
13	90	6%	3%
14	89	8%	5%
15	87	8%	-1%
16	87	9%	-6%

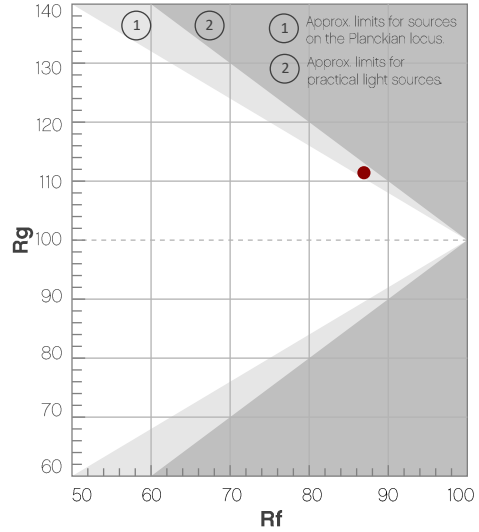

Color Vector Graphic

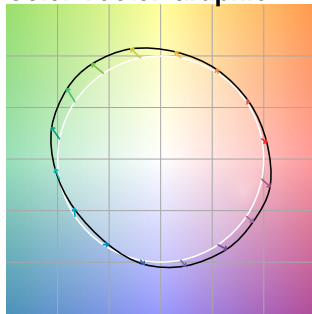

Color Distortion Graphic



R_f by Hue Bin

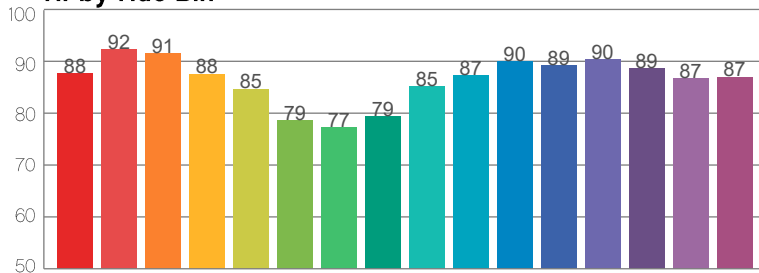

Local Chroma Shift by Hue Bin

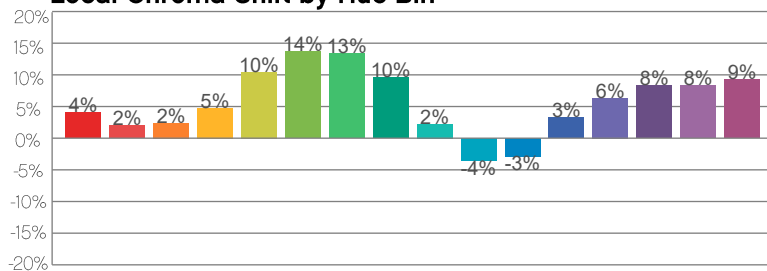

Color Sample Fidelity

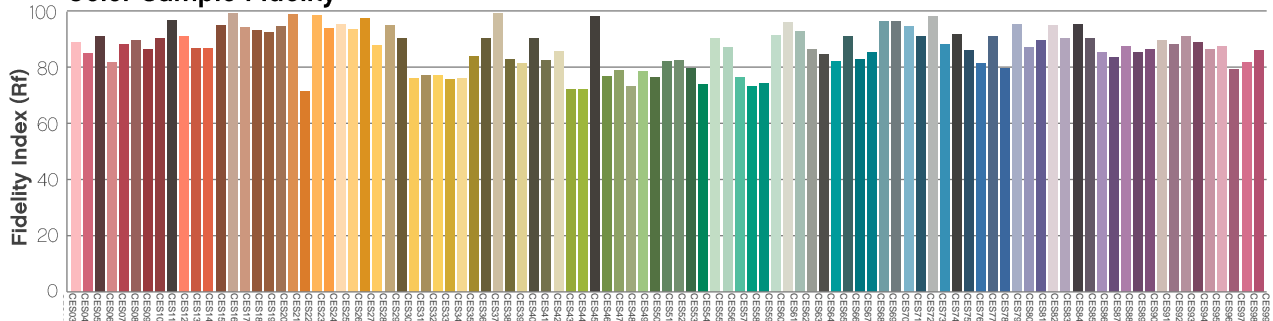

Chromaticity Report

Ovation F-915FC: 5600K

Report Summary

Measurements

Total Lumens: 8283 lm
Peak Intensity: 27840 cd
Fixture Efficacy: 28 lm/W

Correlated Color Temperature: 5586K
 Δuv : -0.0049

CRI: 85.7 CRI R9 Value: 75.4
CQS: 89.3
TLCI: 76
TM-30-18 Rf: 84.9
TM-30-18 Rg: 110.6
1st Dominant Wavelength: 448 nm
2nd Dominant Wavelength: 640 nm



Spectral Distribution

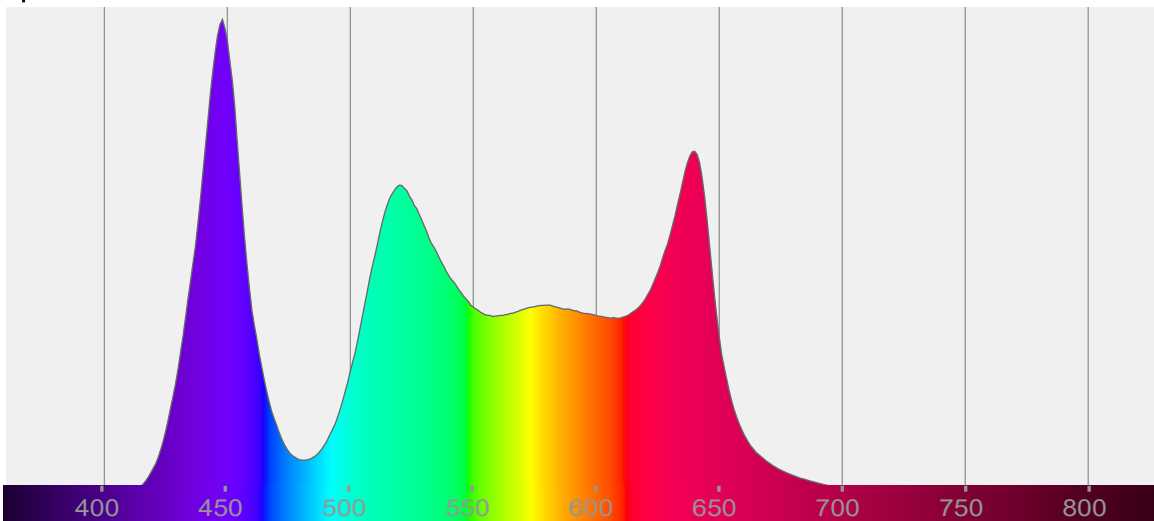

Tested Color

5586 K

CIE 1931 Coordinates:
X: 0.331 Y: 0.336

Color Temperature

5586 K

Light Quality

CRI: 85.7

Notes:

Chromaticity Report

Ovation F-915FC: 5600K

Chromaticity

CIE 1931

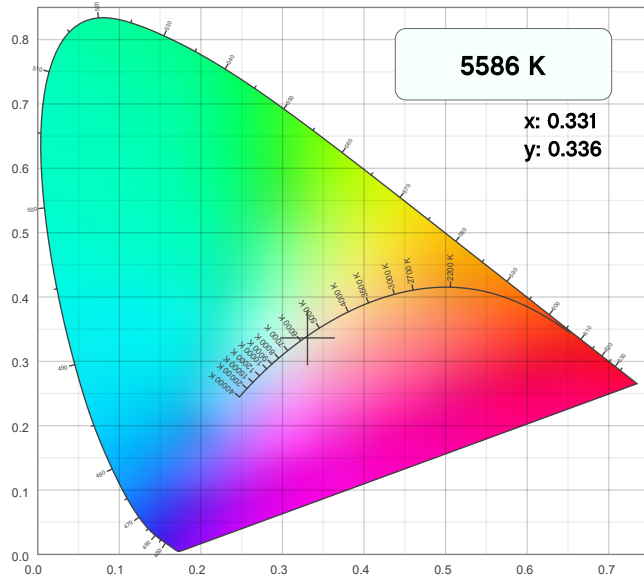

CIE 1931 - Zoom

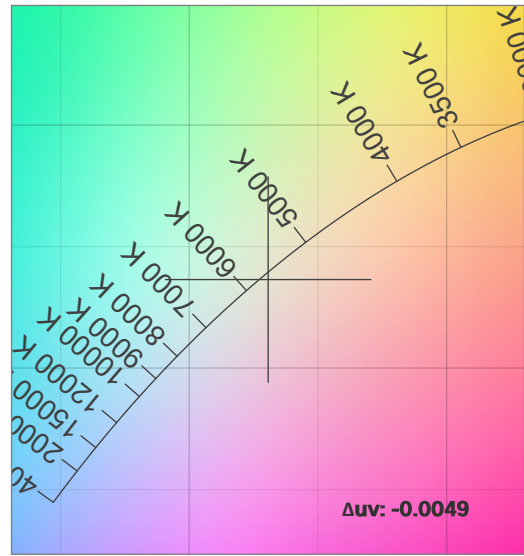

CRI: 85.7 (R1-R8)

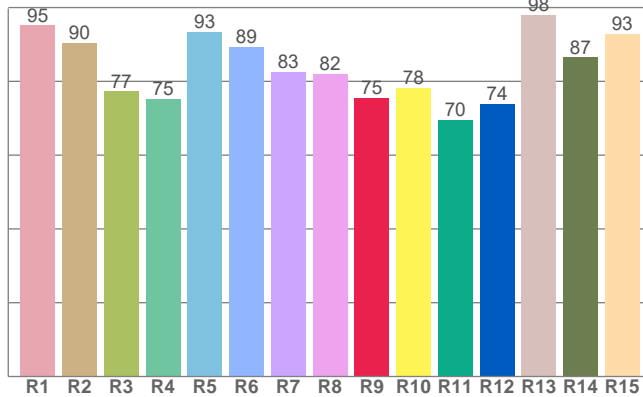

CQS: 89.3

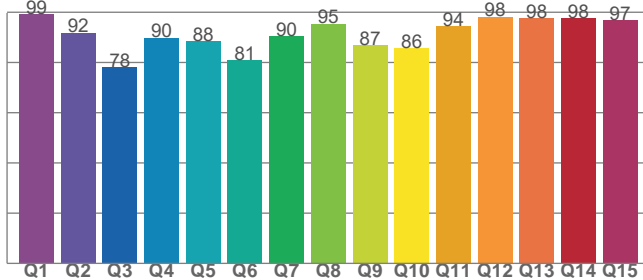

Color Parameters

Color Temperature	Color Coordinate CIE 1931	Color Coordinate CIE 1931
CCT	x	y
5586 K	0.331	0.336

Color Deviation from Black Body Curve	Color Coordinate CIE 1964	Color Coordinate CIE 1964
Δuv	y	u
-0.0049	0.336	0.207

Color Rendering Index	Red Component	Color Quality Scale
CRI	CRI - R9	CQS
85.7	75.4	89.3

Television Lighting Consistency Index	Color Fidelity	Color Gamut
TLCI	TM-30-18 - Rf	TM-30-18 Rg
76	84.9	110.6

Chromaticity Report

Ovation F-915FC: 5600K

TM-30-18 Details

Rf 84.9
Fidelity Index (R_f)

Rg 110.6
Gamut Index (R_g)

Hue Bin	R _f	Chroma Shift	Hue Shift
1	90	3%	-3%
2	95	0%	0%
3	88	2%	6%
4	84	4%	9%
5	81	9%	9%
6	79	14%	5%
7	82	12%	-3%
8	86	5%	-7%
9	91	-2%	-6%
10	91	-5%	1%
11	77	-2%	14%
12	80	2%	14%
13	84	8%	12%
14	80	10%	7%
15	83	16%	0%
16	86	8%	-4%

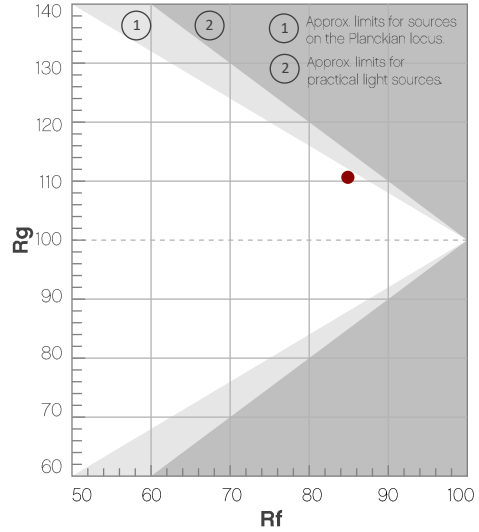

Color Vector Graphic

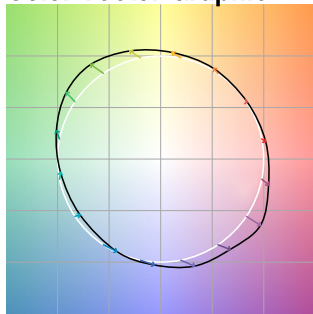

Color Distortion Graphic



R_f by Hue Bin

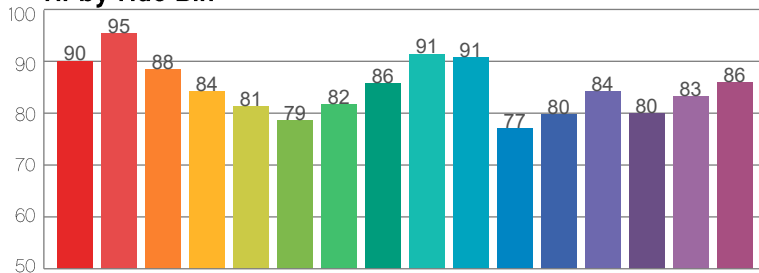

Local Chroma Shift by Hue Bin

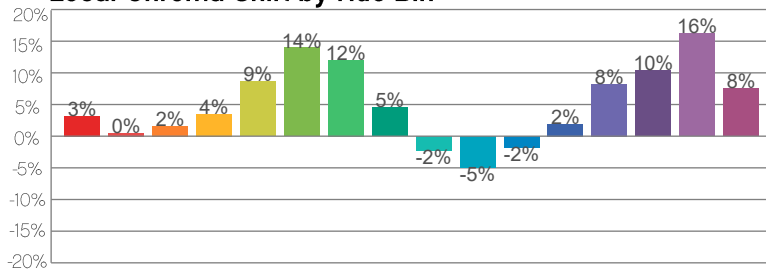

Color Sample Fidelity

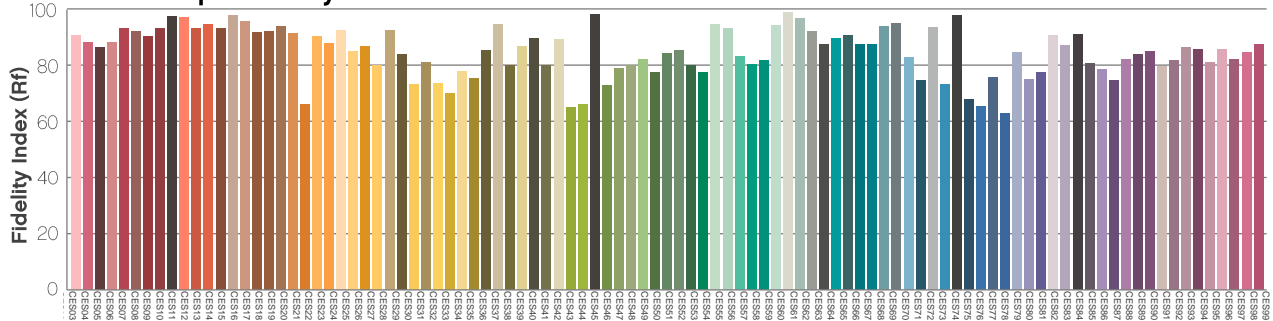

Contact Us

General Information	Technical Support
Chauvet World Headquarters	
5200 NW 108 th Ave. Sunrise, FL 33351 Voice: (954) 577-4455 Fax: (954) 929-5560 Toll Free: (800) 762-1084	Voice: (844) 393-7575 Fax: (954) 756-8015 Email: chauvetcs@chauvetlighting.com Website: www.chauvetprofessional.com
Chauvet Europe Ltd	
Unit 1C Brookhill Road Industrial Estate Pinxton, Nottingham, UK NG16 6NT Voice: +44 (0) 1773 511115 Fax: +44 (0) 1773 511110	Email: UKtech@chauvetlighting.eu Website: www.chauvetprofessional.eu
Chauvet Europe BVBA	
Stokstraat 18 9770 Kruishoutem, Belgium Voice: +32 (9) 388 93 97	Email: BNLtech@chauvetlighting.eu Website: www.chauvetprofessional.eu
Chauvet France	
3, Rue Ampère 91380 Chilly-Mazarin, France Voice: +33 1 78 85 33 59	Email: FRtech@chauvetlighting.fr Website: www.chauvetprofessional.eu
Chauvet Germany	
Bruno-Bürgel-Str. 11 28759 Bremen, Germany Voice: +49 421 62 60 20	Email: DEtech@chauvetlighting.de Website: www.chauvetprofessional.eu
Chauvet Mexico	
Av. de las Partidas 34 - 3B (Entrance by Calle 2) Zona Industrial Lerma Lerma, Edo. de México, CP 52000 Voice: +52 (728) 690-2010	Email: servicio@chauvetlighting.de Website: www.chauvetprofessional.eu

Visit the applicable website above to verify our contact information and instructions to request support. Outside the U.S., U.K., Ireland, Benelux, France, Germany, or Mexico, contact the dealer of the record.

