

EZLink Par Q4BT

User Manual

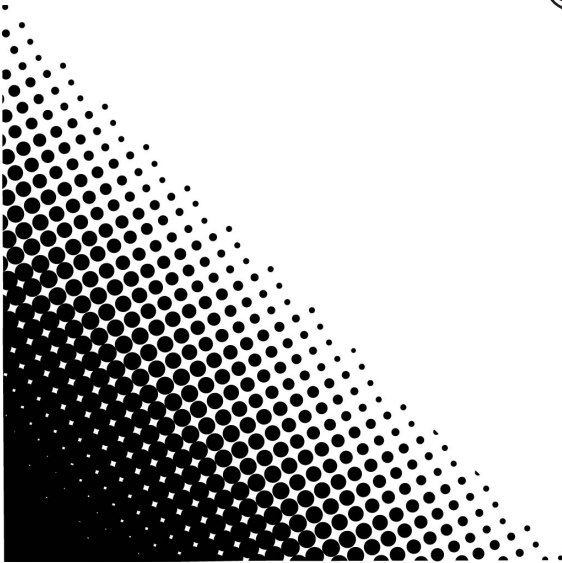
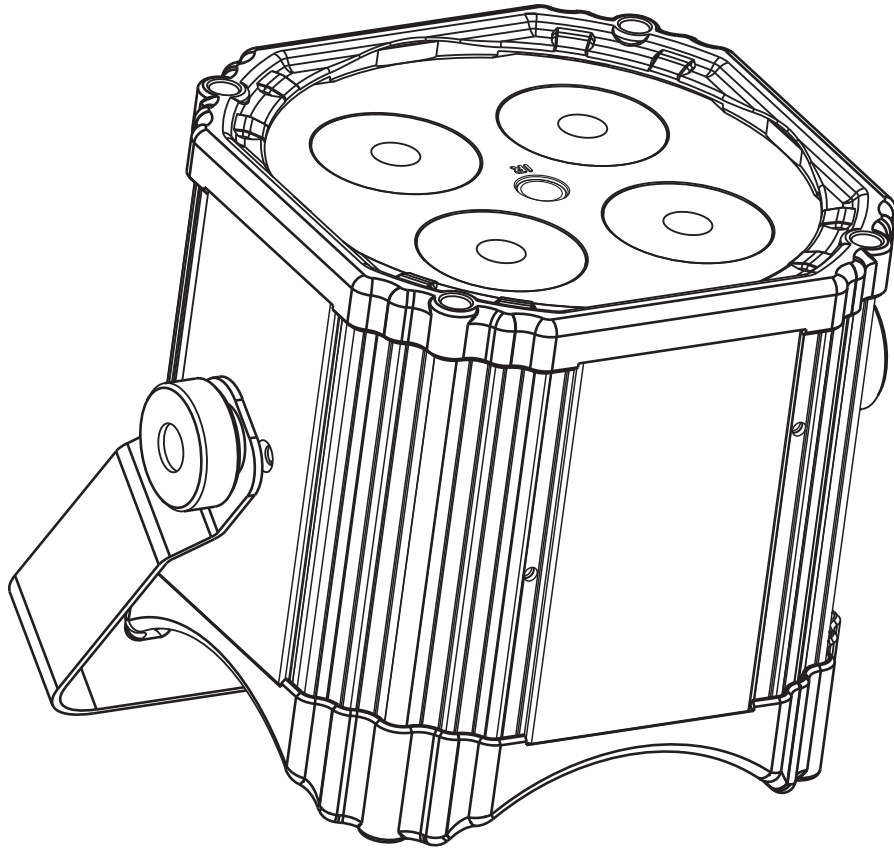

TABLE OF CONTENTS

| | |
|--|----|
| 1. Before You Begin | 1 |
| What Is Included | 1 |
| Unpacking Instructions..... | 1 |
| Claims | 1 |
| Text Conventions | 1 |
| Symbols | 1 |
| Disclaimer | 1 |
| Intellectual Property | 1 |
| Safety Notes..... | 2 |
| 2. Introduction | 3 |
| Product Overview..... | 3 |
| Product Dimensions..... | 4 |
| 3. Setup | 5 |
| AC Power | 5 |
| Fuse Replacement..... | 5 |
| Power Linking..... | 5 |
| Power-Linking Diagram | 5 |
| Battery Power..... | 6 |
| Charging the Battery | 6 |
| Battery Life Indicator | 6 |
| Battery Run Time | 6 |
| 4. Operation | 7 |
| Control Panel Operation..... | 7 |
| Menu Map | 7 |
| Configuration (DMX) | 7 |
| Starting Address..... | 7 |
| DMX Personalities..... | 8 |
| DMX Channel Assignments and Values | 8 |
| 8Ch..... | 8 |
| 4Ch..... | 8 |
| Configuration (Bluetooth) | 9 |
| Configuration (Standalone) | 9 |
| Automatic Programs..... | 9 |
| Auto-Program Speed..... | 9 |
| Sound-Active Mode | 9 |
| Preset Color Mode | 9 |
| Custom Color Mixing..... | 9 |
| IRC-6 Infrared Remote Control | 10 |
| IRC-6 Operation | 10 |
| Master/Slave Mode | 11 |
| 5. Maintenance | 12 |
| Product Maintenance | 12 |
| 6. Technical Specifications | 13 |
| Returns | 14 |
| Contact Us | 15 |

1. Before You Begin

What Is Included

- EZLink Par Q4BT
- Power cord
- Quick Reference Guide

Unpacking Instructions

Carefully unpack the product immediately and check the container to make sure all the parts are in the package and are in good condition.

Claims





If the box or the contents (the product and included accessories) appear damaged from shipping, or show signs of mishandling, notify the carrier immediately, not Chauvet. Failure to report damage to the carrier immediately may invalidate your claim. In addition, keep the box and contents for inspection.

For other issues, such as missing components or parts, damage not related to shipping, or concealed damage, file a claim with Chauvet within 7 days of delivery.

Text Conventions

| Convention | Meaning |
|----------------------|--|
| 1–512 | A range of values |
| 50/60 | A set of values of which only one can be chosen |
| Settings | A menu option not to be modified |
| <ENTER> | A key to be pressed on the product's control panel |
| ON | A value to be entered or selected |

Symbols

| Symbol | Meaning |
|---|---|
|  | Electrical warning. Not following these instructions may cause electrical damage to the product, accessories, or the user. |
|  | Critical installation, configuration, or operation information. Not following these instructions may make the product not work, cause damage to the product, or cause harm to the operator. |
|  | Important installation or configuration information. The product may not function correctly if this information is not used. |
|  | Useful information. |

Disclaimer

Chauvet believes that the information contained in this manual is accurate in all respects. However, Chauvet assumes no responsibility and specifically disclaims any and all liability to any party for any loss, damage or disruption caused by any errors or omissions in this document, whether such errors or omissions result from negligence, accident or any other cause. Chauvet reserves the right to revise the content of this document without any obligation to notify any person or company of such revision, however, Chauvet has no obligation to make, and does not commit to make, any such revisions. Download the latest version from www.chauvetdj.com.

Intellectual Property

The works of authorship contained in this manual, including, but not limited to, all design, text and images are owned by Chauvet.

© Copyright 2020 Chauvet & Sons, LLC. All rights reserved.

Electronically published by Chauvet in the United States of America.

CHAUVET, the Chauvet logo, and EZLink Par Q4BT are registered trademarks or trademarks of Chauvet & Sons LLC (d/b/a Chauvet and Chauvet Lighting) in the United States and other countries. Other company and product names and logos referred to herein may be trademarks of their respective companies.

Safety Notes



- This product is not intended for permanent installation.
- Always connect the product to a grounded circuit to avoid the risk of electrocution.
- Always disconnect the product from the power source before cleaning or replacing the fuse.
- Avoid direct eye exposure to the light source while the product is on.
- Make sure the power cord is not crimped or damaged.
- Never disconnect the product from power by pulling or tugging on the cord.
- Make sure there are no flammable materials close to the product when operating.
- Do not touch the product's housing when operating because it may be very hot.



- The voltage of the outlet to which you are connecting this product must be within the range stated on the decal or rear panel of the product.
- The product is for indoor use only! (IP20) To prevent risk of fire or shock, do not expose the product to rain or moisture.
- This product is intended for floor mounting only. Do not hang overhead.
- Always place the product in a location with adequate ventilation, at least 20 in (50 cm) from adjacent surfaces.
- Be sure that no ventilation slots on the product's housing are blocked.
- Never connect the product to a dimmer or rheostat.
- Make sure to replace the fuse with another of the same type and rating.
- Never carry the product from the power cord or any moving part.
- The maximum ambient temperature is 104 °F (40 °C). Do not operate this product at higher temperatures.
- In the event of a serious operating problem, stop using the product immediately.
- Do not open this product. It contains no user-serviceable parts.
- To eliminate unnecessary wear and improve its lifespan, during periods of non-use completely disconnect the product from power via breaker or by unplugging it.



Keep this User Manual for future use. If the product is sold to someone else, be sure that they also receive this document.

2. Introduction

Product Overview

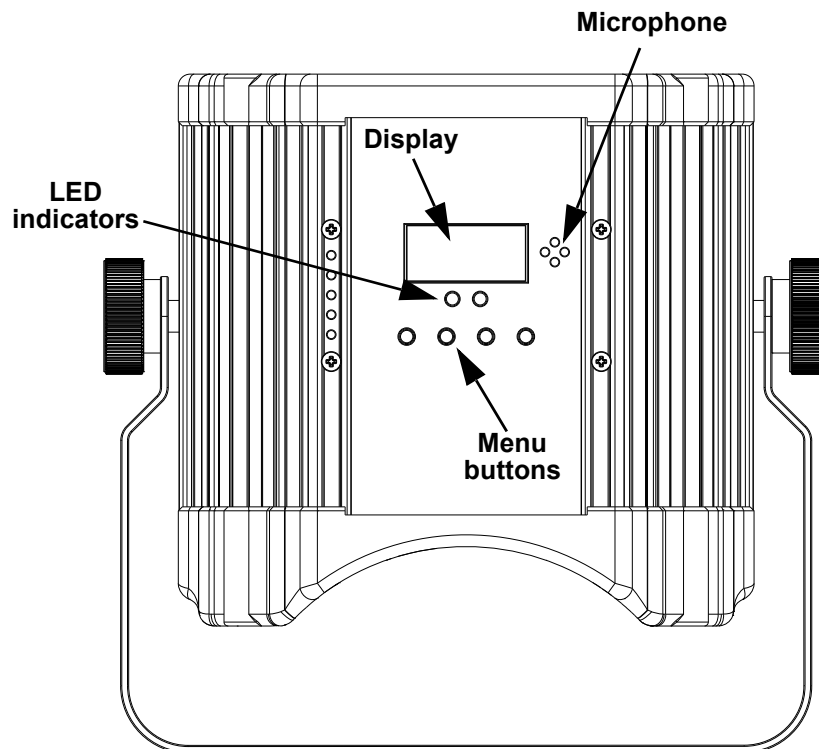
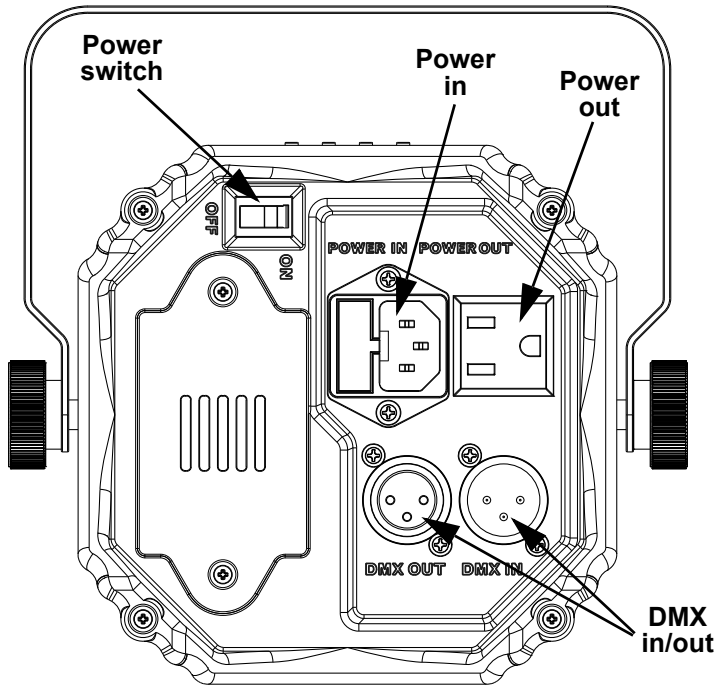

Product Dimensions

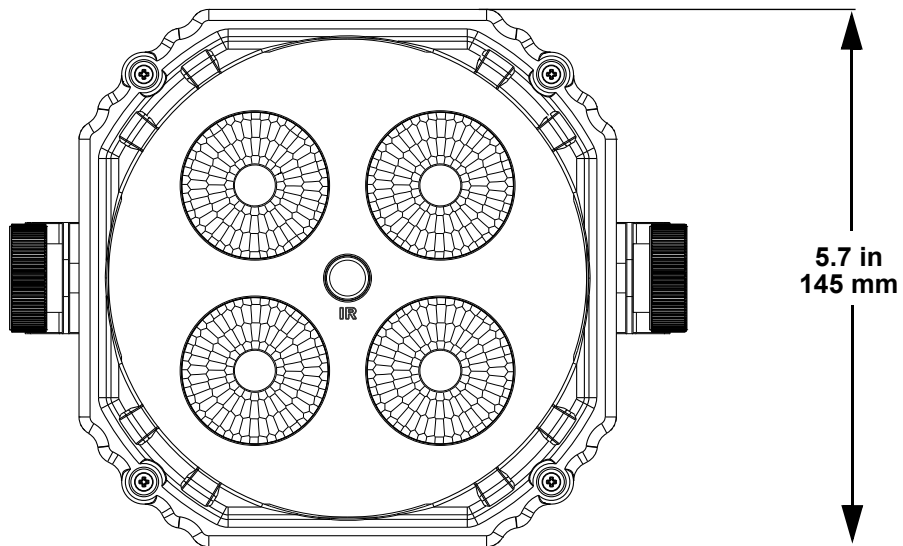
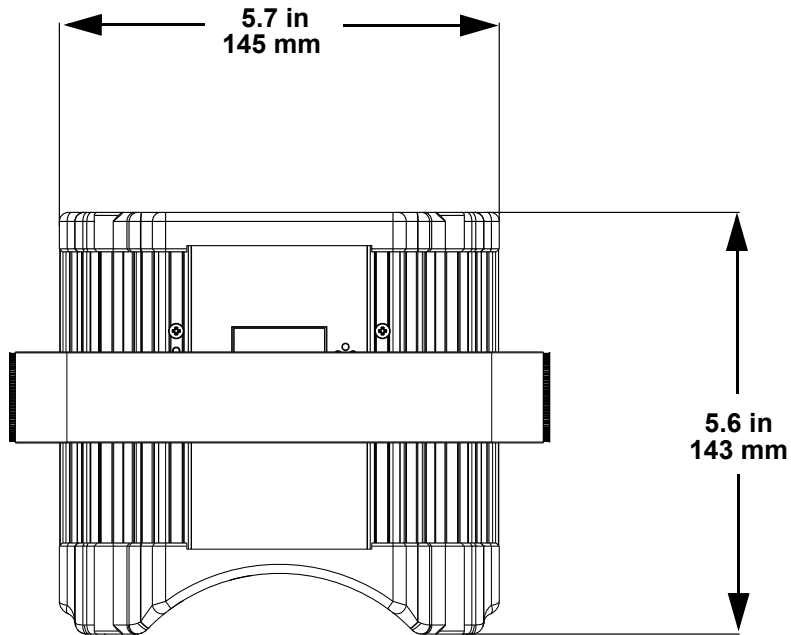

3. Setup

AC Power

The EZLink Par Q4BT has an auto-ranging power supply and it can work with an input voltage range of 100 to 240 VAC, 50/60 Hz.

To determine the product's power requirements (circuit breaker, power outlet, and wiring), use the current value listed on the label affixed to the product's back panel, or refer to the product's specifications chart. The listed current rating indicates the product's average current draw under normal conditions.



- **Always connect the product to a protected circuit (a circuit breaker or fuse). Make sure the product has an appropriate electrical ground to avoid the risk of electrocution or fire.**
- **To eliminate unnecessary wear and improve its lifespan, during periods of non-use completely disconnect the product from power via breaker or by unplugging it.**



Never connect the product to a rheostat (variable resistor) or dimmer circuit, even if the rheostat or dimmer channel serves only as a 0 to 100% switch.

Fuse Replacement

1. Disconnect the product from power.
2. Wedge the tip of a flat-head screwdriver into the slot of the fuse holder.
3. Pry the fuse holder out of the housing.
4. Remove the blown fuse from the holder and replace with a fuse of the exact same type and rating.
5. Insert the fuse holder back in place and reconnect power.

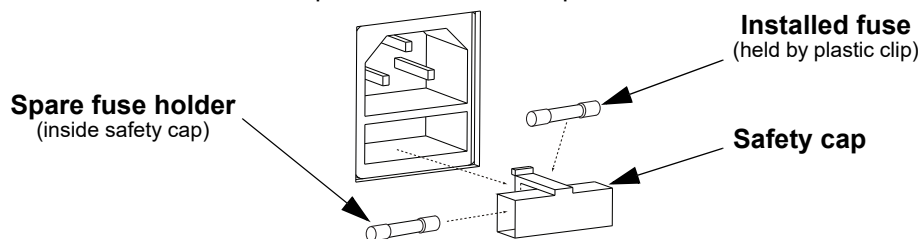

Disconnect the product from the power outlet before replacing the fuse.

Power Linking

The product provides power linking via the outlets located in the back of the product. See the diagram below for further explanation.

Power-Linking Diagram

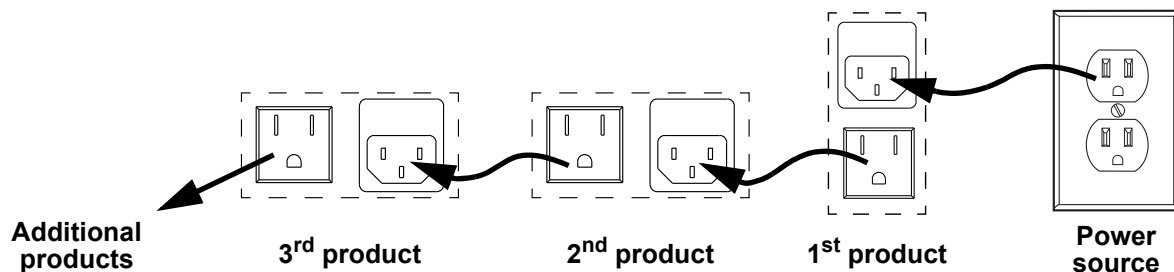

You can power link up to 27 EZLink Par Q4BT products on 120 VAC or up to 50 EZLink Par Q4BT products on 230 VAC.



The power linking diagram shown above corresponds to the North American version of the product ONLY! If using the product in other markets, you must consult with the local Chauvet distributor as power linking connectors and requirements may differ in your country or region.

Battery Power

The EZLink Par Q4BT comes with a rechargeable lithium battery for cable free operation.

Charging the Battery

The battery charges whenever the EZLink Par Q4BT is plugged into a power source using the included power cord. If the product is plugged in and not in operation, make sure the product is turned off.



- The LED indicator light will flash if you overpower your units.
- DO NOT use the EZLink Par Q4BT on full power mode (all LEDs at 100%) while it is being charged/plugged into a power source, as the unit will get extremely hot.

Battery Life Indicator

The indicators on the LED Menu Display show how much battery life remains available. The drawing below provides a key to reading the battery life indicators.

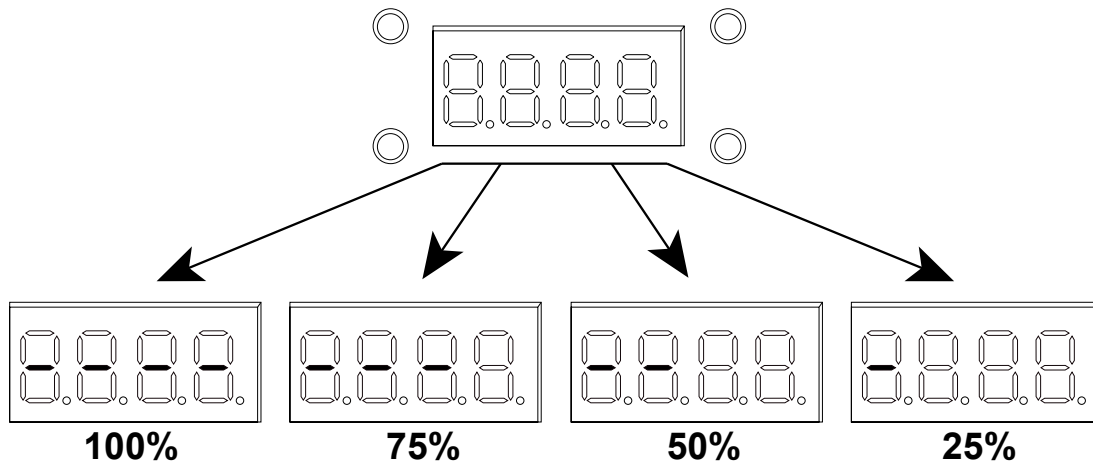

Battery Run Time

| Maximum Run Time (all colors on) | Recharge Time |
|----------------------------------|---------------|
| Up to 8 hours | 7.5 hours |

4. Operation

Control Panel Operation

To access the control panel functions, use the four buttons located underneath the display. Please refer to the [Product Overview](#) to see the button locations on the control panel.

| Button | Function |
|---------|---|
| <MENU> | Press to find an operation mode or to back out of the current menu option |
| <UP> | Press to scroll up the list of options or to increase the numeric value in a function |
| <DOWN> | Press to scroll down the list of options or to decrease the numeric value in a function |
| <ENTER> | Press to activate a menu option or set the selected value in a function |

Menu Map

| Mode | Programming Levels | | Description | |
|---------------------|--------------------|----------|--|---|
| DMX Mode | 4Ch | d 1–509 | 4-channel DMX mode | |
| | 8Ch | | 8-channel DMX mode | |
| Static Colors | C-- | C 1–15 | Static colors | |
| Automatic Programs | P-- | P 1–5 | Automatic programs | |
| Auto Speed | S-- | S. 1–100 | Program speed for P1–5, slow to fast | |
| Dimmer | d-- | L. 1–255 | Dimmer for the Auto/Sound programs | |
| Sound-Active Mode | Snd | Snd1–5 | Sound-active programs | |
| Sensitivity | SEnS | u 0–u100 | Sound sensitivity | |
| Custom Color Mixing | u-- | r. 0–255 | Custom static colors combine red, green, blue, and amber | |
| | | G. 0–255 | | |
| | | b. 0–255 | | |
| | | A. 0–255 | Strobe rate | |
| S. 0–100 | | | | |
| Bluetooth Mode* | bLE | ----- | Bluetooth control mode, displays Bluetooth ID | |
| Control Mode | SEt | ir | on | Turns infrared on or off |
| | | | oFF | |
| | | out | SLAV | Enables Master/Slave with other BT products |
| | | | dMX | Enables Master/Slave with non-BT products |

*The **Bluetooth®** word mark and logos are registered trademarks owned by the Bluetooth SIG, Inc. and any use of such marks by Chauvet & Sons, LLC is under license. Other trademarks and trade names are those of their respective owners.

Configuration (DMX)

The EZLink Par Q4BT works with a DMX controller. Information about DMX is in the CHAUVET DMX Primer, which is available from the Chauvet website:

http://www.chauvetlighting.com/downloads/DMX_Primer_rev05_WO.pdf.

Starting Address

When selecting a starting DMX address, always consider the number of DMX channels the selected DMX mode uses. If the starting address is set too high, access to some of the product’s channels could be restricted.

The EZLink Par Q4BT uses up to 8 DMX channels, which defines the highest configurable address is **505**. For information about the DMX protocol, download the DMX Primer from www.chauvetdj.com.

To select the starting address, do the following:

1. Press <MENU> repeatedly until **4Ch** or **8Ch** shows on the display.
2. Press <ENTER>.
3. Use <UP> or <DOWN> to select the starting address, from **d 1–509** (4Ch) or **d 1–505** (8Ch).
4. Press <ENTER>.

DMX Personalities

The EZLink Par Q4BT has two DMX personalities: a 4-channel personality and an 8-channel personality. To select a DMX personality, follow the instructions below.

1. Press **<MENU>** to view menu options on the display.
2. Use **<UP>** or **<DOWN>** to select the DMX personality, from **4Ch** or **8Ch**.
3. Press **<ENTER>**.

DMX Channel Assignments and Values

8Ch

| Channel | Function | Value | Percent/Setting |
|---------|---------------|-----------|-------------------------------|
| 1 | Red | 000 ⇔ 255 | 0–100% |
| 2 | Green | 000 ⇔ 255 | 0–100% |
| 3 | Blue | 000 ⇔ 255 | 0–100% |
| 4 | Amber | 000 ⇔ 255 | 0–100% |
| 5 | Strobe | 000 ⇔ 015 | No Function |
| | | 016 ⇔ 255 | Strobe, slow to fast |
| 6 | Auto Programs | 000 ⇔ 005 | No function |
| | | 006 ⇔ 055 | Auto program 1 (programs 2–7) |
| | | 056 ⇔ 106 | Auto program 2 |
| | | 107 ⇔ 157 | Auto program 3 |
| | | 158 ⇔ 208 | Auto program 4 |
| 7 | Auto Speed | 000 ⇔ 250 | Program speed, slow to fast |
| | | 251 ⇔ 255 | Sound-active program |
| 8 | Dimmer | 000 ⇔ 255 | 0–100% |

4Ch

| Channel | Function | Value | Percent/Setting |
|---------|----------|-----------|-----------------|
| 1 | Red | 000 ⇔ 255 | 0–100% |
| 2 | Green | 000 ⇔ 255 | 0–100% |
| 3 | Blue | 000 ⇔ 255 | 0–100% |
| 4 | Amber | 000 ⇔ 255 | 0–100% |

Configuration (Bluetooth)

The EZLink Par Q4BT can be operated with the BTAir application over a Bluetooth connection (Bluetooth version 4.2):

1. Download and install the BTAir app from your preferred app store.
2. Press **<MENU>** repeatedly until **bLE** shows on the display.
3. Press **<ENTER>**.

The app will find and pair automatically to all the BT series products within range.

Configuration (Standalone)

Set the product in one of the standalone modes to control without a DMX controller.



Never connect a product that is operating in any standalone mode to a DMX string connected to a DMX controller. Products in standalone mode may transmit DMX signals that could interfere with the DMX signals from the controller.

Automatic Programs

To run the EZLink Par Q4BT in automatic mode, follow the instructions below:

1. Press **<MENU>** repeatedly until **P--** shows on the display.
2. Press **<ENTER>**.
3. Use **<UP>** or **<DOWN>** to select an automatic program, from **P 1–5**.
4. Press **<ENTER>**.

Auto-Program Speed

To set the auto-program speed on the EZLink Par Q4BT, do the following:

1. Press **<MENU>** repeatedly until **S--** shows on the display.
2. Use **<UP>** or **<DOWN>** to increase or decrease the program speed, from **S. 1–100**.
3. Press **<ENTER>**. The product will return to Auto mode.

Sound-Active Mode

To run the EZLink Par Q4BT in sound-active mode, follow the instructions below:

1. Press **<MENU>** repeatedly until **Snd** shows on the display.
2. Press **<ENTER>**.
3. Use **<UP>** or **<DOWN>** to select a sound-active program, from **Snd1–5**.
4. Press **<ENTER>**.



The product will only respond to low frequencies of music (bass and drums).

Preset Color Mode

To run the EZLink Par Q4BT on a preset static color, do the following:

1. Press **<MENU>** repeatedly until **C--** shows on the display.
2. Press **<ENTER>**.
3. Use **<UP>** or **<DOWN>** to select a static color, from **C 1–15**.
4. Press **<ENTER>**.

Custom Color Mixing

To mix a custom static color on the EZLink Par Q4BT, do the following:

1. Press **<MENU>** repeatedly until **u--** shows on the display.
2. Press **<ENTER>** and one of the following will show on the display:
 - **r. ___** (red)
 - **G. ___** (green)
 - **b. ___** (blue)
 - **A. ___** (amber)
 - **S. ___** (strobe rate)
3. Press **<ENTER>** to cycle through the options.
4. Use **<UP>** or **<DOWN>** to increase or decrease the selected value, from **0–255** (for red, green, blue, or amber) or from **0–100** (for strobe rate).
 - Strobe rate - **0**: no function, **1–99**: slow to fast, **100**: sound-active.
5. Repeat steps 3 and 4 until the color is set as desired.

IRC-6 Infrared Remote Control

The EZLink Par Q4BT is compatible with the IRC-6 infrared remote control from Chauvet. To activate IR mode, follow the instructions below:

1. Press **<MENU>** repeatedly until **SEt** shows on the display.
2. Press **<ENTER>**.
3. Use **<UP>** or **<DOWN>** to select **ir**.
4. Press **<ENTER>**.
5. Use **<UP>** or **<DOWN>** to select **on**.
6. Press **<ENTER>**.

IRC-6 Operation

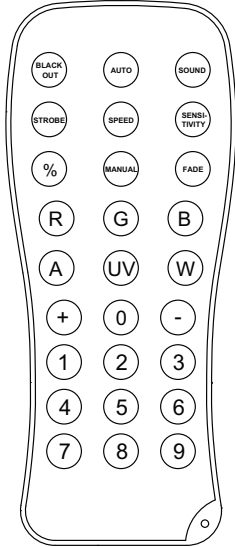

Automatic Mode

Automatic mode will enable you to run the automatic programs on the product.

To turn on Automatic mode (snap) with the IRC-6:

1. Press **<AUTO>** on the IRC-6.
2. Press **<+>** or **<->** to choose between the different auto programs.

To select only fading programs:

1. Press **<FADE>** on the IRC-6.
2. Press **<+>** or **<->** to choose between the different fading programs.

To adjust the speed of the automatic program:

1. Press **<SPEED>** on the IRC-6.
2. Press **<+>** or **<->** to increase or decrease the speed of the program.

Sound-Active Mode

To turn on Sound-Active mode with the IRC-6:

1. Press **<SOUND>** on the IRC-6.
2. Press **<+>** or **<->** to select a sound-active program.

To adjust the sound sensitivity:

1. Press **<SENSITIVITY>** on the IRC-6.
2. Press **<+>** or **<->** to increase or decrease the sensitivity.

Manual Color Control

To select a preset static color with the IRC-6:

1. Press **<MANUAL>** on the IRC-6.
2. Press any number between 0–9 to choose your color.

To manually control the RGB percentage with the IRC-6:

1. Press **<MANUAL>** on the IRC-6.
2. Select the color to be edited, from **<R>** (red), **<G>** (green), **** (blue), or **<A>** (amber).
3. Press **<+>** or **<->** to increase or decrease the value of the selected color.
4. Repeat steps 2 and 3 until the product outputs as desired.

Strobe

To adjust the strobe rate with the IRC-6:

1. Press **<STROBE>** on the IRC-6.
2. Press **<+>** or **<->** to increase or decrease the strobe rate.
3. Press **<STROBE>** again to turn off the strobe.

Dimmer

To adjust the total output with the IRC-6:

1. Press **<%>** on the IRC-6.
2. Press **<+>** or **<->** to increase or decrease the output level.

Black Out

To black out the lights with the IRC-6:

1. Press **<BLACK OUT>** on the IRC-6.

This will turn off all the lights until the button is pressed again.

The IRC-6 will not respond to any inputs when Black Out is activated. If the remote does not respond when a button is pressed, try pressing **<BLACK OUT>. You may have inadvertently activated Black Out.**



Master/Slave Mode

The Master/Slave mode allows a single EZLink Par Q4BT product (the “master”) to control the actions of one or more EZLink Par Q4BT products (the “slaves”) without the need of a DMX controller. The master product will be set to operate in standalone or with the IRC-6, while the slave products will be set to operate in slave mode. Once set and connected, the slave products will operate in unison with the master product.

Configure the products as indicated below.

Slave products:

1. Press **<MENU>** repeatedly until **4Ch** shows on the display.
2. Press **<ENTER>**.
3. Set the DMX address to **d 1**.
4. Connect the DMX input of the first slave product to the DMX output of the master product.
5. Connect the DMX input of the subsequent slave products to the DMX output of the previous slave product.
6. Finish setting and connecting all the slave products.

Master product:

1. Press **<MENU>** repeatedly until **SEt** shows on the display.
2. Press **<ENTER>**.
3. Use **<UP>** or **<DOWN>** to select **out**.
4. Press **<ENTER>**.
5. Press **<UP>** or **<DOWN>** to select **dMX** (to Master/Slave with non-BT products) or **SLAV** (to Master/Slave with other BT products).
6. Press **<ENTER>**.
7. Set the master product to operate in standalone or IR mode.
8. Make the master product the first product in the DMX daisy chain.



- **Configure all the slave products before connecting the master to the daisy chain.**
- **Never connect a DMX controller to a DMX string configured for Master/Slave operation because the controller may interfere with the signals from the master.**
- **Do not connect more than 31 slaves to the master.**

5. Maintenance

Product Maintenance

Dust build-up reduces light output performance and can cause overheating. This can lead to reduction of the light source's life and/or mechanical wear. To maintain optimum performance and minimize wear, clean your lighting products at least twice a month. However, be aware that usage and environmental conditions could be contributing factors to increase the cleaning frequency.

To clean the product, follow the instructions below:

1. Unplug the product from power.
2. Wait until the product is at room temperature.
3. Use a vacuum (or dry compressed air) and a soft brush to remove dust collected on the external surface/vents.
4. Clean all transparent surfaces with a mild soap solution, ammonia-free glass cleaner, or isopropyl alcohol.
5. Apply the solution directly to a soft, lint-free cotton cloth or a lens-cleaning tissue.
6. Softly drag any dirt or grime to the outside of the transparent surface.
7. Gently polish the transparent surfaces until they are free of haze and lint.



Always dry the transparent surfaces carefully after cleaning them.



Do not spin the cooling fans using compressed air because they could be damaged.

6. Technical Specifications

Dimensions and Weight

| Length | Width | Height | Weight |
|-----------------|-----------------|-----------------|-----------------|
| 5.7 in (145 mm) | 5.7 in (145 mm) | 5.6 in (143 mm) | 2.8 lb (1.3 kg) |

Note: Dimensions in inches rounded to the nearest decimal digit.

Power

| Power Supply Type | Range | Voltage Selection |
|-----------------------|--------------------------|-------------------|
| Switching (internal) | 100 to 240 VAC, 50/60 Hz | Auto-ranging |
| Parameter | 120 V, 60 Hz | 230 V, 50 Hz |
| Consumption | 26 W | 24 W |
| Operating current | 0.3 A | 0.2 A |
| Fuse | F 1 A, 250 V | F 1 A, 250 V |
| Power I/O | U.S./Worldwide | UK/Europe |
| Power input connector | IEC | IEC |
| Power cord plug | Edison (U.S.) | Local plug |

Light Source

| Type | Color | Quantity | Power | Current | Lifespan |
|------|--------------------|----------|-------|---------|--------------|
| LED | Quad-color RGBA | 4 | 3 W | 1 A | 50,000 hours |

Photometrics

| Strobe Rate | Beam Angle | Field Angle | Illuminance @ 2 m |
|-------------|------------|-------------|-------------------|
| 0 to 25 Hz | 15° | 34° | 1,306 lux |

Thermal

| Maximum External Temperature | Cooling System |
|------------------------------|-------------------------|
| 104 °F (40 °C) | Fan-assisted convection |

DMX

| I/O Connector | Channel Range | Optional Controllers |
|---------------|---------------|----------------------|
| 3-pin XLR | 4 or 8 | IRC-6 |

Ordering

| Product Name | Item Code | UPC Number |
|-----------------|-----------|--------------|
| EZLink Par Q4BT | 10031540 | 781462218881 |



Returns

In case you need to get support or return a product:

- If you are located in the U.S., contact Chauvet World Headquarters.
- If you are located in the U.K. or Ireland, contact Chauvet Europe Ltd.
- If you are located in Benelux, contact Chauvet Europe BVBA.
- If you are located in France, contact Chauvet France.
- If you are located in Germany, contact Chauvet Germany.
- If you are located in Mexico, contact Chauvet Mexico.
- If you are located in any other country, DO NOT contact Chauvet. Instead, contact your local distributor. See www.chauvetdj.com for distributors outside the U.S., U.K., Ireland, Benelux, France, Germany, or Mexico.



If you are located outside the U.S., UK, Ireland, Benelux, France, Germany, or Mexico, contact your distributor of record and follow their instructions on how to return Chauvet products to them. Visit our website www.chauvetdj.com for contact details.

Call the corresponding Chauvet Technical Support office and request a Return Merchandise Authorization (RMA) number before shipping the product. Be prepared to provide the model number, serial number, and a brief description of the cause for the return.

To submit a service request online, go to www.chauvetdj.com/service-request.

Send the merchandise prepaid, in its original box, and with its original packing and accessories. Chauvet will not issue call tags.

Clearly label the package with the RMA number. Chauvet will refuse any product returned without an RMA number.



Write the RMA number on a properly affixed label. DO NOT write the RMA number directly on the box.

Before sending the product, clearly write the following information on a piece of paper and place it inside the box:

- Your name
- Your address
- Your phone number
- RMA number
- A brief description of the problem

Be sure to pack the product properly. Any shipping damage resulting from inadequate packaging will be your responsibility. FedEx packing or double-boxing are recommended.



Chauvet reserves the right to use its own discretion to repair or replace returned product(s).

Contact Us

| General Information | Technical Support |
|--|--|
| Chauvet World Headquarters | |
| Address: 5200 NW 108th Ave. Sunrise, FL 33351 Voice: (954) 577-4455 Fax: (954) 929-5560 Toll Free: (800) 762-1084 | Voice: (844) 393-7575 Fax: (954) 756-8015 Email: chauvetcs@chauvetlighting.com Website: www.chauvetdj.com |
| Chauvet Europe Ltd | |
| Address: Unit 1C Brookhill Road Industrial Estate Pinxton, Nottingham, UK NG16 6NT Voice: +44 (0) 1773 511115 Fax: +44 (0) 1773 511110 | Email: UKtech@chauvetlighting.eu Website: www.chauvetdj.eu |
| Chauvet Europe BVBA | |
| Address: Stokstraat 18 9770 Kruishoutem Belgium Voice: +32 9 388 93 97 | Email: BNLtech@chauvetlighting.eu Website: www.chauvetdj.eu |
| Chauvet France | |
| Address: 3, Rue Ampère 91380 Chilly-Mazarin France Voice: +33 1 78 85 33 59 | Email: FRtech@chauvetlighting.fr Website: www.chauvetdj.eu |
| Chauvet Germany | |
| Address: Bruno-Bürgel-Str. 11 28759 Bremen Germany Voice: +49 421 62 60 20 | Email: DEtech@chauvetlighting.de Website: www.chauvetdj.eu |
| Chauvet Mexico | |
| Address: Av. de las Partidas 34 - 3B (Entrance by Calle 2) Zona Industrial Lerma Lerma, Edo. de México, CP 52000 Voice: +52 (728) 690-2010 | Email: servicio@chauvet.com.mx Website: www.chauvetdj.mx |

Visit the applicable website above to verify our contact information and instructions to request support. Outside the U.S., U.K., Ireland, Benelux, France, Germany, or Mexico, contact the dealer of the record.