

# RDM2

## User Manual

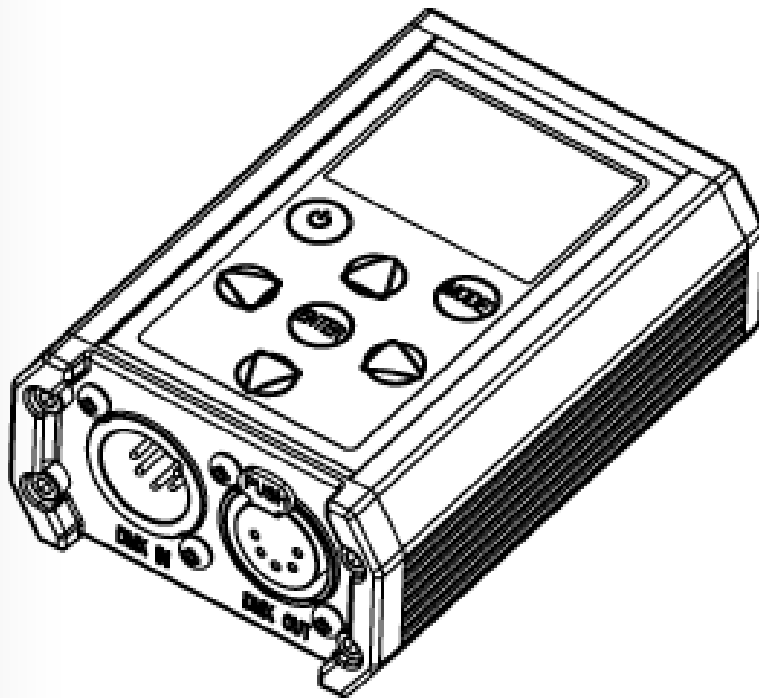

  
**CHAUVET**  
PROFESSIONAL

**Edition Notes** The RDM2go User Manual Rev. 1 includes a description, safety precautions, and installation, programming, operation, and maintenance instructions for the RDM2go as of the release date of this edition in November 2015.

**Trademarks** CHAUVET, the Chauvet logo and RDM2go are registered trademarks or trademarks of Chauvet & Sons Inc. (d/b/a Chauvet and Chauvet Lighting) in the United States and other countries. Other company and product names and logos referred to herein may be trademarks of their respective companies.

**Copyright Notice** The works of authorship contained in this manual, including, but not limited to, all design, text and images are owned by Chauvet.

© **Copyright 2015 Chauvet & Sons, Inc. All rights reserved.**

Electronically published by Chauvet in the United States of America.

**Manual Use** Chauvet authorizes its customers to download and print this manual for professional information purposes only. Chauvet expressly prohibits the usage, copy, storage, distribution, modification, or printing of this manual or its content for any other purpose without written consent from Chauvet.

**Document Printing** For better results, print this document in color, on letter size paper (8.5 x 11 in), double-sided. If using A4 paper (210 x 297 mm), configure your printer to scale the content accordingly.

**Intended Audience** Any person in charge of installing, operating, and/or maintaining this product should completely read through the guide that shipped with the product, as well as this manual, before installing, operating, or maintaining this product.

**Disclaimer** Chauvet believes that the information contained in this manual is accurate in all respects. However, Chauvet assumes no responsibility and specifically disclaims any and all liability to any party for any loss, damage or disruption caused by any errors or omissions in this document, whether such errors or omissions result from negligence, accident or any other cause. Chauvet reserves the right to revise the content of this document without any obligation to notify any person or company of such revision, however, Chauvet has no obligation to make, and does not commit to make, any such revisions..

**Document Revision** The RDM2go User Manual Rev. 1 is the first edition of this manual. Go to [www.chauvetprofessional.com](http://www.chauvetprofessional.com) for the latest version.

# Table of Contents

<b>1. Before You Begin .....</b>	<b>1</b>
What Is Included .....	1
Claims .....	1
Manual Conventions .....	1
Symbols .....	1
Safety Notes .....	2
Personal Safety.....	2
Mounting And Rigging.....	2
Power And Wiring .....	2
Operation .....	2
<b>2. Introduction .....</b>	<b>3</b>
Description .....	3
Features.....	3
Overview .....	4
Dimensions .....	5
<b>3. Setup.....</b>	<b>6</b>
DC Power.....	6
Charging the Battery .....	6
Battery Charge Notes.....	6
Storage Notes .....	6
Connection.....	7
Remote Device Management (RDM) .....	7
Ilumicode.....	7
<b>4. Operation .....</b>	<b>8</b>
Control Panel Description .....	8
Programming .....	8
Menu Map .....	9
Menu Map (Cont.) .....	10
Menu Map (Cont.) .....	11
Cable Test Chart.....	11
RDM.....	12
Ilumicode.....	12
DMX Starting Address.....	12
DMX Personality .....	12
DMX Values .....	13
Static Colors.....	13
Dimmer .....	13
Color .....	13
(Full Color Products).....	13
Whites Setting.....	13
Reset to Factory Settings.....	13
Send DMX.....	14
Channel Adjustment.....	14
Send Options .....	14
Receive DMX.....	15
View incoming DMX Values .....	15
Cable Test.....	15
Using the Cable Tester .....	15
Power Options .....	15
Using the Power Options .....	15
Information .....	15

---

<b>5. Technical Information .....</b>	<b>16</b>
Product Maintenance.....	16
<b>6. Technical Specifications.....</b>	<b>17</b>
Returns .....	18
<b>Contact Us .....</b>	<b>19</b>

# 1. Before You Begin



- What Is Included**
- RDM2go
  - Carry Pouch
  - 2 pc, 3- to 5-pin converters
  - 5-pin male to bare wire adaptor
  - USB-A Male to Micro USB-B Male (3 ft)
  - Warranty Card
  - Quick Reference Guide

**Claims** Carefully unpack the product immediately and check the box to make sure all the parts are in the package and are in good condition. If the box or the contents (the product and included accessories) appear damaged from shipping or show signs of mishandling, notify the carrier immediately, not Chauvet. Failure to report damage to the carrier immediately may invalidate your claim. In addition, keep the box and contents for inspection. For other issues, such as missing components or parts, damage not related to shipping, or concealed damage, file a claim with Chauvet within 7 days of delivery.

**Manual Conventions**

Convention	Meaning
<b>1–512</b>	A range of values in the text
<b>50/60</b>	A set of mutually exclusive values in the text
<b>&lt;SET&gt;</b>	A button on the product’s control panel
<b>Settings</b>	A product function or a menu option
<b>Mode&gt;Settings</b>	A sequence of menu options
<b>1–10</b>	A range of menu values from which to choose in a menu
<b>Yes/No</b>	A set of two mutually exclusive menu options in a menu
<b>ON</b>	A unique value to be entered or selected in a menu

**Symbols**

Symbols	Meaning
	Critical installation, configuration, or operation information. Failure to comply with this information may cause the product not to work, damage third-party equipment, or cause harm to the operator.
	Important installation or configuration information. Failure to comply with this information may keep the product from working.
	Useful information.



The term “DMX” used throughout this manual refers to the USITT DMX512-A digital data transmission protocol.

### Safety Notes

Read all the following Safety Notes before working with this product. These notes include important information about the installation, usage, and maintenance of this product.



**This product contains no user-serviceable parts. Any reference to servicing in this User Manual will only apply to properly trained Chauvet certified technicians. Do not open the housing or attempt any repairs.**



**All applicable local codes and regulations apply to proper installation of this product.**

### Personal Safety

- Always disconnect this product from its power source before servicing.
- Always connect this product to a grounded circuit to avoid the risk of electrocution.
- The product is not intended for permanent installation.

### Mounting And Rigging

- This product is for indoor use only! To prevent risk of fire or shock, do not expose this product to rain or moisture. (IP20)
- CAUTION: When transferring product from extreme temperature environments, (e.g. cold truck to warm humid ballroom) condensation may form on the internal electronics of the product. To avoid causing a failure, allow product to fully acclimate to the surrounding environment before connecting it to power.

### Power And Wiring

- Make sure there are no flammable materials close to this product while it is operating.
- Always make sure you are connecting this product to the proper voltage in accordance with the specifications in this manual or on the product's specification label.
- To eliminate unnecessary wear and improve its lifespan, during periods of non-use completely disconnect the product from power via breaker or by unplugging it.
- Never connect this product to a dimmer pack or rheostat.
- Never disconnect this product by pulling or tugging on the power cable.

### Operation

- Do not operate this product if you see damage on the housing, lenses, or cables. Have the damaged parts replaced by an authorized technician at once.
- Do not cover the ventilation slots when operating to avoid internal overheating.
- The maximum ambient temperature is 113 °F (45 °C). Do not operate this product at a higher temperature.
- In case of a serious operating problem, stop using this product immediately!



**In the unlikely event that your Chauvet product requires service, contact Chauvet Technical Support.**

## 2. Introduction

**Description** The RDM2go is a multi-functional tool for working with lighting products over a DMX/RDM data line. The palm-sized controller performs a multitude of tasks including RDM functionality, DMX snapshot, test-scene record/playback, Ilumicode addressing for Iluminarc fixtures, and DMX input/output monitoring. The RDM2go also features a built in DMX cable integrity checker, and an easy to read OLED display. The RDM2go easily recharges via a standard micro USB jack and comes with a convenient carry pouch and connector convertors.

- Features**
- Control Protocol: DMX, RDM, Ilumicode
  - DMX Channels: 1, 2, 3, 4, 5, 6 or 7
  - Modes/Personalities (Ilumicode): 13 personalities (ARC 1, ARC 1+D, ARC2, ARC2+D, ARC3, ARC3+D, ARC FULL, REMOTE, SOLID, SPECIAL1, SPECIAL2, VW, VW+D)
  - Handheld tool for managing products and systems with DMX, RDM, and Ilumicode based control
  - Easily address, locate and monitor RDM capable fixtures
  - Check DMX addressing, cabling, and store/playback basic snapshots
  - Address and set personalities of Ilumicode based architectural fixtures
  - Easy to read, large OLED display and easy to navigate menus
  - Comes with connector adaptors, USB charging cord and belt clip pouch

## Overview

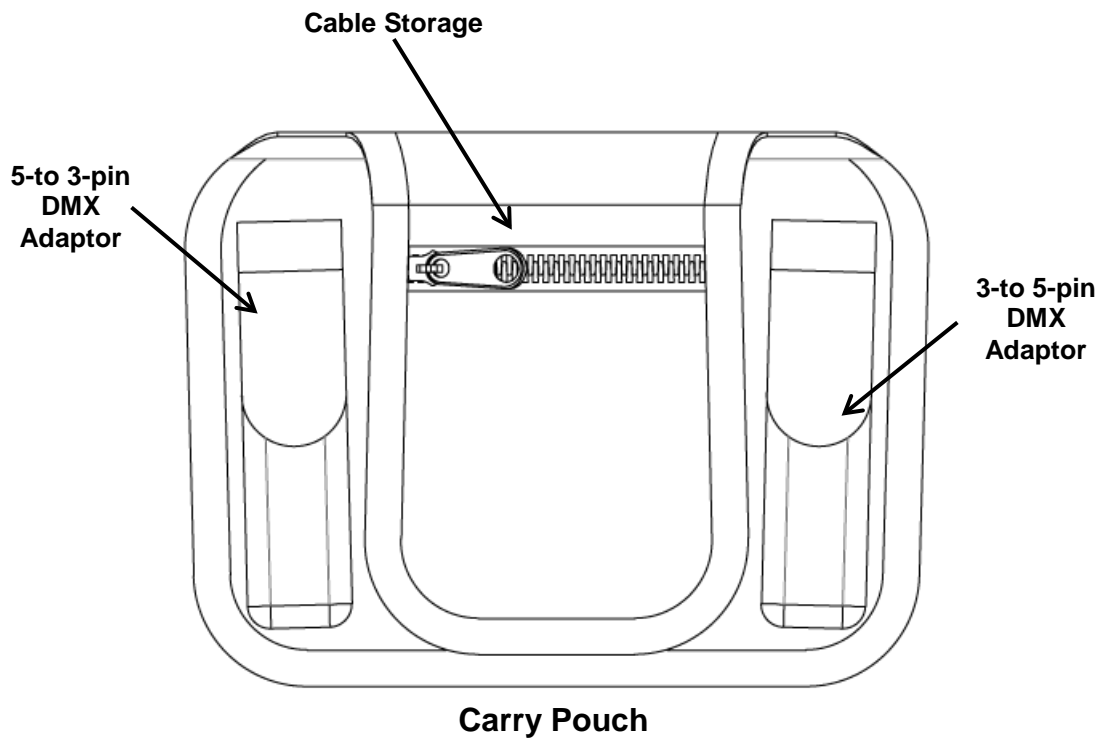
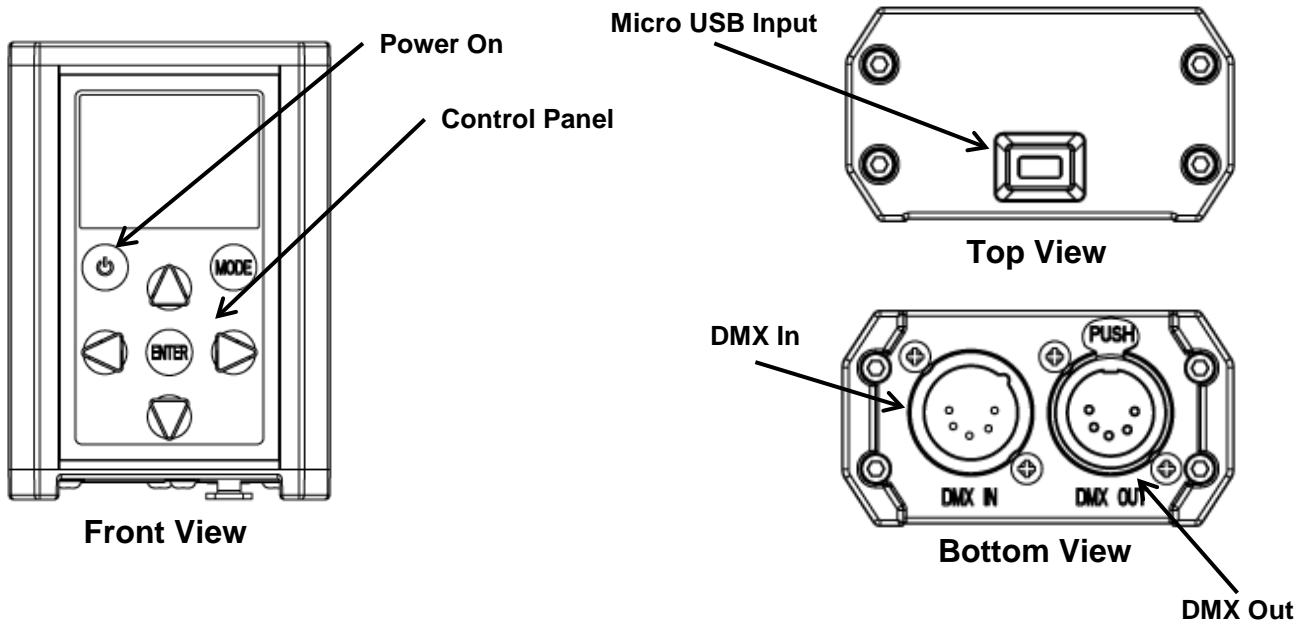



### Dimensions

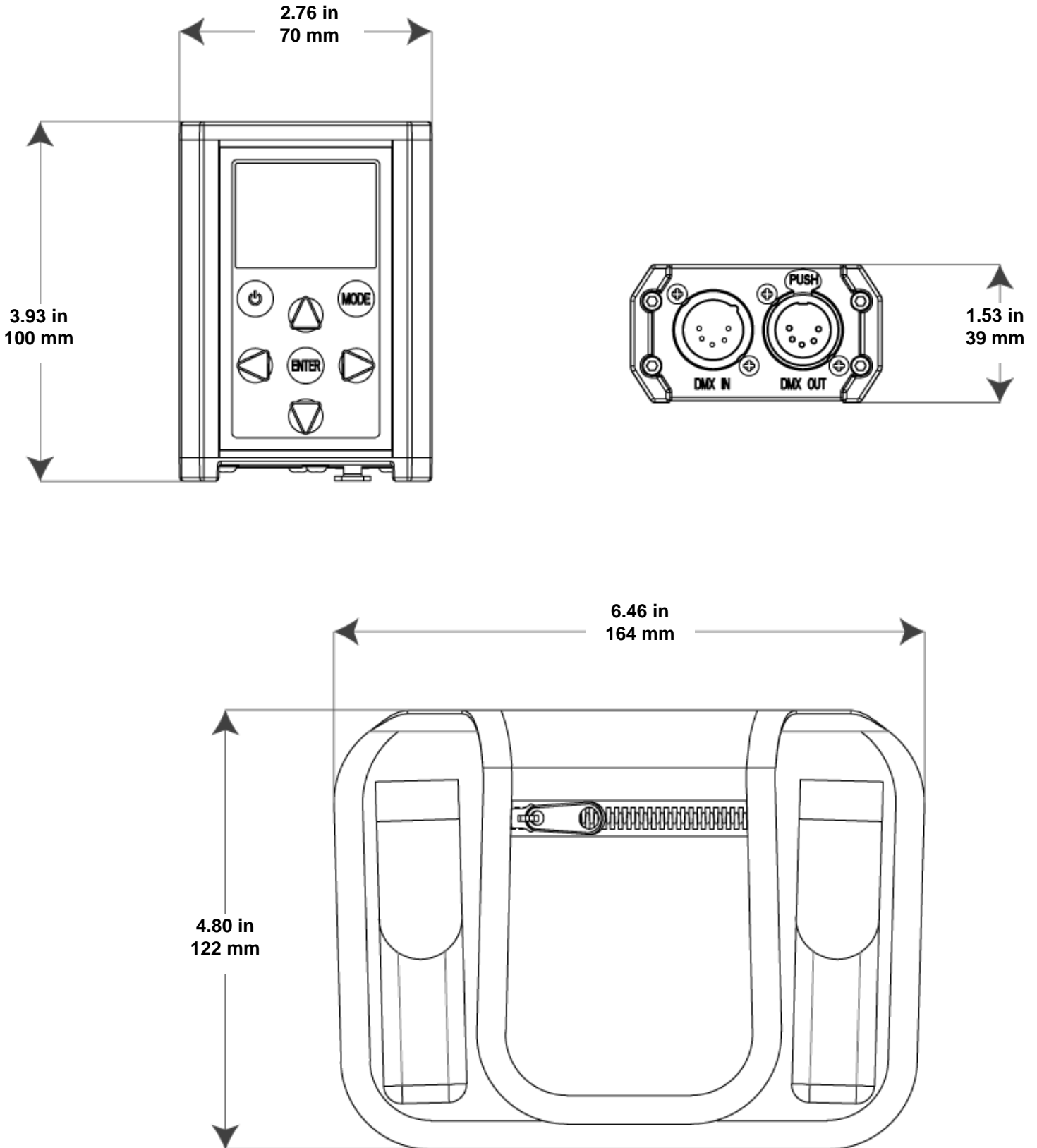

## 3. Setup

**DC Power** This product operates on a rechargeable lithium ion battery.

**Charging the Battery** To recharge the product:

1. Plug the included cable into any USB-A female outlet.
2. Plug the Micro USB-B male end into the female socket located on top of the product.

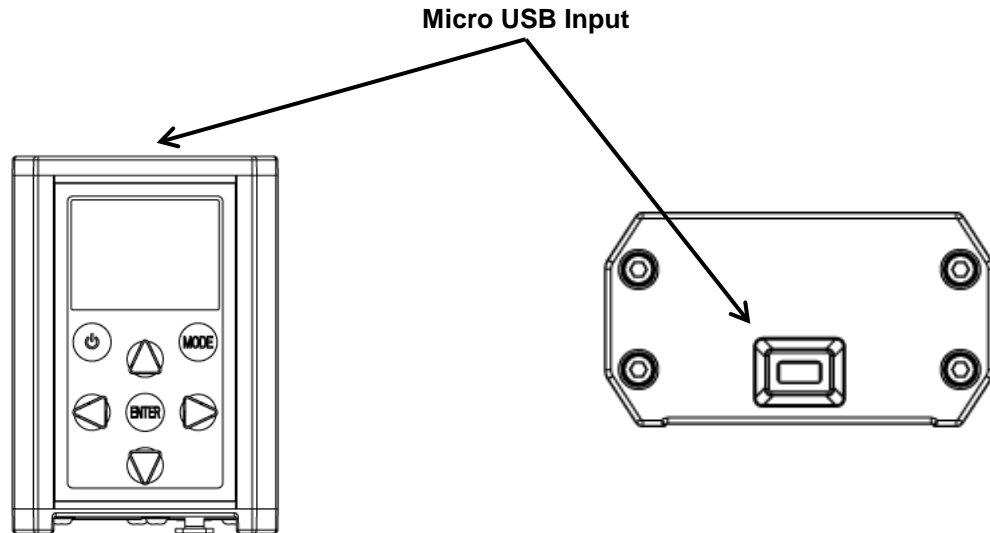

- To eliminate unnecessary wear and improve its lifespan, during periods of non-use completely disconnect the product from power by unplugging it.
- When storing product for long periods of time without charging or using, only charge product to 50% and store in a cool dry environment.

**Battery Charge Notes** This product is equipped with a built-in rechargeable lithium ion battery.

- Recharge the battery within three days of last use.
- Avoid depleting the battery below 10%.
- Recharge/discharge the battery to 50% capacity before storing this product for extended periods of time.
- For best results, charge the battery in a temperature between 32 °F (0 °C), and 95 °F (35 °C).
- When charging the battery, keep the product at least 1 m from any open flame or hot plate.
- Perform a full discharge/recharge cycle every three months.
- If the battery is completely discharged, the device cannot be turned on immediately when the charger is connected. Allow a depleted battery to charge for a few minutes before turning on the device.
- The device can be used while it is charging, but it may take longer to fully charge the battery.
- While charging, the device may heat up. This is normal and should not affect the device's lifespan or performance. If the battery gets hotter than usual, the charger may stop charging.
- Lithium-Ion batteries continue to slowly discharge (self-discharge) when not in use or while in storage. Routinely check the battery's charge status

**Storage Notes**

- Store charged product(s) in a dry environment, away from direct sunlight.
- Charge or discharge the battery to approximately 50% of capacity at least once every six months.
- Charge or discharge the battery to approximately 50% of capacity before storage.
- Store the battery at temperatures between 41 °F and 68 °F (5 °C and 20 °C).

## Connection

You can link the RDM2go to other DMX controlled products using a 5-pin DMX connection. If using other DMX-compatible products with the RDM2go, you can control each individually with a single DMX controller.



**If you are not familiar with or need more information about DMX standards, Master/Slave connectivity, or the DMX cables needed to link this product to a DMX controller, download the DMX Primer from the Chauvet website: [www.chauvetprofessional.com](http://www.chauvetprofessional.com).**







## Remote Device Management (RDM)

Remote Device Management, or RDM, is a standard for allowing DMX-enabled devices to communicate bi-directionally along existing DMX cabling. Check the DMX controller's User Manual or with the manufacturer as not all DMX controllers have this capability. The RDM2go supports RDM protocol that allows feedback to make changes to multiple attributes of RDM-enabled products. Please refer to the [RDM](#) section in this User Manual for more detailed examples explaining how to use this function.

## Ilumicode

The RDM2go will work as an Ilumicode addresser using the 5-pin DMX serial connection located at the bottom of the product and using the various adaptors included with this product and your Iluminarc product. Download the Ilumicode User Manual from [www.iluminarc.com](http://www.iluminarc.com) for more information about connecting and configuring the product for Ilumicode operation.

## 4. Operation

Control Panel Description	Button	Function
		Turns product On/Off
		Scrolls through main level mode options and exits from the current menu or function
		Enables the currently displayed menu or sets the currently selected value into the selected function
		Navigates upwards through the menu list or increases the numeric value when in a function
		Navigates downwards through the menu list or decreases the numeric value when in a function
		Navigates left through the menu list.
		Navigates right through the menu list.

**Programming** Refer to the [Menu Map](#) to understand the menu options. The menu map shows the main level and a variable number of programming levels for each option.

- To go to the main menu level, press **<MODE>** repeatedly until the option shows on the display. Press **<ENTER>** to select. This will take you to the first programming level for that option.
- To select an option or value within the current programming level, press **<UP>** or **<DOWN>** until the option shows on the display. Press **<ENTER>** to select. In this case, if there is another programming level, you will see that first option, or you will see the selected value.
- Press **<MODE>** repeatedly to exit to the previous level.

## Menu Map

Main Level	Programming Levels			Description	
RDM	<b>No Fixtures Found!</b>			No RDM compatible products connected to the RDM2go	
	Discovering...	* (choose from list of products connected)	* (choose from the attributes unique to each product)	Shows information about each product. Some attributes will allow changes to be made. See each individual products' User Manual and the <a href="#">RDM</a> section of this Manual to determine which attributes are controllable	
Ilumicode	Start Address		001–512	Sets the DMX starting address	
	PERSON		VW	2-channel: WW, CW control	
			VW+D	3-channel: WW, CW control + dimmer	
			ARC 1	3-channel: RGB control	
			ARC 1 + D	4-channel: RGB control + dimmer	
			ARC2	4-channel: RGBW(A) control	
			ARC2 + D	5-channel: RGBW(A) control + dimmer	
			ARC3	5-channel: RGBWA control	
			ARC3 + D	6-channel: RGBWA control + dimmer	
			ARC FULL	7-channel: RGB control + dimmer	
			REMOTE	Reserved for future use	
			SOLID	1-channel: Dimmer	
			SPECIAL 1	See each product's User Manual	
	SPECIAL 2				
CALIB	WHITE	01–11	RED	000–255	Determines the white balance for the color macros
			GREN		
BLUE					
COOL					
WARM					
	RGBTOW		AMBE		Determines the white balance when <b>RGBTOW</b> is active
DIMMER			OFF		Dimmer works in linear mode
			DIM 1	Dimmer works in non-linear mode, from fast to slow	
			DIM 2		
			DIM 3		
			DIM 4		

### Menu Map (Cont.)

Main Level	Programming Levels				Description	
Ilumicode (Cont.)	STATIC	RED	000–255		Configures the static color	
		GREN				
		BLUE				
		COOL				
		WARM				
		AMBE				
		SOLD				
	STRB	00–20		Configures strobe speed		
	SETTINGS	COLOR	OFF		Maximum output, unbalanced white	
			RGBTOW		White output is as per <b>CALIB &gt; RGBTOW</b> settings	
UC				Output matches that of product's previous versions		
RESET		NO/YES		Restores factory defaults		
Send DMX	T001 – T512	000– 255  (000 – 100)	Edit Mode		Normal	Adjust each channel individually
					All	Adjust all channels together in preconfigured increments.
			Show Level As		Decimal	Determines how the dimmer levels are displayed on the screen
					Percent	
		Clear All Channels				Sets all channels to "0"
		Dmx Sequence	Play Sequence	Up/ Down: Speed	0.1"–60.0"	Uses Up/Down keys to adjust the Speed of the sequence
				Left/ Right: Fade		Uses Left/Right keys to adjust the Fade Time of each step in the sequence
			Enter: Play/Stop			Plays the DMX sequence
		Edit Sequence	Step 001 – 100	Scene End Of Sequence – 032		Set-up and edit the DMX sequence
		Delete Sequence		No/Yes		Deletes/reset the DMX sequence
		Store Scene		Scene		Records current DMX values
		Load Scene		1–32		Loads a previously recorded scene

### Menu Map (Cont.)

Main Level	Programming Levels		Description
Receive DMX	R001–R512	Show Level As	Decimal Percent
		Store Scene	Scene 1–32
Load Scene	Playing Scene 1–32	Scene 1–32	Loads a previously recorded scene
Cable Test	In ————— Out		Tests the cable for any breaks or shorts in the line. See <a href="#">Cable Test Chart</a>
Power Options	Off		Power saver feature is turned off
	1 Minute		Product is powered off after 1 min of inactivity
	5 Minute		Product is powered off after 5 min of inactivity
	10 Minute		Product is powered off after 10 min of inactivity

### Cable Test Chart

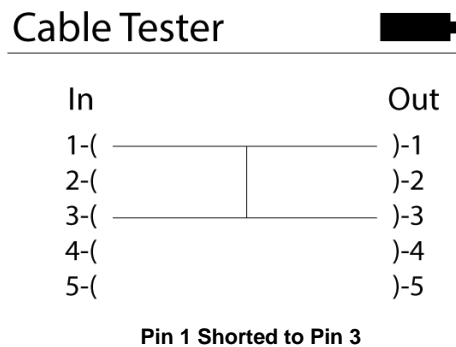
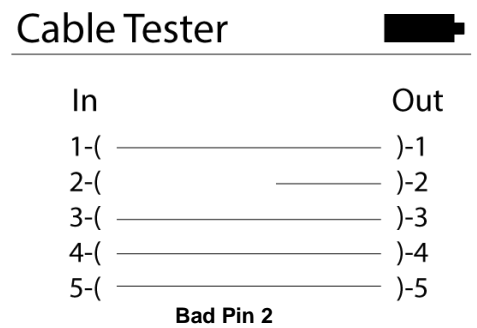
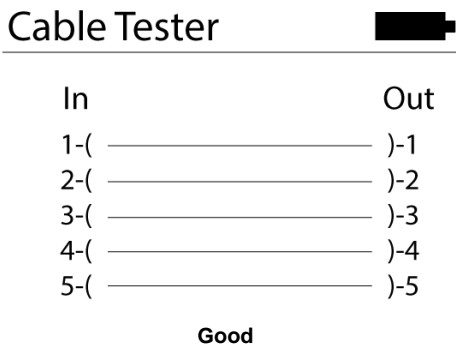

**RDM** The RDM2go uses Remote Device Management (RDM) software that allows feedback to make changes to connected RDM compatible products.

1. Go to the **RDM** main level.
2. The RDM2go will scan for RDM compatible products, **Discovering...** will display on the screen.
  - a. **No Fixtures Found** – No RDM compatible products were found. Be sure your connected products are RDM compatible check all connections and try again.
3. Select from the list of RDM compatible products displayed.
4. Select and adjust each of the available of attributes.

**RDM Product Attributes** Below are some examples of more common attributes that will be listed on the LCD after choosing from the list of available RDM compatible products. Each of these attributes may or may not be changeable depending on each type of individual product.

- **Label:** Allows user input such as identity information to be stored on the products memory.
- **Model:** This is the name of the product that was entered at the factory level. This attribute cannot be changed.
- **Man.:** Manufacture identity. This attribute cannot be changed.
- **Start Address:** Shows current DMX address and allows the user to change it.
- **Pers.:** Shows current product personality and allows user to change it.
- **DMX Slots:** Shows how many DMX addresses that products personality takes up. This attribute cannot be changed.
- **Slot Options:** Gives a description of what each channel in that DMX personality does. This attribute may not be available on all products.
- **Moving Light Options:** Gives options like P/T invert and P/T Swap. This attribute may not be available on all products.
- **Sensors Menu:** Shows information from the different sensors like the temperature of product
- **Display Options:** Allows user input to change the backlight level and direction of the products display and allows user to change the address.

For more information about RDM protocol and associated attributes, go to [www.openlighting.org](http://www.openlighting.org).

**Ilumicode** This Main Level selection contains all the parameters for all the compatible ILUMINARC products it can control. Consult the corresponding product's user manual to determine which parameters on the Ilumicode V 2.21 apply to that specific product.

**DMX Starting Address**

1. Go to **lumicode > Start Address**.
2. Select a starting DMX address (**001–512**).
3. Press **<ENTER>** to send the new DMX address to the product. The display will show **"SEND..."**

**DMX Personality**

1. Go to **lumicode > PERSON** and select any DMX personality.
2. Make sure to rearrange the DMX addresses of all products in the current DMX universe to avoid address overlapping.



**DMX Values** Refer to the compatible ILUMINARC product’s manual for the DMX Values that correspond to that particular product.



- **To change the DMX address of a single product, make sure that there is no other product connected to the DMX cable.**
- **Some personalities on this list may not apply to your ILUMINARC product. Consult the product’s manual for more information.**

**Static Colors**

1. Go to **lumicode > STATIC**.
2. Select a color or effect (**RED, GREN, BLUE, COOL, WARM, AMBE, SOLD, or STRB**).
3. Select a color value (**000–255**) or a strobe frequency (**00–20**).

**Dimmer** This setting gives the user four different options to simulate the dimming curve of an incandescent lighting product.

1. Go to **lumicode > DIMMER**.
2. Select a dimming curve (**OFF** or **DIM1–4**).

**Procedure:**

DIMMER	Description
<b>OFF</b>	Dimmer curve is linear with fader
<b>DIM1</b>	Non-linear (fastest)
<b>DIM2</b>	Non-linear (fast)
<b>DIM3</b>	Non-linear (slow)
<b>DIM4</b>	Non-linear (slowest)

- Color** (Full Color Products)
1. Go to **lumicode > SETTINGS > COLOR**.
  2. Select the color method (**OFF, RGBTOW, UC**).

**Details:**

**OFF**

- When the RGB faders are all set to “**255**,” the output is maximum.

**RGBTOW**

- When the RGB faders are all set to “**255**,” the output is the selected White color (see [Whites Setting](#)).

**UC**

- When the RGB faders are all set to “**255**,” the output matches the same color output of previous versions of this product.

**Whites Setting**

1. Go to **lumicode > CALIB**.
2. Select a white color (**WHITE 1–11**) or **RGB TO W**.
3. Select an RGB color (**RED, GREN, BLUE, COOL, WARM, or AMBE**).
4. Configure the color value (**000–255**).
5. Repeat steps 3 and 4 for the other RGB colors to obtain a white color.
6. Repeat steps 2 through 5 for the other white colors.

**Reset to Factory Settings**

1. Go to **lumicode > SETTINGS > RESET**.
2. Select an option (**YES/NO**).

**Details:**

The product will assume its default values as per the corresponding manual.

**Send DMX** This Main Level selection is a single universe of DMX. This allows control each of the 512 channels individually or all channels at the same time. Other features include:

- The ability to show levels on the screen as percentages or DMX values.
- Store and recall up to 32 different static scenes
- Create a sequence up to 100 steps using 32 scenes with adjustable fade and speed.

**Channel Adjustment**

1. Go to **Send DMX**.
2. Select a channel (**T001–T512**).
3. Choose a DMX Value (**000–255**)
4. Repeat Steps 2 and 3 for additional channel adjustment.



In **Step #3** of the [Channel Adjustment](#) section, the values may appear as percentages and/or the values of every channel may change when trying to adjust only 1 channel. Refer to the [Send Options](#) section to change these settings.

**Send Options** This programming level gives you various customization and programming options.

1. Go to **Send DMX**.
2. Press **<ENTER>** twice to get to the Send Options menu level.

**Edit Mode**

1. Go to **Send DMX**.
2. Press **<ENTER>** twice.
3. Go to **Edit**.
4. Press **<ENTER>** to choose **All** or **Normal**.

**Show Level As**

1. Go to **Send DMX**.
2. Press **<ENTER>** twice.
3. Go to **Show Level As**.
4. Press **<ENTER>** to choose **Decimal** or **Percent**.

**Clear All Channels**

1. Go to **Send DMX**.
2. Press **<ENTER>** twice.
3. Go to **Clear All Channels**.
4. Press **<ENTER>** to clear. This will bring you back to the Send DMX level.

**Dmx Sequence**

1. Go to **Send DMX**.
2. Press **<ENTER>** twice.
3. Go to **Play Sequence**.
4. Press **<ENTER>** to play/stop sequence.
5. Press **<UP>** or **<DOWN>** to adjust the speed between steps.
6. Press **<LEFT>** or **<RIGHT>** to adjust the fade time which is the time it takes for each step to fade up to 100% and fade down to 0.

**Store Scene**

1. Go to **Send DMX**.
2. Press **<ENTER>** twice.
3. Go to **Store Scene**.
4. Press **<ENTER>**.
5. Press **<UP>** or **<DOWN>** to choose a scene (**Scene 1– Scene 32**).
6. Select a channel (**T001–T512**).
7. Choose a DMX Value (**000–255**)
8. Press **<ENTER>**
9. Repeat Steps 3 through 8 for additional channel adjustment.



The RDM2go stores the last scene that was changed. To start with a clean scene, refer to [Clear All Channels](#) section to set all the DMX channels to 0.

- Load Scene**
1. Go to **Send DMX**.
  2. Press **<ENTER>** twice.
  3. Go to **Load Scene**.
  4. Press **<ENTER>**.
  5. Press **<UP>** or **<DOWN>** to choose a scene (**Scene 1– Scene 32**).

**-OR-**

1. Go to **Load Scene**.
2. Press **<ENTER>** twice.
3. Press **<UP>** or **<DOWN>** to choose a scene (**Scene 1– Scene 32**).

**Receive DMX** This Main Level selection displays incoming DMX values for each channel and allows those values to be recorded as a scene to be played back later.

- View incoming DMX Values**
1. Go to **Receive DMX**.
  2. Press **<ENTER>**.

- Show Level As**
1. Go to **Receive DMX**.
  2. Press **<ENTER>** twice.
  3. Go to **Show Level As**.
  4. Press **<ENTER>** to choose **Decimal** or **Percent**.

- Store Scene**
1. Go to **Receive DMX**.
  2. Press **<ENTER>** twice.
  3. Go to **Store Scene**.
  4. Press **<ENTER>** to record the current input as a scene.

**Cable Test** This Main Level selection tests data cables for continuity. Use the [Cable Test Chart](#) to determine which cables are good and which are in need of repair.

- Using the Cable Tester**
1. Plug both ends of a DMX cable into the RDM2go.
  2. Go to **Cable Test**.
  3. Press **<ENTER>**.

**Power Options** This Main Level selection sets the amount of time the RDM2go remains turned on after the last user input. This auto-off option can be set to **1 Minute**, **5 Minute**, **10 Minute**, or **Off**. Choosing **Off** means the product will stay on until the battery is exhausted.

- Using the Power Options**
1. Go to **Power Options**.
  2. Press **<ENTER>**.
  3. Choose the amount of time you want the product to stay on (**1 Minute**, **5 Minute**, **10 Minute**, or **Off**).
  4. Press **<ENTER>** to record the current input as a scene.

**Information** This Main Level selection provides information about current software and the products unique identification code.

## 5. Technical Information

### Product Maintenance

To maintain optimum performance and minimize wear, clean this product frequently. Usage and environment are contributing factors in determining the cleaning frequency.

As a rule, clean this product at least twice a month. Dust build-up reduces light output performance and can cause overheating. This can lead to reduced light source life and increased mechanical wear.

To clean your product:

1. Unplug the product from power.
2. Wait until the product is at room temperature.
3. Use a vacuum (or dry compressed air) and a soft brush to remove dust collected on the external vents.
4. Clean all external surfaces with a mild solution of non-ammonia glass cleaner or isopropyl alcohol.
5. Apply the solution directly to a soft, lint-free cotton cloth or a lens cleaning tissue.
6. Wipe any dirt or grime to the outside edges of the lens surface.
7. Gently polish the lens surfaces until they are free of haze and lint.



**Always dry the external surfaces thoroughly and carefully after cleaning them.**

## 6. Technical Specifications

<b>Dimensions and Weight</b>	<b>Length</b>	<b>Width</b>	<b>Height</b>	<b>Weight</b>
	2.76 in (70 mm)	1.52 in (39 mm)	3.92 in (100 mm)	0.77 lb (0.35 kg)
<b>Note:</b> Dimensions in inches rounded to the nearest decimal digit.				
<b>Power</b>	<b>Power Supply Type</b>	<b>Battery Life</b>		<b>Battery Power</b>
	Lithium Ion Battery	8 hours		3.7 V, 1,200 mAh
	<b>Parameter</b>	<b>120 VAC, 60 Hz</b>		<b>230 VAC, 50 Hz</b>
	Consumption	18 W		18 W
	Current	0.15 A		0.08 A
	<b>Power I/O</b>	<b>U.S./Canada</b>		<b>Worldwide</b>
	Power input connector	Micro USB-B		Micro USB-B
Power cord plug	USB-A Male		USB-A Male	
<b>Thermal</b>	<b>Max. External Temperature</b>	<b>Cooling System</b>		
	113 °F (45 °C)	Convection		
<b>DMX</b>	<b>I/O Connectors</b>	<b>Connector Type</b>		
	5-pin XLR	Sockets		
<b>Ordering</b>	<b>Product Name</b>	<b>Item Code</b>	<b>UPC Number</b>	
	RDM2go	03081093	781462214418	



**Returns** You must send the product prepaid, in the original box, and with the original packing and accessories. Chauvet will not issue call tags.

Call Chauvet and request a Return Merchandise Authorization (RMA) number before shipping the product. Be prepared to provide the model number, serial number, and a brief description of the cause(s) for the return.

Clearly label the package with an RMA number. Chauvet will refuse any product returned without an RMA number.



**DO NOT write the RMA number directly on the box. Instead, write it on a properly affixed label.**

Once you have received the RMA number, include the following information on a piece of paper inside the box:

- Your name
- Your address
- Your phone number
- The RMA number
- A brief description of the problem(s)

Be sure to pack the product properly. Any shipping damage resulting from inadequate packaging will be the customer's responsibility. FedEx packing or double-boxing is recommended.



**Chauvet reserves the right to use its own discretion to repair or replace returned product(s).**

# Contact Us

## USA WORLD HEADQUARTERS

### General Information – Chauvet

Address: 5200 NW 108th Avenue  
Sunrise, FL 33351

Voice: (954) 577-4455

Fax: (954) 929-5560

Toll free: (800) 762-1084

### Technical Support

Voice: (954) 577-4455 (Press 4)

Fax: (954) 756-8015

Email: [tech@chauvetlighting.com](mailto:tech@chauvetlighting.com)

**World Wide Web** [www.chauvetlighting.com](http://www.chauvetlighting.com)

## EUROPE

### General Information - Chauvet Europe BVBA

Address: Stokstraat 18  
9770 Kruishoutem  
Belgium

Voice: +32 9 388 93 97

### Technical Support

Email: [Eutech@chauvetlighting.eu](mailto:Eutech@chauvetlighting.eu)

**World Wide Web** [www.chauvetlighting.eu](http://www.chauvetlighting.eu)

### General Information - Chauvet Europe Ltd.

Address: Unit 1C  
Brookhill Road Industrial Estate  
Pinxton, Nottingham, UK  
NG16 6NT

Voice: +44 (0)1773 511115

Fax: +44 (0)1773 511110

### Technical Support

Email: [uktech@chauvetlighting.com](mailto:uktech@chauvetlighting.com)

**World Wide Web** [www.chauvetlighting.co.uk](http://www.chauvetlighting.co.uk)

## MEXICO

### General Information - Chauvet Mexico

Address: Av. Santa Ana 30  
Parque Industrial Lerma  
Lerma, Mexico C.P. 52000

Voice: +52 (728) 285-5000

### Technical Support

Email: [servicio@chauvet.com.mx](mailto:servicio@chauvet.com.mx)

**World Wide Web** [www.chauvet.com.mx](http://www.chauvet.com.mx)

Outside the U.S., United Kingdom, Ireland, Mexico, or Benelux contact the dealer of record. Follow their instructions to request support or to return a product. Visit our website for contact details.