



FlareCON Air 2

User Manual

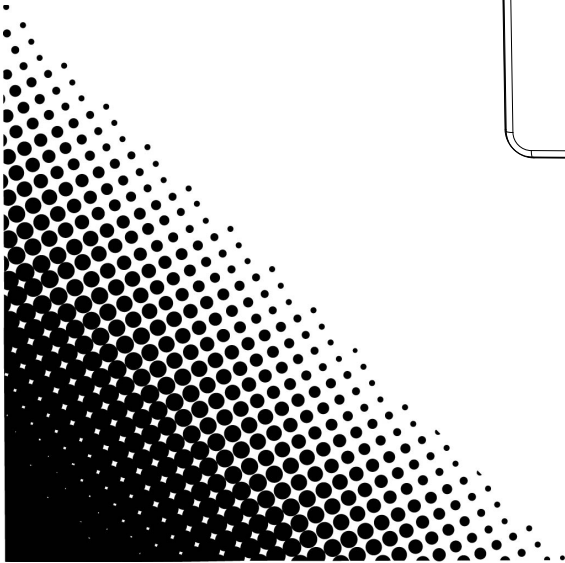
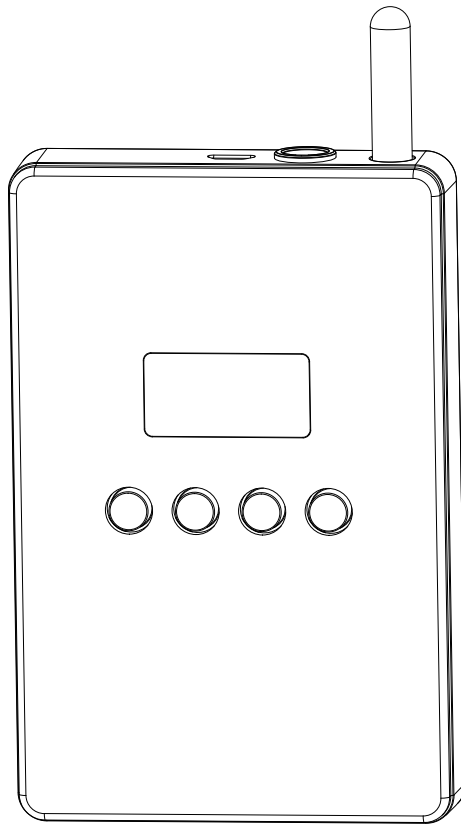

TABLE OF CONTENTS

1. Before You Begin	1
What Is Included	1
Unpacking Instructions	1
Claims	1
Text Conventions	1
Symbols	1
Disclaimer	1
Intellectual Property	1
Safety Notes.....	2
2. Introduction	3
Product Overview	3
Product Dimensions	4
3. Setup	5
AC Power.....	5
Battery Power.....	5
Charging the Battery	5
Battery Life Indicator	5
Mounting	6
Orientation.....	6
Rigging.....	6
4. Operation	7
Control Panel Operation.....	7
Menu Map	7
Using FlareCON Air 2.....	8
Wireless D-Fi Signals.....	8
DMX Signals from a Controller via Cable.....	9
Wireless Control with DMX Products	9
Setting Up Products with FlareCON Air 2	10
Configuring FlareCON Air 2	11
Selecting A Channel	11
Selecting a Signal Input Mode.....	11
Connecting to a Mobile Device.....	11
Finding the Name of FlareCON Air 2 Wi-Fi™	12
Connecting to FlareCON Air 2 Wi-Fi™	12
Connecting to a DMX Controller.....	12
Controlling DMX Lights with D-Fi Hub.....	12
5. Maintenance.....	13
Product Maintenance	13
6. Technical Specifications	14
Returns	15
Contact Us	16

1. Before You Begin

What Is Included

- FlareCON Air 2
- External Power Supply
- USB Cable
- DMX Adapter
- Quick Reference Guide

Unpacking Instructions

Carefully unpack the product immediately and check the container to make sure all the parts are in the package and are in good condition.

Claims





If the box or the contents (the product and included accessories) appear damaged from shipping, or show signs of mishandling, notify the carrier immediately, not Chauvet. Failure to report damage to the carrier immediately may invalidate your claim. In addition, keep the box and contents for inspection.

For other issues, such as missing components or parts, damage not related to shipping, or concealed damage, file a claim with Chauvet within 7 days of delivery.

Text Conventions

Convention	Meaning
1–512	A range of values
50/60	A set of values of which only one can be chosen
Settings	A menu option not to be modified
Menu > Settings	A sequence of menu options to be followed
<ENTER>	A button to be pressed on the product's control panel
ON	A value to be entered or selected

Symbols

Symbol	Meaning
	Electrical warning. Not following these instructions may cause electrical damage to the product, accessories, or the user.
	Critical installation, configuration, or operation information. Not following these instructions may make the product not work, cause damage to the product, or cause harm to the operator.
	Important installation or configuration information. The product may not function correctly if this information is not used.
	Useful information.

Disclaimer

Chauvet believes that the information contained in this manual is accurate in all respects. However, Chauvet assumes no responsibility and specifically disclaims any and all liability to any party for any loss, damage or disruption caused by any errors or omissions in this document, whether such errors or omissions result from negligence, accident or any other cause. Chauvet reserves the right to revise the content of this document without any obligation to notify any person or company of such revision, however, Chauvet has no obligation to make, and does not commit to make, any such revisions. Download the latest version from www.chauvetdj.com.

Intellectual Property

The works of authorship contained in this manual, including, but not limited to, all design, text and images are owned by Chauvet.

© Copyright 2019 Chauvet & Sons, LLC. All rights reserved.

Electronically published by Chauvet in the United States of America.

CHAUVET, the Chauvet logo, and FlareCON Air 2 are registered trademarks or trademarks of Chauvet & Sons LLC (d/b/a Chauvet and Chauvet Lighting) in the United States and other countries. Other company and product names and logos referred to herein may be trademarks of their respective companies.

Safety Notes



- Always connect the product to a grounded circuit to avoid the risk of electrocution.
- Always disconnect the product from the power source before cleaning or replacing the fuse.
- Avoid direct eye exposure to the light source while the product is on.
- Make sure the power cord is not crimped or damaged.
- Never disconnect the product from power by pulling or tugging on the cord.
- Make sure there are no flammable materials close to the product when operating.
- Do not touch the product's housing when operating because it may be very hot.
- Do not charge the battery of the product in a closed case or container.

- The product is not intended for permanent installation.
- The voltage of the outlet to which you are connecting this product must be within the range stated on the decal or rear panel of the product.
- This product is for indoor use only! (IP20) To prevent risk of fire or shock, do not expose this product to rain or moisture.
- Be sure that no ventilation slots on the product's housing are blocked.
- Never connect the product to a dimmer or rheostat.
- Make sure to replace the fuse with another of the same type and rating.
- Never carry the product from the power cord or any moving part.
- The maximum ambient temperature is 104 °F (40 °C). Do not operate this product at higher temperatures.
- In the event of a serious operating problem, stop using the product immediately.
- Never attempt to repair the product. Repairs carried out by unskilled people can lead to damage or malfunction. Please contact the nearest authorized technical assistance center.
- To eliminate unnecessary wear and improve its lifespan, during periods of non-use completely disconnect the product from power via breaker or by unplugging it.



Keep this User Manual for future use. If the product is sold to someone else, be sure that they also receive this document.

2. Introduction

Product Overview

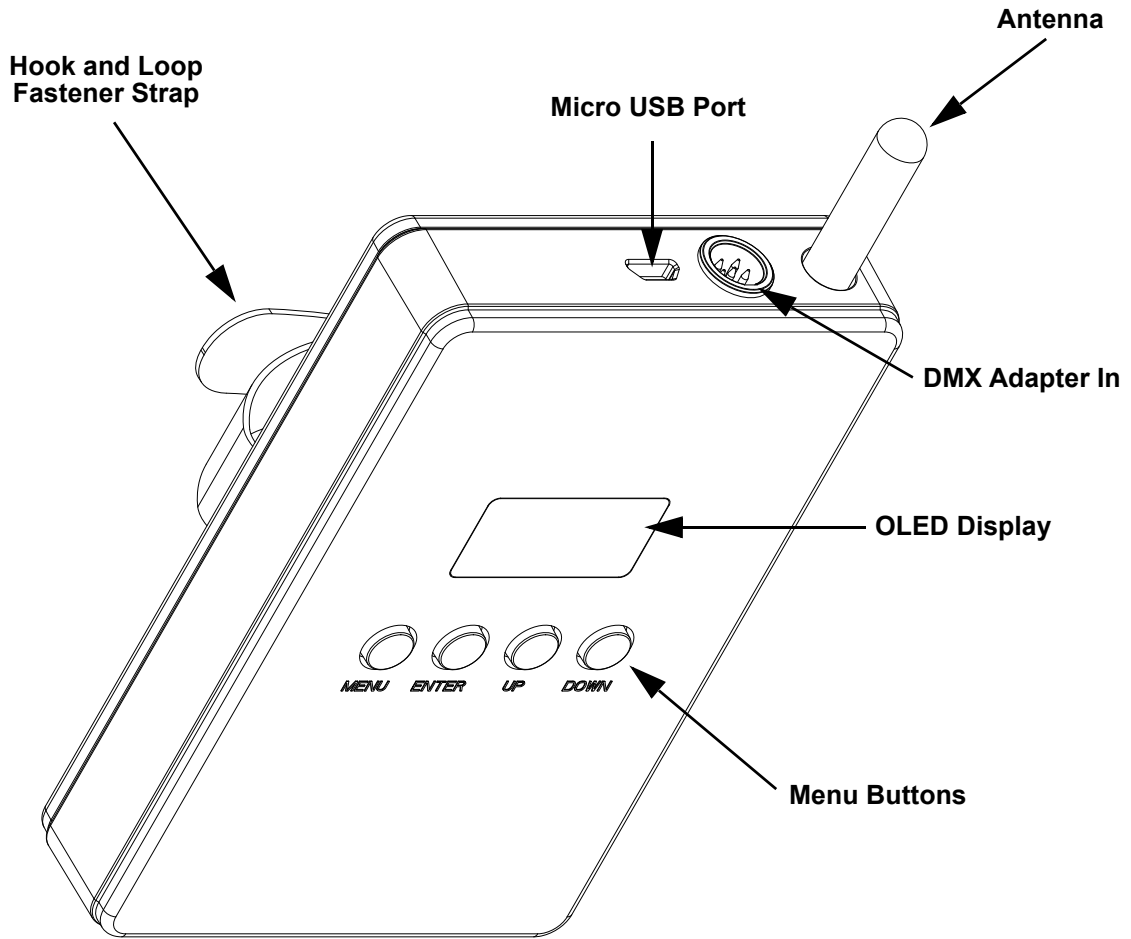

To power the product ON or OFF, press and hold the <MENU> + <ENTER> buttons for 3 seconds.

Product Dimensions

Front View

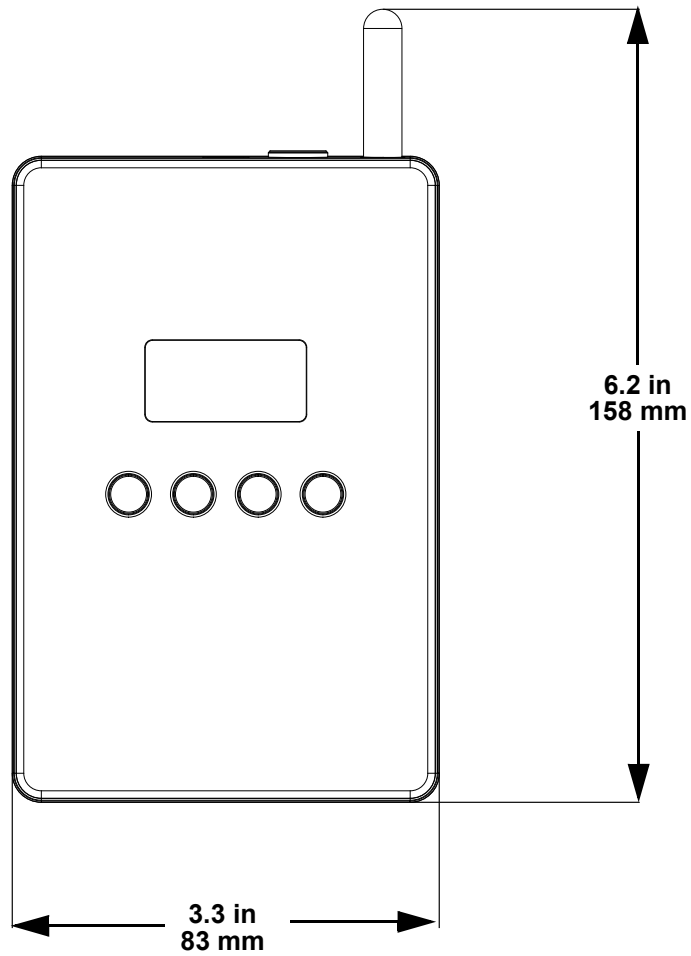

Side View

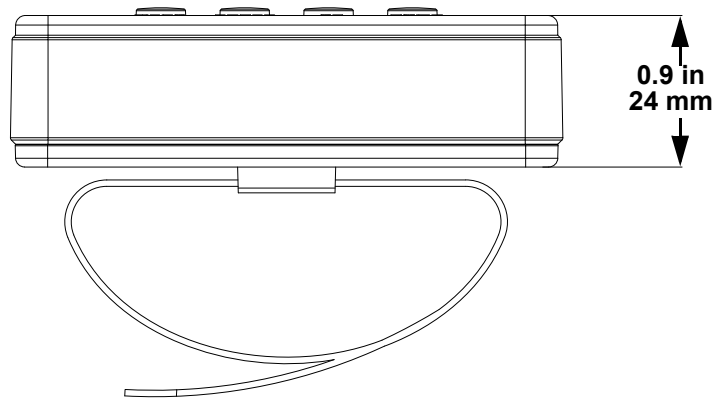

3. Setup

AC Power

The FlareCON Air 2 has an auto-ranging power supply and it can work with an input voltage range of 100 to 240 VAC, 50/60 Hz.

To determine the product's power requirements (circuit breaker, power outlet, and wiring), use the current value listed on the label affixed to the product's back panel, or refer to the product's specifications chart. The listed current rating indicates the product's average current draw under normal conditions.



- **Always connect the product to a protected circuit (a circuit breaker or fuse). Make sure the product has an appropriate electrical ground to avoid the risk of electrocution or fire.**
- **To eliminate unnecessary wear and improve its lifespan, during periods of non-use completely disconnect the product from power via breaker or by unplugging it.**



Never connect the product to a rheostat (variable resistor) or dimmer circuit, even if the rheostat or dimmer channel serves only as a 0 to 100% switch.

Battery Power

The FlareCON Air 2 comes with a rechargeable lithium battery for cable free operation.

Charging the Battery

The battery charges whenever the FlareCON Air 2 is plugged into the external charger and the charger is plugged into a power source. If the product is plugged in and not in operation, make sure the product is turned off.



When connected to the power supply, charge the FlareCON Air 2 while the unit is powered OFF.

Battery Life Indicator

The indicators on the OLED Menu Display show how much battery life remains available. The drawing below provides a key to reading the battery life indicators.

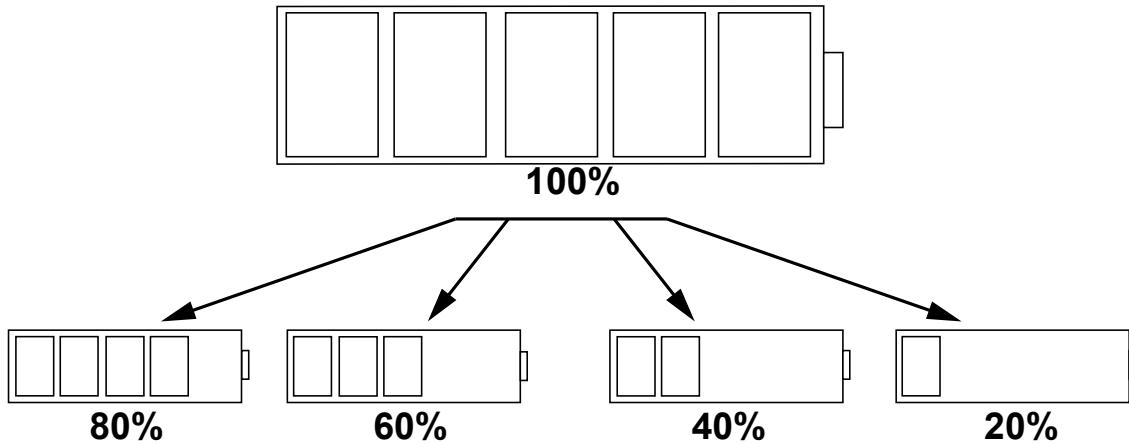

Battery Run Time

Maximum Run Time (all colors on)	Recharge Time
Up to 8 hours	4 hours

Mounting

Before mounting the product, read and follow the safety recommendations indicated in the [Safety Notes](#).

Orientation

The FlareCON Air 2 may be mounted in any position; however, make sure adequate ventilation is provided around the product.

Rigging

- Before deciding on a location, always make sure there is easy access to the product for maintenance and programming.
- Make sure adequate ventilation is provided around the product.
- Make sure that the structure or surface onto which you are mounting the product can support the product's weight. (see the [Technical Specifications](#))
- When mounting the product overhead, always use a safety cable. Mount the product securely to a rigging point, whether an elevated platform or a truss.
- When rigging the product onto a truss, use a mounting clamp of appropriate weight capacity.
- When power linking multiple products, mount the products close enough for power linking cables to reach.

Mounting Diagram

Safety Hook and Loop fastener

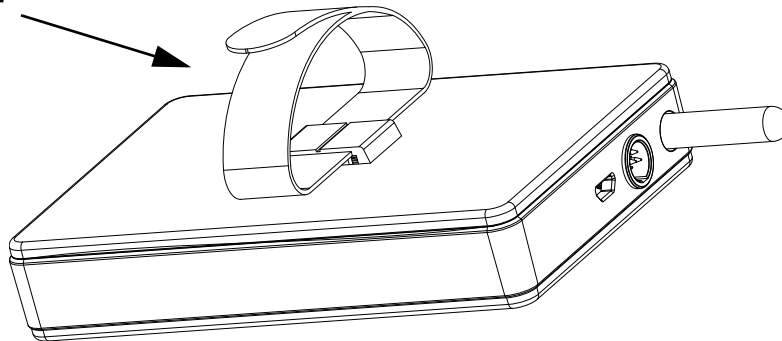

4. Operation

Control Panel Operation

To access the control panel functions, use the four buttons located underneath the display. Please refer to the [Product Overview](#) to see the button locations on the control panel.

Button	Function
<MENU>	Press to find an operation mode or to back out of the current menu option
<UP>	Press to scroll up the list of options or to increase the numeric value in a function
<DOWN>	Press to scroll down the list of options or to decrease the numeric value in a function
<ENTER>	Press to activate a menu option or set the selected value in a function

Menu Map

Mode	Programming Levels	Description
Manual Channel	<CH01–16>	Manually selects a channel for the D-Fi network
Input Mode	<WIFI>	Sets the input mode to wireless WiFi™ signal input
	<DMX>	Sets the input mode to wired DMX signal input
Back Light	On	Does not turn off
	10S	Turns off after 10 seconds
	20S	Turns off after 20 seconds
	30S	Turns off after 30 seconds
Information	Version	Shows the installed software version
	WIFI SSID <Wi-Fi™ name>	Displays the name of the current Wi-Fi™ network (SSID)
	WIFI Channel <01–16>	Displays the number of the current channel
Factory Reset	No	Resets to factory settings
	Yes	



To power the product ON or OFF, press and hold the <MENU> + <ENTER> buttons for 3 seconds.

Using FlareCON Air 2

FlareCON Air 2 works with the following:

- Smartphones and tablets (mobile devices) running the FlareCON app
- D-Fi-compatible lights
- D-Fi Hub
- DMX controllers
- DMX lights when used with a D-Fi Hub or connected directly via a DMX cable

The FlareCON app is free and available from the Google Play Store or the Apple App Store.



Be sure to connect only one mobile device at a time.

Wireless D-Fi Signals

When FlareCON Air 2 is used with a mobile device it creates a wireless network (Wi-Fi™) for receiving the signals from the mobile device, and then it sends D-Fi signals wirelessly to D-Fi-compatible lights or a D-Fi Hub.

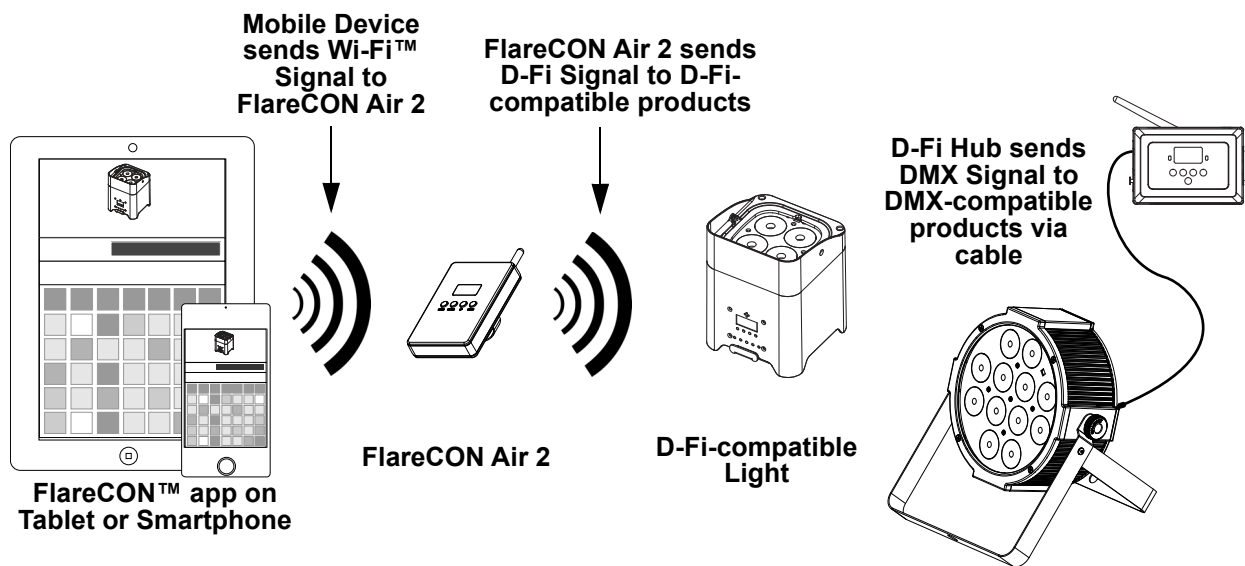

Be sure to connect only one smartphone or tablet at a time.



- The tablet or smartphone running FlareCON app should be within 200 ft (60 m) of FlareCON Air 2.
- Always install FlareCON Air 2 within 400 ft (120 m) of the products receiving D-Fi. FlareCON Air 2 works best within the line of sight of the D-Fi products.

DMX Signals from a Controller via Cable

When FlareCON Air 2 is used with a DMX controller, FlareCON Air 2 receives signals from the controller through a DMX cable. FlareCON Air 2 then sends:

- D-Fi signals wirelessly to D-Fi-compatible lights
- DMX signals via a DMX cable connected to any DMX-compatible product

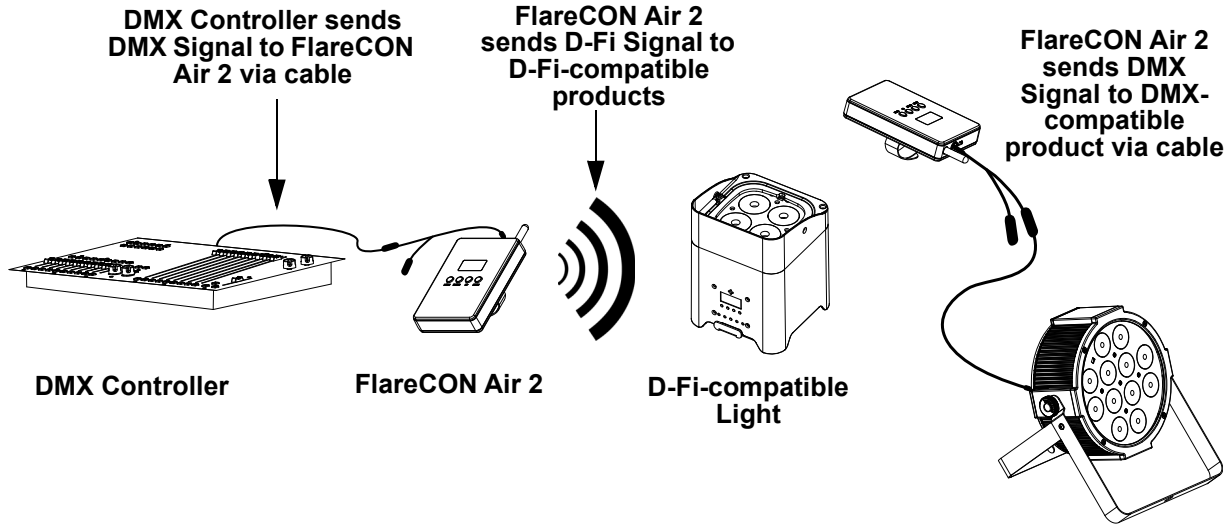

i Always install FlareCON Air 2 within 400 ft (120 m) of the products receiving D-Fi. FlareCON Air 2 works best within the line of sight of the D-Fi products.

Wireless Control with DMX Products

When using the FlareCON Air 2 to wirelessly send D-Fi signals while using DMX lights that have no D-Fi capability, FlareCON Air 2 must be used with a D-Fi Hub. The FlareCON Air 2 creates a wireless network (Wi-Fi™) for receiving the signals from the mobile device, and sends D-Fi signals wirelessly to the D-Fi Hub. D-Fi Hub then converts those signals to DMX and sends those signals through a DMX cable to the DMX lights.

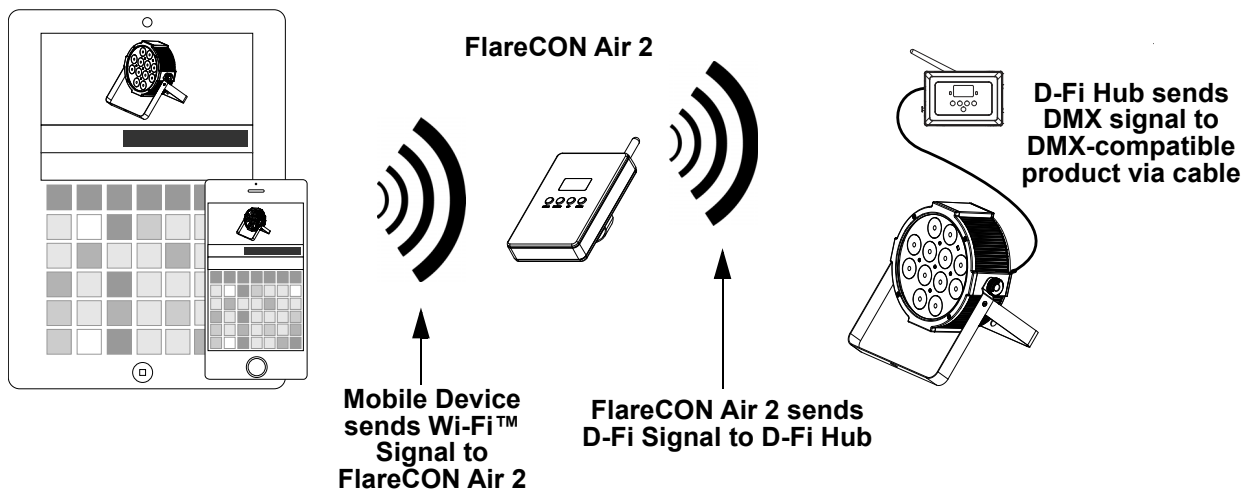

! Be sure to connect only one smartphone or tablet at a time.

- The tablet or smartphone running FlareCON app should be within 200 ft (60 m) of FlareCON Air 2.
- Always install FlareCON Air 2 within 400 ft (120 m) of the products receiving D-Fi. FlareCON Air 2 works best within the line of sight of the D-Fi products.

Setting Up Products with FlareCON Air 2

The FlareCON Air 2 allows several different configurations with D-Fi and DMX products. Refer to examples shown in the [Using FlareCON Air 2](#) sections for configuration requirements in your setup.

To configure your products with FlareCON Air 2, you will be performing the following steps:

1. Connect FlareCON Air 2 to power.
2. Turn on Wi-Fi™ on your mobile device.



If you have not already done so, download and install FlareCON app onto your mobile device.

3. Go to Wi-Fi™ settings on your mobile device and connect to FlareCON Air 2's default Wi-Fi™ (SSID). See [Connecting to a Mobile Device](#) for instructions.
4. To avoid interference with other wireless signals in the immediate area, manually select the Wi-Fi™ channel <CH01> to <CH16> on the FlareCON Air 2. See [Selecting A Channel](#).
5. Set your products to receive signal input from FlareCON Air 2. For details, refer to the User Manuals for the products in your setup.
 - Set products to receive signals on the same channel as was set on FlareCON Air 2 in the previous step.
 - Set products to their most basic DMX personality.



Make sure the DMX starting address is set to 001.

6. Select whether FlareCON Air 2 receives signals wirelessly or via a DMX cable. See [Selecting a Signal Input Mode](#).



For DMX products, be sure to use a DMX cable to connect from DMX Out of the product transmitting the DMX signal (depending on your setup, FlareCON Air 2 or D-Fi Hub) to the DMX In of the product receiving the DMX signal.

7. Once your products are properly connected to FlareCON Air 2, and FlareCON Air 2 is properly connected to FlareCON app, open the FlareCON app on your mobile device. For details, refer to the [Connecting to a Mobile Device](#) section.

Using your mobile device, you can now select the colors emitted by your lights. Refer to the [Configuring FlareCON Air 2](#) section below for details on setting up products with FlareCON Air 2.



For detailed information on the operation of the FlareCON app, download the User Manual from the Chauvet website at <http://www.chauvetdj.com/>.

Configuring FlareCON Air 2

Configuring FlareCON Air 2 involves selecting the operating channel and input mode - either Wi-Fi™ to operate it from a mobile device, or DMX to connect it to a controller.

Selecting A Channel

The Wi-Fi™ channel can be selected manually. To select an operating channel, do the following:

1. Connect FlareCON Air 2 to power.
2. Press <MENU> to access the main menu.
3. Use <UP> or <DOWN> until **Manual Channel** is selected in the display.
4. Press <ENTER>.
5. Use <UP> or <DOWN> to scroll through channel numbers <CH01> to <CH16>.
6. Press <ENTER> to select the channel number. Use this same channel to set the other products' receiving channel.

Selecting a Signal Input Mode

Selecting the signal mode input determines how the FlareCON Air 2 receives control signals, either in Wi-Fi™ mode from the FlareCON app or in DMX mode from a DMX controller or another light.

To set the signal input mode, do the following:

1. Connect the FlareCON Air 2 to power.
2. Press <MENU> to access the main menu.
3. Use <UP> or <DOWN> until **Input Mode** is selected in the display.
4. Press <ENTER>.
5. Use <UP> or <DOWN> to select the <WIFI> or <DMX> mode.
6. Press <ENTER> to set the desired input mode.

Connecting to a Mobile Device

Connect to a mobile device only after the FlareCON Air 2 has been configured, and the FlareCON app has been installed on the mobile device.

To complete the connection to your mobile devices, you will need to do the following:

1. Find the name of FlareCON Air 2's default Wi-Fi™. See [Finding the Name of FlareCON Air 2 Wi-Fi™](#).
2. Using the Wi-Fi™ network name identified in the previous step, select this Wi-Fi™ network on your mobile device. See [Connecting to FlareCON Air 2 Wi-Fi™](#).

When using a smartphone or tablet running on Android operating systems, it might be helpful to adjust the Wi-Fi™ settings on your mobile device to avoid losing the Wi-Fi™ connection to the FlareCON Air 2. Depending on the exact model of your mobile device, the exact wording in your settings options may vary. Perform either or both of the following:



1. **Open Wi-Fi™ settings on your smartphone or tablet.**
2. **Deselect functionality that turns on Wi-Fi™ scanning.**
3. **Deselect functionality that automatically switches Wi-Fi™ networks.**
4. **Return to Wi-Fi™ settings on your smartphone or tablet.**
5. **Select the Application Manager.**
6. **Select ALL.**
7. **Scroll to and select Wi-Fi™ to clear data and clear cache.**
8. **Scroll to and select Wi-Fi™ Direct Share to clear data and clear cache.**

For more information about the Wi-Fi™ settings options on your smartphone or tablet, see the documentation that came with your mobile device.



Chauvet recommends having lights configured and ready to respond before connecting a mobile device.

Finding the Name of FlareCON Air 2 Wi-Fi™

To find the name of the FlareCON Air 2 Wi-Fi™, do the following:

1. Connect FlareCON Air 2 to power.
2. Make sure a channel is selected (see [Selecting A Channel](#)) and the input mode is set to **WIFI** (see [Selecting a Signal Input Mode](#)).
3. Press **<MENU>** to access the main menu.
4. Use **<UP>** or **<DOWN>** until **Information** is selected in the display.
5. Press **<ENTER>**.
6. Use **<UP>** or **<DOWN>** to display the current Wi-Fi™ name and channel number. Use this default Wi-Fi™ name (SSID) from FlareCON Air 2 to select the Wi-Fi™ on your mobile devices.
7. Press **<MENU>** to exit the **Information** menu function.

Connecting to FlareCON Air 2 Wi-Fi™

To connect a mobile device to the FlareCON Air 2 Wi-Fi™, do the following:

1. Connect FlareCON Air 2 to power.
2. Make sure the input mode is set to **WIFI**.
3. To connect your mobile device to the FlareCON Air 2 Wi-Fi™, use the Settings function of the mobile device to select the Wi-Fi™ network named in FlareCON Air 2's Information screen.
4. Open the FlareCON app. The SSID displays in the center of the screen.



Once connected, the name of the FlareCON Air 2 default Wi-Fi™ can be changed in the FlareCON app. See the FlareCON User Manual for more information. User Manuals are available at <http://www.chauvetdj.com/>.

Connecting to a DMX Controller

To configure a system that uses a DMX controller connected to FlareCON Air 2 to control lights (see [DMX Signals from a Controller via Cable](#)), do the following:

1. Set FlareCON Air 2 for DMX input. See [Selecting a Signal Input Mode](#).
2. Connect a DMX cable from the DMX Out of the controller to the DMX In adapter of FlareCON Air 2.
3. Configure remaining products. See [Setting Up Products with FlareCON Air 2](#).

For information about operating the DMX controller, see the user Manual for the controller. User Manuals for CHAUVET controllers are available from the Chauvet website at <http://www.chauvetdj.com/>.

Controlling DMX Lights with D-Fi Hub

FlareCON Air 2 can wirelessly control DMX lights when it is used with a D-Fi Hub.

To configure a system that uses FlareCON Air 2 and a D-Fi Hub to wirelessly control DMX lights, do the following:

1. Configure products as instructed in [Setting Up Products with FlareCON Air 2](#) using a D-Fi Hub as one of the wirelessly receiving products.
2. Connect a DMX cable from the DMX Out of the D-Fi Hub to the DMX In of the DMX product.

Information about using D-Fi Hub can be found in its manual on the Chauvet website at <http://www.chauvetdj.com/>.

5. Maintenance

Product Maintenance

Dust build-up reduces light output performance and can cause overheating. This can lead to reduction of the light source's life and/or mechanical wear. To maintain optimum performance and minimize wear, clean your lighting products at least twice a month. However, be aware that usage and environmental conditions could be contributing factors to increase the cleaning frequency.

To clean the product, follow the instructions below:

1. Unplug the product from power.
2. Wait until the product is at room temperature.
3. Use a vacuum (or dry compressed air) and a soft brush to remove dust collected on the external surface/vents.
4. Clean all transparent surfaces with a mild soap solution, ammonia-free glass cleaner, or isopropyl alcohol.
5. Apply the solution directly to a soft, lint free cotton cloth or a lens cleaning tissue.
6. Softly drag any dirt or grime to the outside of the transparent surface.
7. Gently polish the transparent surfaces until they are free of haze and lint.



Always dry the transparent surfaces carefully after cleaning them.

6. Technical Specifications

Dimensions and Weight

Length	Width	Height	Weight
6.2 in (158 mm)	3.3 in (83 mm)	0.9 in (24 mm)	0.6 lb (0.3 kg)

Note: Dimensions in inches rounded to the nearest decimal digit.

Power

Power Supply Type	Range	Input Voltage
External	100 to 240 VAC, 50/60 Hz	5 VDC, 1.6 A
Parameter	120 V, 60 Hz	230 V, 50 Hz
Consumption	4 W	4 W
Operating Current	0.72 A	0.45 A

Wireless

Max Unobstructed Distance	Frequency Range
Wi-Fi™: 200 ft (60 m) D-Fi™: 400 ft (120 m)	2.412 to 2.484 GHz

Thermal

Maximum External Temperature	Cooling System
104 °F (40 °C)	Convection

DMX

Channel Range	I/O Connectors
512	3-XLR

Ordering

Product Name	Item Code	UPC Number
FLARECONAIR2	03081588	781462219369



Returns

In case you need to get support or return a product:

- If you are located in the US, contact Chauvet World Headquarters.
- If you are located in the UK or Ireland, contact Chauvet Europe Ltd.
- If you are located in Benelux, contact Chauvet Europe BVBA.
- If you are located in France, contact Chauvet France.
- If you are located in Germany, contact Chauvet Germany.
- If you are located in Mexico, contact Chauvet Mexico.
- If you are located in any other country, DO NOT contact Chauvet. Instead, contact your local distributor. See www.chauvetdj.com for distributors outside the U.S., UK, Ireland, Benelux, France, Germany, or Mexico.



If you are located outside the US, UK, Ireland, Benelux, France, Germany, or Mexico, contact your distributor of record and follow their instructions on how to return Chauvet products to them. Visit our website www.chauvetdj.com for contact details.

Call the corresponding Chauvet Technical Support office and request a Return Merchandise Authorization (RMA) number before shipping the product. Be prepared to provide the model number, serial number, and a brief description of the cause for the return.

To submit a service request online, go to www.chauvetdj.com/service-request.

Send the merchandise prepaid, in its original box, and with its original packing and accessories. Chauvet will not issue call tags.

Clearly label the package with the RMA number. Chauvet will refuse any product returned without an RMA number.



Write the RMA number on a properly affixed label. DO NOT write the RMA number directly on the box.

Before sending the product, clearly write the following information on a piece of paper and place it inside the box:

- Your name
- Your address
- Your phone number
- RMA number
- A brief description of the problem

Be sure to pack the product properly. Any shipping damage resulting from inadequate packaging will be your responsibility. FedEx packing or double-boxing are recommended.



Chauvet reserves the right to use its own discretion to repair or replace returned product(s).

Contact Us

General Information	Technical Support
Chauvet World Headquarters	
Address: 5200 NW 108th Ave. Sunrise, FL 33351 Voice: (954) 577-4455 Fax: (954) 929-5560 Toll Free: (800) 762-1084	Voice: (844) 393-7575 Fax: (954) 756-8015 Email: chauvetcs@chauvetlighting.com Website: www.chauvetdj.com
Chauvet Europe Ltd	
Address: Unit 1C Brookhill Road Industrial Estate Pinxton, Nottingham, UK NG16 6NT Voice: +44 (0) 1773 511115 Fax: +44 (0) 1773 511110	Email: UKtech@chauvetlighting.eu Website: www.chauvetdj.eu
Chauvet Europe BVBA	
Address: Stokstraat 18 9770 Kruishoutem Belgium Voice: +32 9 388 93 97	Email: BNLtech@chauvetlighting.eu Website: www.chauvetdj.eu
Chauvet France	
Address: 3, Rue Ampère 91380 Chilly-Mazarin France Voice: +33 1 78 85 33 59	Email: FRtech@chauvetlighting.fr Website: www.chauvetdj.eu
Chauvet Germany	
Address: Bruno-Bürgel-Str. 11 28759 Bremen Germany Voice: +49 421 62 60 20	Email: DEtech@chauvetlighting.de Website: www.chauvetdj.eu
Chauvet Mexico	
Address: Av. de las Partidas 34 - 3B (Entrance by Calle 2) Zona Industrial Lerma Lerma, Edo. de México, CP 52000 Voice: +52 (728) 690-2010	Email: servicio@chauvet.com.mx Website: www.chauvetdj.mx

Outside the US, U.K., Ireland, Benelux, France, Germany, or Mexico, contact the dealer of record. Follow the instructions to request support or to return a product. Visit our website for contact details.