

15NA100

8Ω**LF Drivers** - 15.0 Inches

- 1600 W continuous program power capacity
- 100 mm (4 in) aluminium voice coil
- 45 - 2000 Hz response
- 98 dB sensitivity
- FEA optimized Neodymium magnet assembly
- Double silicone spider with optimized compliance
- Ventilated voice coil gap for reduced power compression
- Aluminum demodulating rings allows a very low distortion figure

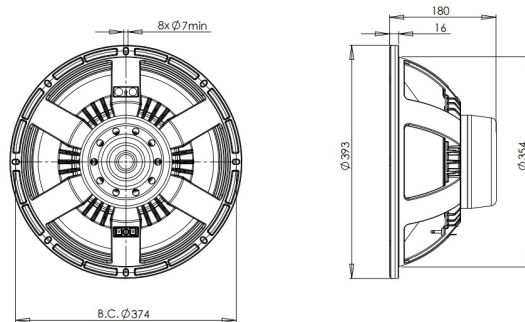

15NA100

LF Drivers- 15.0 Inches

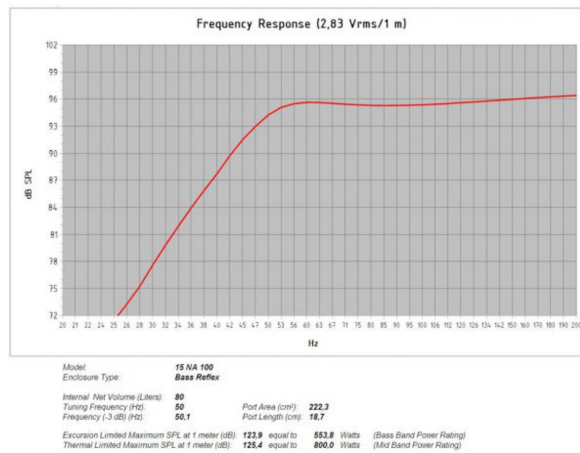
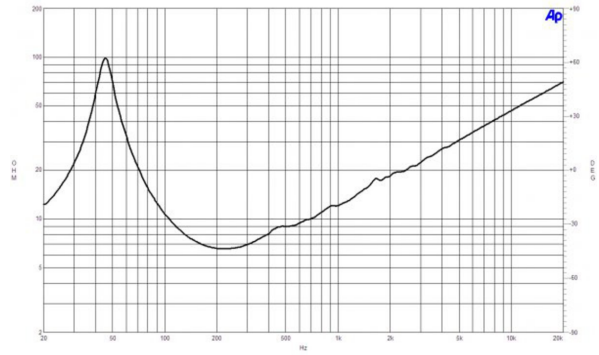
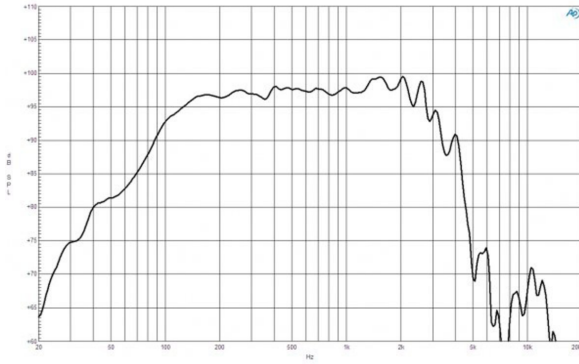

SPECIFICATIONS

Nominal Diameter	380 mm (15.0 in)
Nominal Impedance	8 Ω
Minimum Impedance	6.6 Ω
Nominal Power Handling ¹	800 W
Continuous power handling ²	1600 W
Sensitivity (1W/1m) ³	98.0 dB
Frequency Range	45 - 2000 Hz
Voice Coil Diameter	100 mm (4.0 in)
Winding Material	Aluminium
Former Material	Glass Fibre
Winding Depth	23.0 mm (0.9 in)
Magnetic Gap Depth	11.0 mm (0.43 in)
Flux Density	1.2 T

DESIGN

Surround Shape	Triple Roll
Cone Shape	Exponential
Magnet Material	Neodymium Inside Slug
Spider	Double Silicone
Pole Design	T-Pole
Woofer Cone Treatment	WP Waterproof Front Side
Recommended Enclosure	80.0 dm ³ (2.82 ft ³)
Recommended Tuning	50 Hz

PARAMETERS⁴

Resonance Frequency	47 Hz
Re	5.1 Ω
Qes	0.29
Qms	6.1
Qts	0.28
Vas	88.0 dm ³ (3.1 ft ³)
Sd	855.0 cm ² (132.5 in ²)
η _o	2.9 %
Xmax	± 10.0 mm
Xvar	± 9.0 mm
Mms	136.0 g
Bl	26.3 Txm
Le	1.2 mH
EBP	162 Hz

B&C Speakers s.p.a.

Via Poggiomoro, 1 - Loc. Vallina, 50012 Bagno a Ripoli (FI) - ITALY - Tel. +39 055 65721 - Fax +39 055 6572312 - mail@bcspeakers.com

MOUNTING AND SHIPPING INFO

Overall Diameter	393 mm (15.5 in)
Bolt Circle Diameter	374 mm (14.7 in)
Baffle Cutout Diameter	354.0 mm (13.9 in)
Depth	180 mm (7.09 in)
Flange and Gasket Thickness	16 mm (0.62 in)
Air Volume Occupied by Driver	6.0 dm ³ (0.21 ft ³)
Net Weight	9.3 kg (20.5 lb)
Shipping Units	1
Shipping Weight	10.6 kg (23.37 lb)
Shipping Box	425x425x224 mm (16.73x16.73x8.82 in)

SERVICE KIT

Recone kit	RCK15NA1008
------------	-------------

1. 2 hours test made with continuous pink noise signal within the range Fs-10Fs. Power calculated on rated minimum impedance. Loudspeaker in free air.
2. Power on Continuous Program is defined as 3 dB greater than the Nominal rating.
3. Applied RMS Voltage is set to 2.83 V for 8 ohms Nominal Impedance.
4. Thiele-Small parameters are measured after a high level 20 Hz sine wave preconditioning test.