

12FHX76

8Ω**Coaxials** - 12.0 Inches

- 700 W continuous program power capacity
- 60°x40° nominal coverage
- 45 - 18000 Hz response
- 98 dB sensitivity
- Modified exponential horn flare for improved acoustic loading and controlled coverage
- 33 mm (1.3") HF unit exit diameter
- Single Ferrite magnet assembly
- Aluminium demodulating ring allows a very low distortion figure

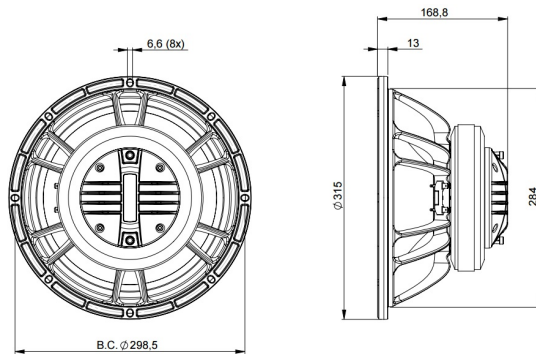

12FHX76

Coaxials- 12.0 Inches

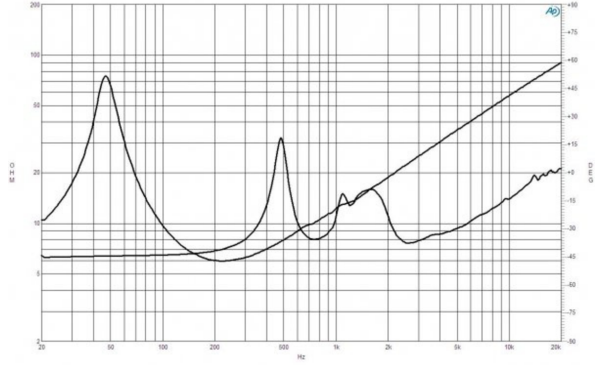
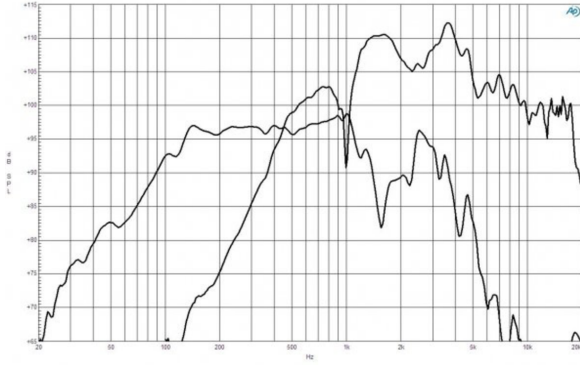

12FHX76 HF horizontal directivity map

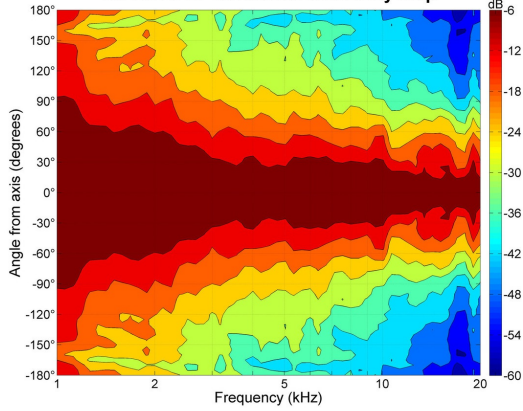

12FHX76 HF vertical directivity map

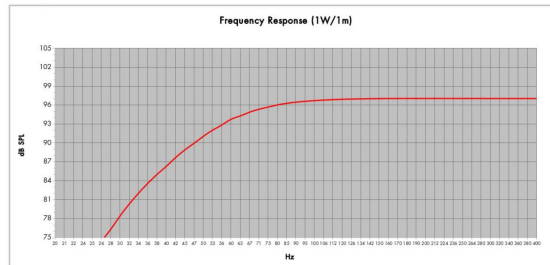
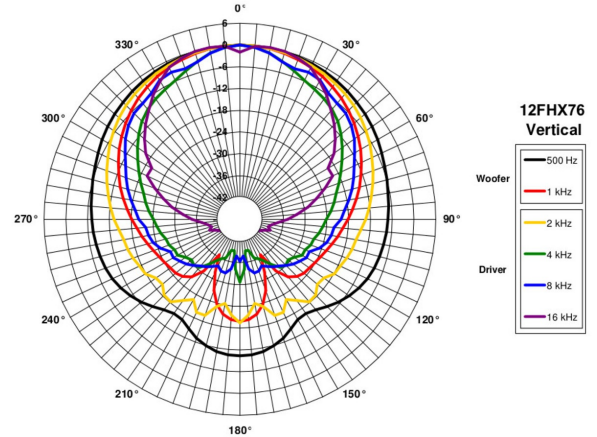
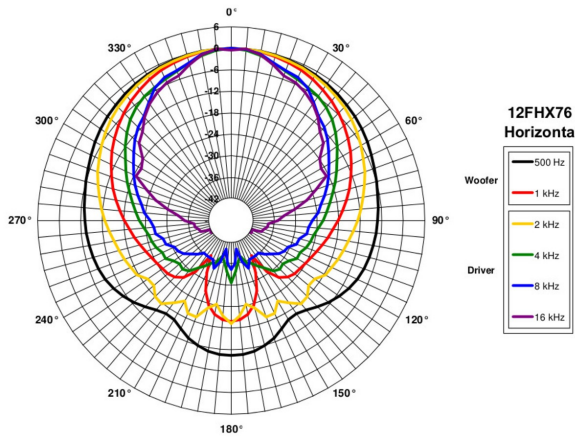
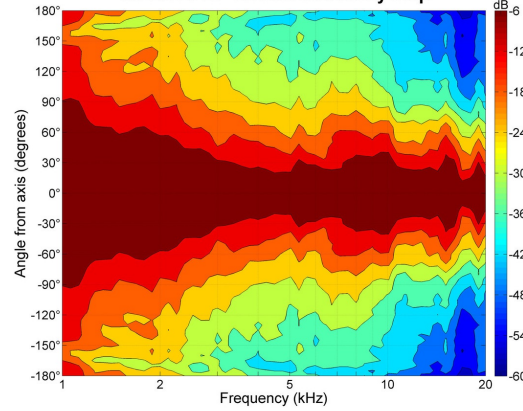

Model:	12FHX76	Configuration:	One Driver
Enclosure Type:	Size Reflex		
Internal Net Volume [lms]:	50	Q _{ts} :	7
Tuning Frequency [Hz]:	50	Port Area [cm ²]:	138,7
Frequency [-3 dB] [Hz]:	61,5	Port Length [cm]:	21,8

SPECIFICATIONS

Nominal Diameter	320 mm (12.0 in)
Nominal Impedance	8 Ω
Minimum Impedance LF	6.0 Ω
Minimum Impedance HF	7.8 Ω
Frequency Range	45 - 18000 Hz
Dispersion Angle ¹	60°x40 °
Woofer Cone Treatment	WP Waterproof Front Side
Magnet Material	Ferrite

PARAMETERS

Resonance Frequency	48 Hz
Re	5.2 Ω
Qes	0.36
Qms	5.4
Qts	0.33
Vas	88.0 dm ³ (3.1 ft ³)
Sd	522.0 cm ² (80.9 in ²)
η _o	2.7 %
X _{max}	± 6.5 mm
X _{var}	± 4.0 mm
M _{ms}	47.0 g
Bl	14.4 Txm
Le	1.6 mH
EBP	133 Hz

SPECIFICATIONS LF UNIT

LF Sensitivity ²	98.0 dB
LF Nominal Power Handling ³	350 W
LF Continuous Power Handling ⁴	700 W
LF Voice Coil Diameter	76 mm (3.0 in)
LF Winding Material	Copper
LF Flux Density	1.0 T
Former Material	Glass Fibre
Winding Depth	16.5 mm (0.65 in)
Magnetic Gap Depth	8.0 mm (0.31 in)

MOUNTING AND SHIPPING INFO

Overall Diameter	315 mm (12.4 in)
Bolt Circle Diameter	298 mm (11.7 in)
Baffle Cutout Diameter	284 mm (11.14 in)
Depth	169 mm (6.65 in)
Flange and Gasket Thickness	13 mm (0.51 in)
Net Weight	8.4 kg (18.52 lb)
Shipping Units	1
Shipping Weight	9.7 kg (21.38 lb)
Shipping Box	425x425x224 mm (16.73x16.73x8.82 in)

SPECIFICATIONS HF UNIT

HF Sensitivity ⁵	106.0 dB
HF Nominal Power Handling ⁶	80 W
HF Continuous Power Handling ⁷	160 W
HF Voice Coil Diameter	75 mm (3.0 in)
HF Winding Material	Aluminium
HF Flux Density	1.6 T
Diaphragm Material	Titanium
Recommended Crossover ⁸	1.2 kHz
Inductance	0.14 mH

SERVICE KIT

LF recone kit	RCK12FHx768
MF replacement diaphragm	MMD3BTN8M

1. Included by -6 dB down points.
2. Applied RMS Voltage is set to 2.83V.
3. 2 hours test made with continuous pink noise signal within the range Fs-10Fs. Power calculated on rated minimum impedance. Loudspeaker in free air.
4. Power on Continuous Program is defined as 3 dB greater than the Nominal rating.
5. Applied RMS Voltage is set to 2.83V.
6. 2 hour test made with continuous pink noise signal within the range from the recommended crossover frequency to 20 kHz. Power calculated on rated minimum impedance. Loudspeaker in free air.
7. Power on Continuous Program is defined as 3 dB greater than the Nominal rating.
8. 12 dB/oct. or higher slope high-pass filter.