



A9910020 Play-XV RF Receiver 4x4A 4-channel constant voltage PWM-dimmer

Designed for Home installation, Hotels, Theater, Shops where LED RGB color-changing is required

- Controlled by wireless RF Wall-mount or Hand-remote Controller
- Each Receiver is addressable to 8 zones
- Possibility to save 6-8 static, mixing colors or RGB-chase modes
- Separate control function for channel-4 (white)

Technical Specifications:

Input/Output Power: 12V-36V DC

Max. total load: 4x4A

4x 48W@12V

4x 96W@24V

4x 144W@36V

RF Operation Frequency: 868Mhz

Range: +/-15 mtr

Ta: -20° - +50°

Tc: +75°

Dimension L x W x H (mm): 178 x 58 x 21

Weight: 0.04 Kg

Protection: IP-20 Class II

Approvals: CE / FCC / RoHS

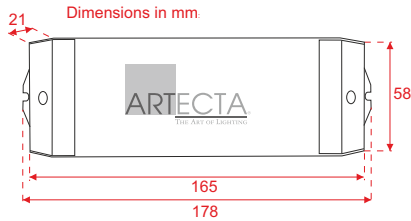

A A9990365 (order separately)

Control by wireless RF Wall mounted 4-channel RGB(W) touch control synchronously with wireless hand-remote

- 4 color-scenes
- 10 built-in RGB color-effects
- white LED's separate dimmable

Dimensions: L x W x H (mm): 86 x 86 x 10 mm

Weight: 0.13 Kg

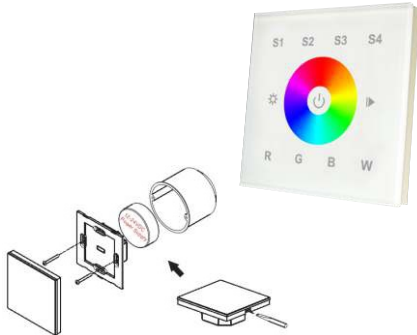

Can be mounted on Euro-Wallbox U-30/50

B A9990370 (order separately)

Control by RGB RF wireless hand-remote control synchronously control with wireless wall-panel

- control up to 6 zones with 6 scenes at each zone
- preset 10 changing modes
- enable to dim or mix colour

Dimension L x W x H (mm): 140 x 86 x 29.1 mm

Weight: 0.09 Kg



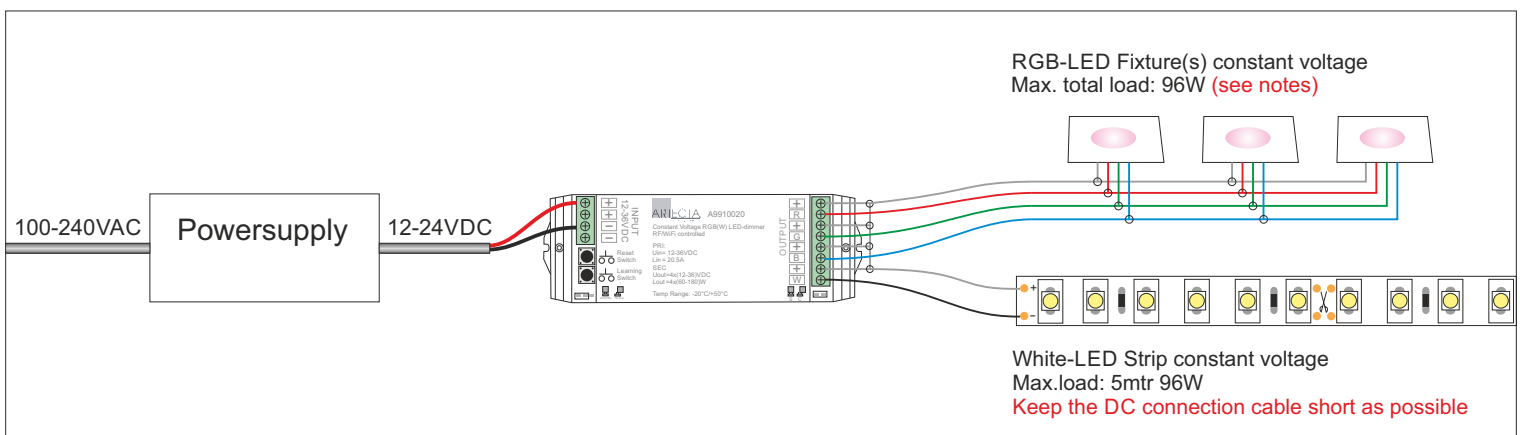
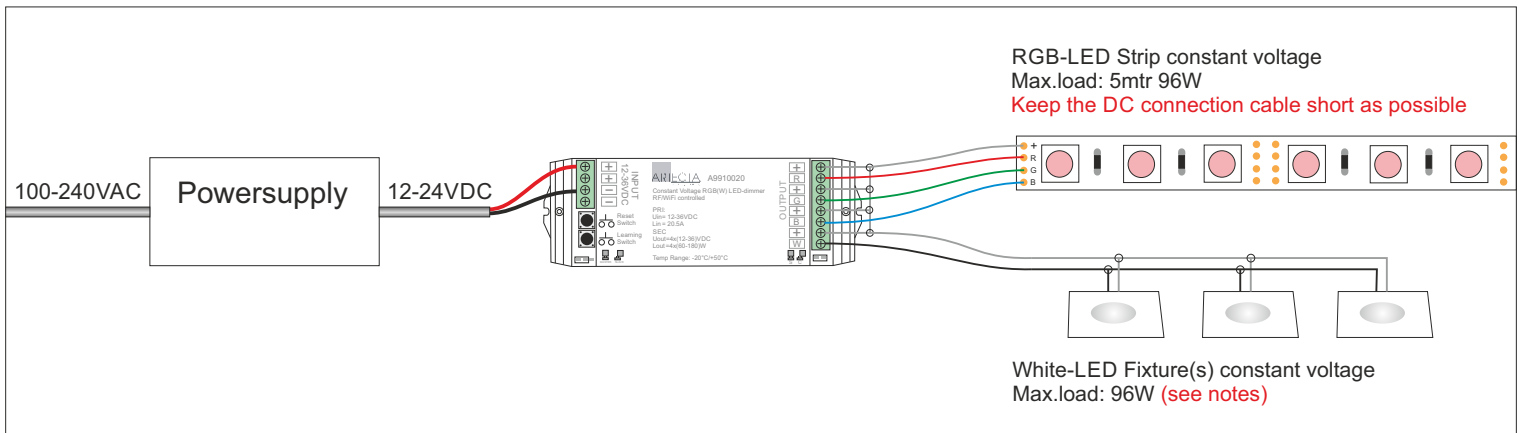
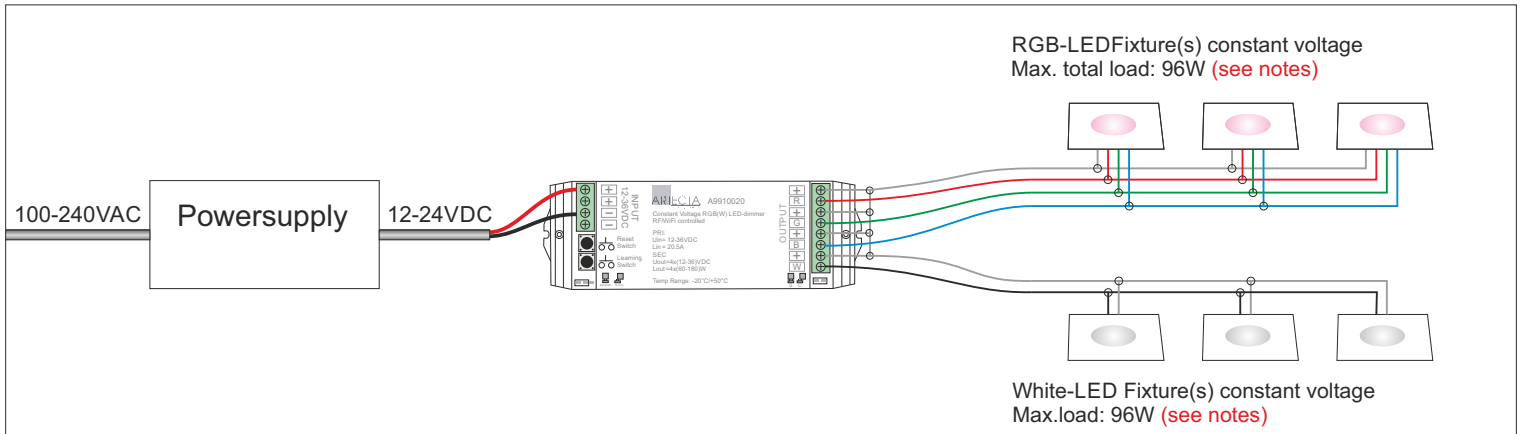
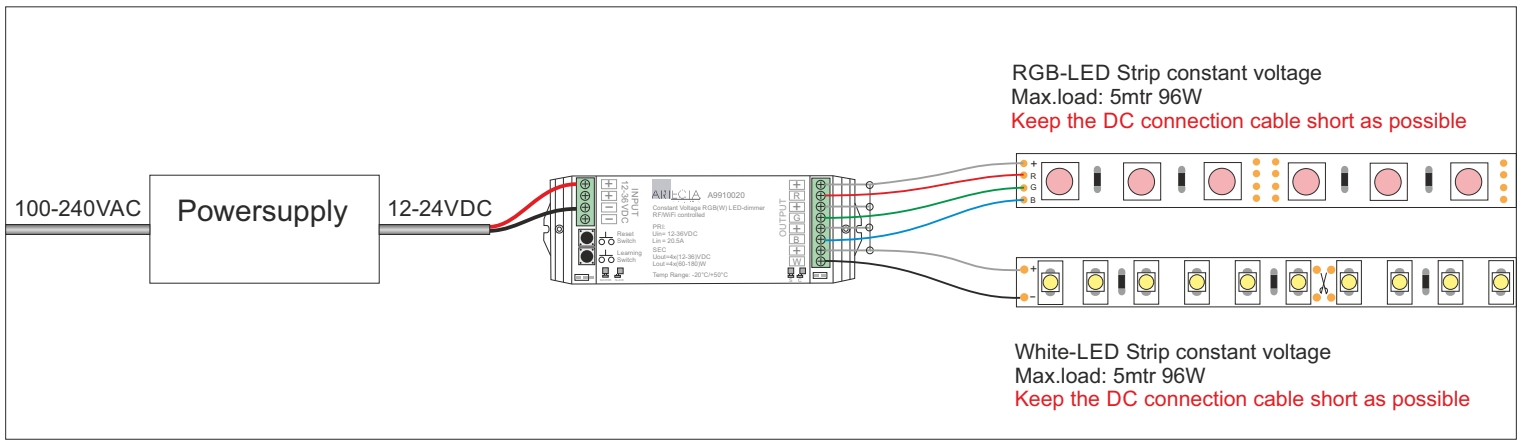

Notes:

UK
The thickness of the 24V DC cable depends on the total cable length and total power consumption of all connected fixtures. (See page 3)

D
Der Durchmesser des 24V DC-Kabels hängt von der Gesamtlänge des Kabels und der gesamten Leistungsaufnahme aller angeschlossenen Geräte ab. (Siehe Seite 5)

ES
La sección del cable de 24V DC depende de la longitud total del cable y el consumo de energía total de todas las luminarias (véase la página 7)

NL
De diameter van de 24V DC-kabel is afhankelijk van de totale lengte van de kabel en het totale stroomverbruik van alle verbonden toestellen. (zie tabel op pagina 4)

FR
Le diamètre du câble d'alimentation 24V DC dépend de la longueur totale du câble et la consommation électrique totale de tous les périphériques connectés. (voir page 6)

IT
Il diametro del cavo 24V DC dipende dalla lunghezza totale del cavo e il consumo di energia totale di tutti apparecchi collegati

Recommended cable conductor surface (mm²) with cable lengths of 1-50 meters. for parallel connected 24 volt LED fixtures.

Note; This table is an obligation and not a binding opinion. If necessary, make a electrical resistance calculation ($Pouillet A \times R = p \times l$)

24 Volt		Cable inner conductor 1.5mm ²					Cable inner conductor 2.5mm ²					Cable inner conductor 4mm ²				
		Watt	24	48	72	96	120	144	168	192	216	240	264	288	312	336
Kabel- lengte (m)	Ampere	1	2	3	4	5	6	7	8	9	10	11	12	13	14	15
	1															
2																
3																
4																
5																
6																
7																
8																
9																
10																
11																
12																
13																
14																
15																
16																
17																
18																
19																
20																
21																
22																
23																
24																
25																
26																
27																
28																
29																
30																
31																
32																
33																
34																
35																
36																
37																
38																
39																
40																
41																
42																
43																
44																
45																
46																
47																
48																
49																
50																

- As much as possible shortest path for the 24V cables
- Branching cables without interrupting the main cable
- Transformer must be placed in centre of the connected fixtures
- Polarity: positive (+) = red or brown, minus (-) = black or blue
- Transformer-capacity 25% greater than the sum of conected fixtures

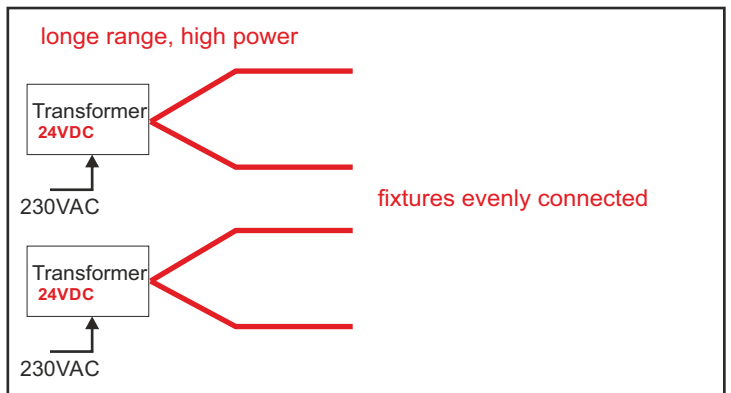
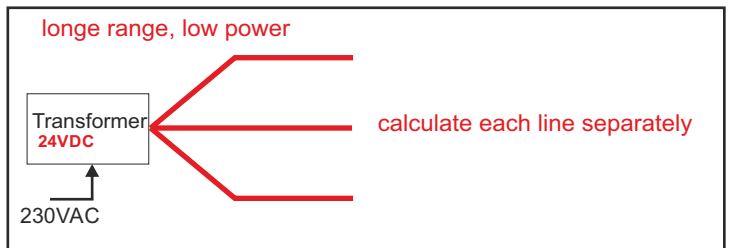
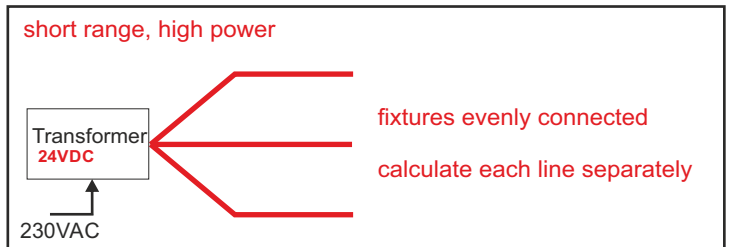
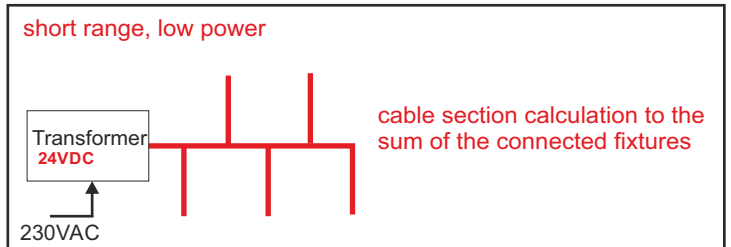

Geadviseerd kabelgeleider-oppervlak (mm²) bij kabellengtes van 1-50 mtr. voor 24 Volt parallel aangesloten LED armaturen.

Note; Deze tabel is een vrijblijvend en geen dwingend advies. Maak indien nodig een berekening van elektrische weerstand en geleidbaarheid met de wet van Pouillet ($A \times R = p \times l$)

24 Volt	Kabelgeleider 1.5mm ²					Kabelgeleider 2.5mm ²					Kabelgeleider 4mm ²				
	Watt	24	48	72	96	120	144	168	192	216	240	264	288	312	336
Kabel-lengte (m) \ Ampere	1	2	3	4	5	6	7	8	9	10	11	12	13	14	15
1															
2															
3															
4															
5															
6															
7															
8															
9															
10															
11															
12															
13															
14															
15															
16															
17															
18															
19															
20															
21															
22															
23															
24															
25															
26															
27															
28															
29															
30															
31															
32															
33															
34															
35															
36															
37															
38															
39															
40															
41															
42															
43															
44															
45															
46															
47															
48															
49															
50															

- Zoveel mogelijk kortste weg voor de 24V kabels
- Kabels aftakken zonder de hoofdkabel te onderbreken
- Trafo mogelijk in het midden plaatsen
- Polariteit: plus(+) = rood of bruin, min(-) = zwart of blauw
- Trafo-capaciteit 25% hoger kiezen dan de som der belastingen

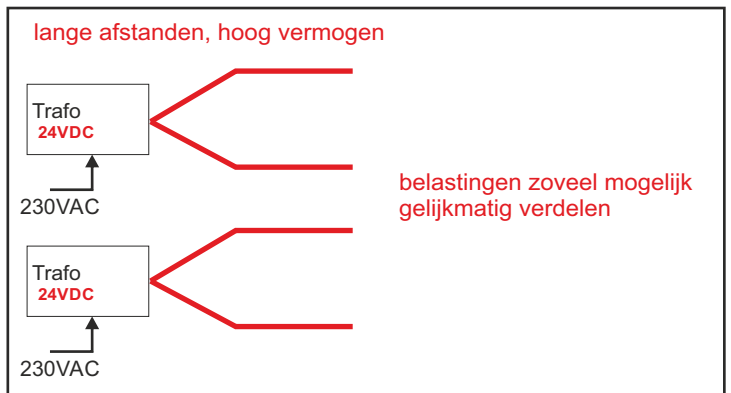
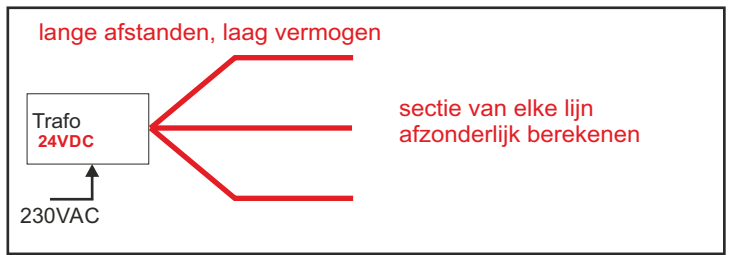
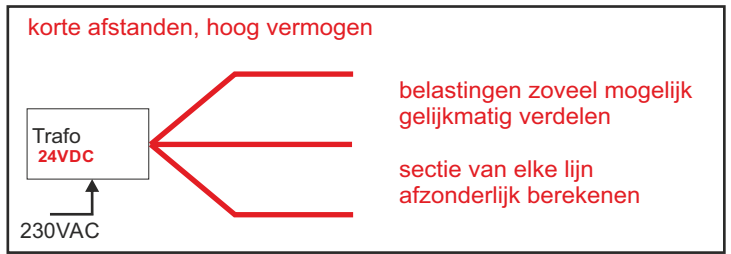
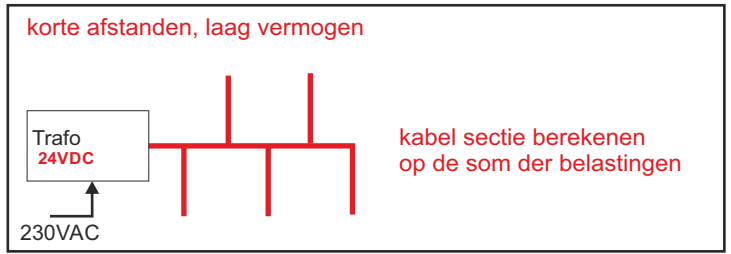

Empfohlener Querschnitt vom Kabelinnenleiter in mm² bei Kabellängen von 1-50 Meter für parallel geschaltete 24-Volt-LED-Leuchten.

Bitte beachten: Diese Tabelle ist eine unverbindliche Beratung. Falls erforderlich, eine Berechnung vom elektrischen Widerstand und Leitfähigkeit mit der Formel von Pouillet machen

24 Volt		Kabelinnenleiter 1.5mm ²					Kabelinnenleiter 2.5mm ²					Kabelinnenleiter 4mm ²				
		24	48	72	96	120	144	168	192	216	240	264	288	312	336	360
Kabel- länge (m)	Ampere	1	2	3	4	5	6	7	8	9	10	11	12	13	14	15
	1															
2																
3																
4																
5																
6																
7																
8																
9																
10																
11																
12																
13																
14																
15																
16																
17																
18																
19																
20																
21																
22																
23																
24																
25																
26																
27																
28																
29																
30																
31																
32																
33																
34																
35																
36																
37																
38																
39																
40																
41																
42																
43																
44																
45																
46																
47																
48																
49																
50																

- So viel wie möglich dem kürzesten Weg für die 24V-Leitungen
- Kabel abzweigen ohne Unterbrechung der Hauptleitung
- Trafo wenn möglich in der Mitte montieren
- Polarität: positiv(+) = rot oder braun, minus(-) = schwarz oder blau
- Trafo-Kapazität immer 25% größer wählen als die Summe der Last

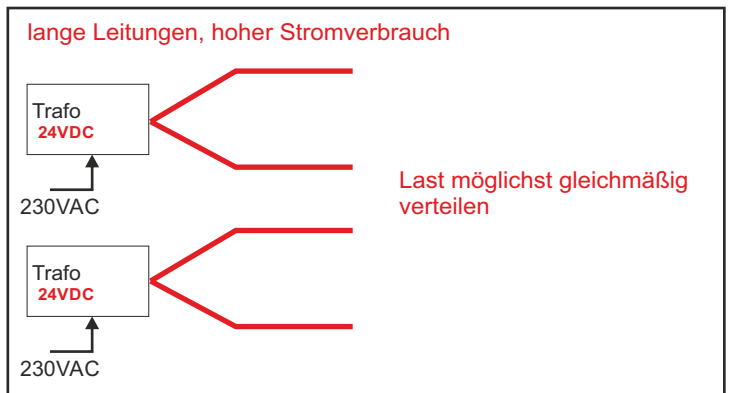
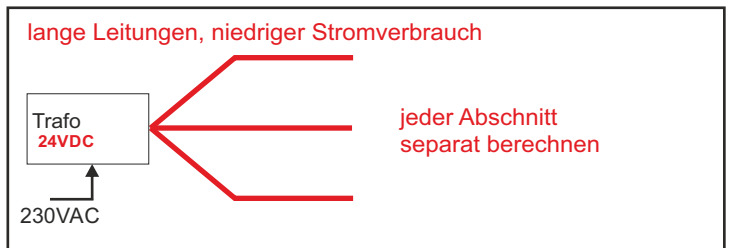
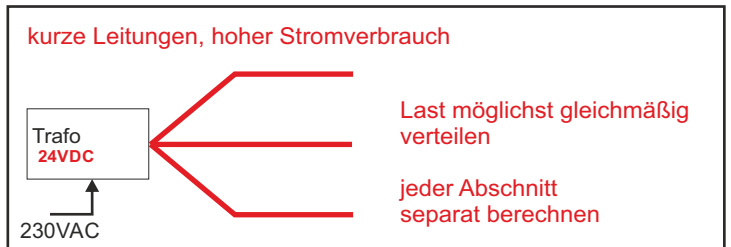
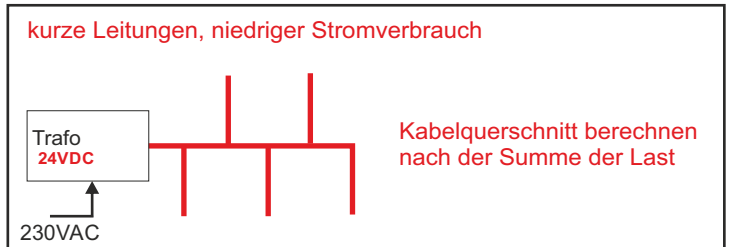

Surface recommandée conducteur de câble (mm²) 1-50 m longueurs de câble. connectés en parallèle pour 24 volts luminaires à LED.

Remarque, Ce tableau est un des conseils informels et non contraignants. Si nécessaire, un calcul de résistance électrique et la conductivité avec la loi de Pouillet ($A \times R = p \times l$)

24 Volts		Conducteur de câble 1.5mm ²					Conducteur de câble 2.5mm ²					Conducteur de câble 4mm ²				
		24	48	72	96	120	144	168	192	216	240	264	288	312	336	360
Kabel- länge (m)	Ampere	1	2	3	4	5	6	7	8	9	10	11	12	13	14	15
	1															
2																
3																
4																
5																
6																
7																
8																
9																
10																
11																
12																
13																
14																
15																
16																
17																
18																
19																
20																
21																
22																
23																
24																
25																
26																
27																
28																
29																
30																
31																
32																
33																
34																
35																
36																
37																
38																
39																
40																
41																
42																
43																
44																
45																
46																
47																
48																
49																
50																

Choisir le chemin le plus court pour les câbles 24V

Éclaircie câbles sans interrompre le câble principal

Transformateur peut être centrée

Polarité: positive (+) = rouge ou brun, moins (-) = noir ou bleu

Transformateur-capacité de 25% de plus que de choisir la charge

LED-lampes Parallèlement interrupteur

courte portée, de faible puissance

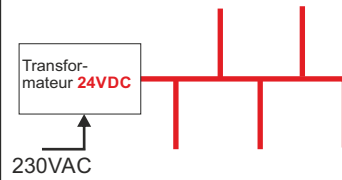

Calcul de la section de câble la somme des luminaires connectés

courtes distances, de forte puissance

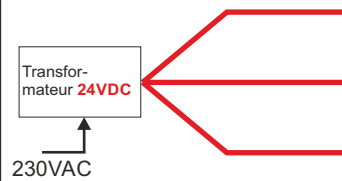

luminaires raccordés possible uniformément
section de chaque ligne calculer séparément

Les longues distances, de faible puissance

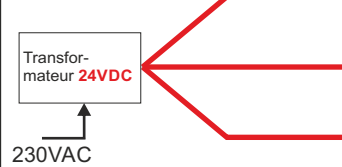

section de chaque ligne calculer séparément

Les longues distances, de forte puissance

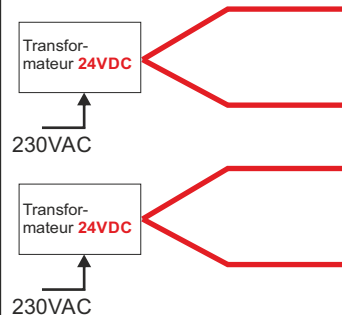

luminaires raccordés possible uniformément

Sección de cable recomendada en mm² con longitudes de cable 1-50 metros. para conectar en paralelo de 24 voltios LED fixtures.

Note; Este cuadro es un consejo informal y no vinculante. Si es necesario, un cálculo de resistencia eléctrica y la conductividad con la ley de Pouillet ($A \times R = p \times l$)

24 Voltios	Sección de cable 1.5mm ²					Sección de cable 2.5mm ²					Sección de cable 4mm ²					
	Watt	24	48	72	96	120	144	168	192	216	240	264	288	312	336	360
Kabel- lengte (m)	Ampere	1	2	3	4	5	6	7	8	9	10	11	12	13	14	15
1																
2																
3																
4																
5																
6																
7																
8																
9																
10																
11																
12																
13																
14																
15																
16																
17																
18																
19																
20																
21																
22																
23																
24																
25																
26																
27																
28																
29																
30																
31																
32																
33																
34																
35																
36																
37																
38																
39																
40																
41																
42																
43																
44																
45																
46																
47																
48																
49																
50																

Intente utilizar la mínima distancia de cable en líneas de 24V.

Intente utilizar una línea principal sin cortarlo y sacar de él derivaciones individuales

Si es posible coloque la fuente de alimentación en el centro de la línea [principal de distribución]

Polaridad: positivo (+) = rojo o marrón, negativo (-) = negro o azul

La fuente de alimentación debe ser 25% mayor que la suma de las luminarias a conectar

distancias cortas, de baja potencia

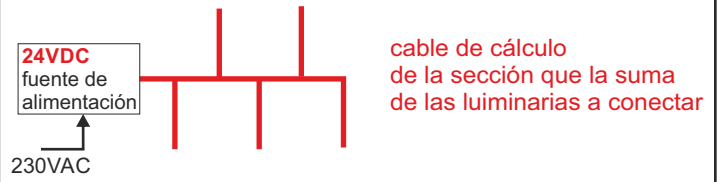

distancias cortas, de alta potencia

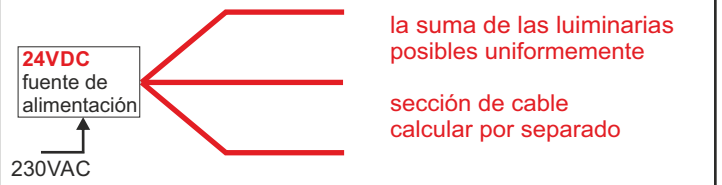

distancias largas, de baja potencia

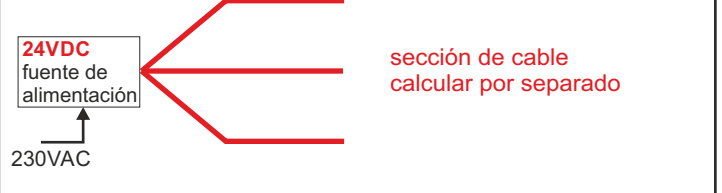

distancias largas, de alta potencia

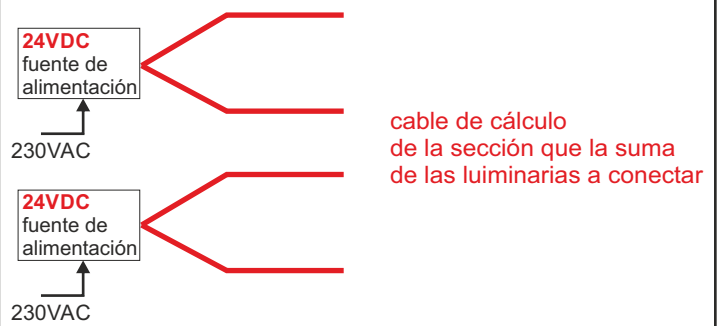

Sezione (mm²) raccomandata dei cavi con lunghezza da 1m a 50m per apparecchiature LED a 24V collegate in parallelo.

Nota: questa tabella indica valori tassativi, non solo suggerimenti.

Se necessario, sviluppare un calcolo di resistenza elettrica ($Pouillet A \times R = p \times l$)

24 Volt	Condotore interno del cavo 1.5mm ²					Condotore interno del cavo 2.5mm ²					Condotore interno del cavo 4mm ²					
	Watt	24	48	72	96	120	144	168	192	216	240	264	288	312	336	360
Lunghezza del cavo \ Ampere		1	2	3	4	5	6	7	8	9	10	11	12	13	14	15
1																
2																
3																
4																
5																
6																
7																
8																
9																
10																
11																
12																
13																
14																
15																
16																
17																
18																
19																
20																
21																
22																
23																
24																
25																
26																
27																
28																
29																
30																
31																
32																
33																
34																
35																
36																
37																
38																
39																
40																
41																
42																
43																
44																
45																
46																
47																
48																
49																
50																

Lunghezza più breve possibile per cavi 24V

Derivare i cavi senza interrompere il cavo principale

Collocare il trasformatore al centro delle apparecchiature collegate

Polarità: positivo (+) = rosso o marrone, negativo (-) = nero o blu

Trasformatore di potenza almeno superiore al 25% della somma delle potenze delle apparecchiature collegate

