

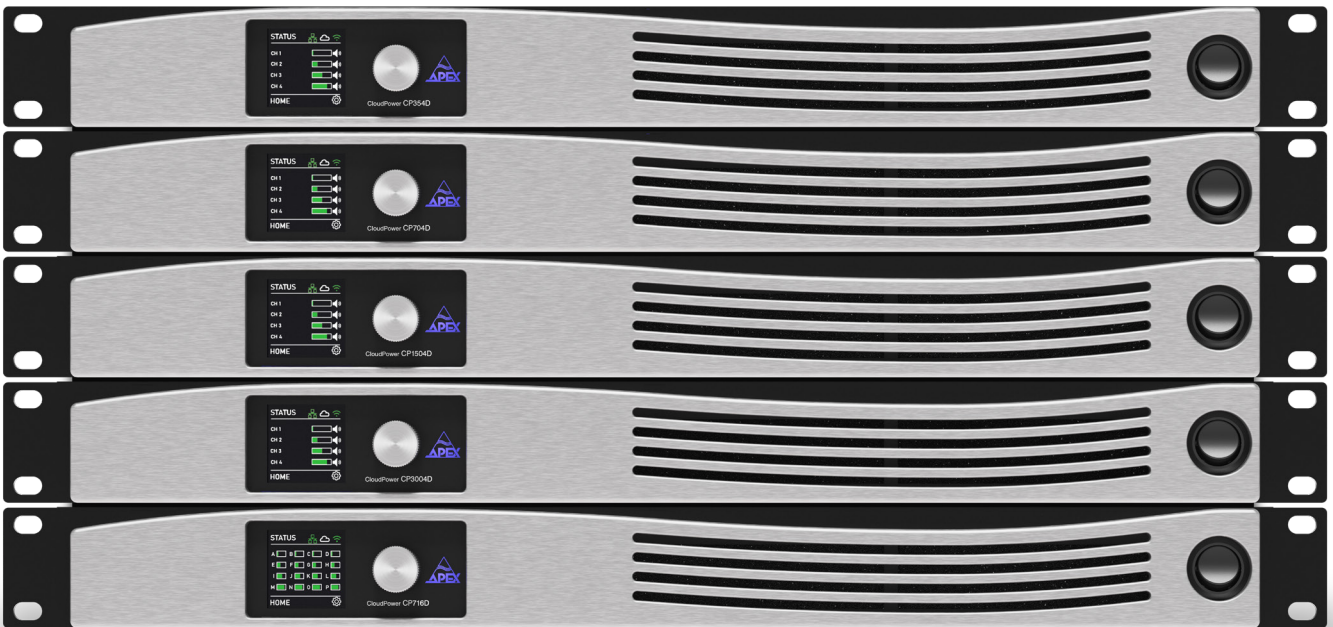

CloudPower™ Series

REMOTE CONTROLLABLE CLASS-D INSTALLATION AMPLIFIERS

Operation Manual V2



CP354

CP354D

CP704

CP704D

CP1504

CP1504D

CP3004

CP3004D

CP716D

CloudPower™ Series

REMOTE CONTROLLABLE CLASS-D INSTALLATION AMPLIFIERS

Operation Manual V2

Firmware version 1.3

For any support related questions please contact: info@apex-audio.be
Keep this manual and a record of the product serial number for future reference.

This document has been put together with as much care as possible.
The information within is complete and correct on the date of publication. However, updates on the specifications, functionality or software may have occurred since publication. To obtain the latest version of both manual and software, please visit <https://www.apex-audio.be/downloads>



Serial number of this product

Important Safety Instructions

CAUTION: to reduce the risk of electric shock, do not remove cover (or back). No user-serviceable parts inside. Refer servicing to qualified service personnel.



The lightning flash with arrowhead symbol, within an equilateral triangle, is intended to alert the user to the presence of an uninsulated "dangerous voltage" within the product's enclosure that may be of sufficient magnitude to constitute a risk of electric shock to persons.



The exclamation mark within an equilateral triangle is intended to alert the user to the presence of important operating and maintenance (servicing) instructions in the literature accompanying the equipment.

Instructions

Before installing or operating the equipment, read all safety instructions, warnings and operating instructions. Heed all warnings. Follow all instructions. Keep all safety, installation and operating instructions for future reference.

Installing and Operation Location

Do not use this apparatus near water. Do not expose this apparatus to drips or splashes. Do not place any objects filled with liquids, such as vases, on the apparatus.

Do not install near any heat sources such as radiators, heat registers, stoves, or other apparatus (including amplifiers) that produce heat. No naked flames, such as lighted candles, should be placed on the apparatus.

Do not install the apparatus in a confined space such as a book case or similar unit. Do not block any ventilation openings.

Ensure that foreign objects and liquids cannot get into the equipment.

Install in accordance with the manufacturer's instructions. Only use attachments/accessories specified by the manufacturer.

Use only with the cart, stand, tripod, bracket or table specified by the manufacturer, or sold with the apparatus. When a cart is used, use caution when moving the cart/apparatus combination to avoid injury from tip-over.



The apparatus should be located close enough to the AC outlet so that you can easily grasp the power cord plug at any time.

The mains plug, the appliance coupler or the mains switch is used as the disconnect device. Either device shall remain readily operable when the apparatus is installed or used.

Power Source and Grounding

This product should be operated only from the power source indicated on the apparatus or in the operating instructions. If you are not sure of the type of power supply to the premises where the equipment is to be used, consult your product dealer or local power company.

Do not defeat the safety purpose of the polarised or grounding-type plug. A polarised plug has two blades with one wider than the other. A grounding type plug has two blades and a third grounding prong. The wide blade or the third prong is provided for your safety. If the provided plug does not fit into your outlet, consult an electrician for replacement of the obsolete outlet.

Connect Class I construction apparatus to an AC outlet with a protective grounding connection.

Do not overload wall outlets, extension cords or integral convenience receptacles, as this can result in a risk of fire or electric shock.

Protect the power cord from being walked on or pinched, particularly at plugs, convenience receptacles and the point where they exit from the apparatus.

Unplug this apparatus during lightning storms or when unused for long periods of time.

Power supply class I grounding requirements:

For protection from fault currents, the equipment shall be connected to a grounding terminal. Plug the system power cord into an AC outlet that provides a ground connection. Substitute cords may not provide adequate fault protection. Only use the power cord supplied with this product or an authorized/equivalent replacement.

Safety notices:

Denmark:
Apparatets stikprop skal tilsluttes en stikkontakt med jord, som giver forbindelse til stikproppens jord.

Finland:
Laite on liitettävä suojakoskettimilla varustettuun pistoraasiaan.

Norway:
Apparatet må tilkoples jordet stikkontakt.

Sweden:
Apparaten skall anslutas till jordat uttag

Cleaning, Maintenance and Servicing

Unplug the apparatus from the wall outlet before cleaning. Do not use liquid cleaners or aerosol cleaners. Use a damp cloth for cleaning.

Do not attempt to service this product yourself, as opening or removing covers may expose you to dangerous voltage or other hazards. Refer all servicing to qualified service personnel.

Servicing is required when the apparatus has been damaged in any way, such as power-supply cord or plug damaged, liquid has been spilled or objects have fallen into the apparatus, the apparatus has been exposed to rain or moisture, does not operate normally or has been dropped.

Intended Use

The equipment may only be used for the purpose described in the operation instructions. Never carry out any work on the equipment other than as specified in the operating manual.

Never push objects of any kind into this product through openings, as they may touch dangerous voltage points or short-cut parts, which could result in a fire or electric shock.

Children should never use the apparatus without close adult supervision.

WARNING: Excessive sound pressure levels can cause hearing loss.

Environmental Precaution

Electrical and electronic equipment may contain hazardous substances for humans and their environment.



The "crossed out whee bin" symbol present on the device and represented above is there to remind one of the obligation of selective collection of waste. This label is applied to various products to indicate that the product is not to be thrown away as unsorted municipal waste. At the end of life, dispose of this product by returning it to the point of sale or to your local municipal collection point for recycling of electric and electronic devices.

Customer participation is important to minimize the potential effects on the environment and human health that can result from hazardous substances that may be contained in this product.

Please, dispose of this product and its packaging in accordance with local and national disposal regulations including those governing the recovery and recycling of waste electrical and electronic equipment. Contact

your local waste administration, waste collection company or dealer.



Table of Contents

Important Safety Instructions	3
Table of Contents	6
Introduction	7
Product Highlights	8
APEX CloudPower Series	9
Before You Get Started	10
Front Panel	11
Rear Panel	12
Processing & Signal Flow	14
Processing Details	16
Output Operation 70/100V	16
Presets	16
Operation Interfaces	17
Front Panel Operation	18
Homepage	19
Settings	20
Audio Menu	20
Mixer Matrix	21
Gain	21
Delay	22
PEQ	22
X-Over	23
Limiter	24
Signal Generator	24
Presets	25
Hotspot	26
Cloud	26
Network	27
About	27
Notes on Networking	28
IntelliCloud Web Interface	30
Accessing the Web UI	31
Login	32
USER Homepage	33
Mixer Matrix	35
Gain	36
Delay	37
PEQ	38
X-Over	41
Limiter	42
Speaker Preset	44

IntelliCloud Web Interface	
Sidebar Menu Network Devices	45
GROUPS	46
Edit Groups	47
Assign Groups	48
Gain	49
Delay	49
PEQ	50
Settings Menu	51
Device Name	51
Global Preset Library	52
Output Mode (70/100V, Bridge)	53
Network Settings	54
Hotspot	54
Cloud Connect	55
Login Credentials	55
Streaming Services	56
Spotify	56
Apple AirPlay	57
Firmware Update	58
About	59
Speaker Preset Creator	59
Speaker Preset Library	60
OEM Configuration	61
Application Examples	62
Specifications	64
Warranty	70

Dear Customer,

Thank you for choosing the Apex CloudPower™ for your sound reinforcement needs. The innovative CloudPower™ series is a professional amplifier solution equipped with integrated DSP features and secure remote control capabilities via the cloud.

With APEX IntelliCloud, you can conveniently manage your amplifiers remotely from your office environment. This not only streamlines your operations but also allows you to monitor performance and make adjustments without the necessity of on-site visits, resulting in valuable time and cost savings.

Foreword

The APEX CloudPower™ Series professional amplifiers feature built-in DSP and secure remote control over the cloud. Easily connect the amplifier to the WebUI on any HTML5 capable browser (MAC, PC, IOS, Android) with the built-in WiFi hotspot, or to a local area network via cat5 cable. The unique internal streaming source option makes it possible to playback Spotify and Apple AirPlay sources straight from your mobile device without the need for external hardware.

Multiple amplifiers can be controlled through the same webUI using the trusted and comprehensive workflow of our IntelliCloud software. Featuring high-end studio-grade analogue circuit designs, the APEX CloudPower™ Series sets a new benchmark in powered system management and speaker processing design. The proprietary Class-D amplifier control loop features GlidePath technology and exceptionally low intermodulation figures, resulting in wide stereo imaging.

CloudPower™ is founded on our proprietary GlidePath architecture, with DSP and amplifier circuits fully integrated for outstanding performance. GlidePath employs DC coupling throughout the signal path, dramatically reducing the time offsets and distortion associated with AC coupling. The result: crisper, punchier bass and brighter, more natural high frequencies, delivering superb intelligibility and higher perceived volume. CloudPower models with power ratings ranging from 350W to 3000W per channel fit all applications from small commercial spaces to the largest theatre.

Whether the application is a standalone system amplifier, or a comprehensive networked system with multiple amplifiers, the APEX CloudPower™ Series is designed to provide the solution that our clients demand. With comprehensive loudspeaker preset capability, implementing CloudPower™ into your system couldn't be easier.

Spotify and Spotify logos are trademarks of the Spotify Group. Dante and Dante logos are trademark of Audinate Group LTD. Apple, the Apple logo, AirPlay, iPad, iPhone, iPod, iPod Nano, iPod Touch, iTunes, Mac, and OS X are trademarks of Apple Inc.

Product Highlights

- Class D, DC coupled amplifiers
- All models can directly drive low impedance or 70/100V loudspeakers
- Intuitive IntelliCloud web interface
- Remote management from anywhere in the world
- Built-in Wi-Fi Hotspot for access without network connectivity
- Internal streaming source supporting Spotify and Apple Airplay
- Four analog balanced line inputs
- Dante™ audio network integrated in 'D' models
- 3 stages of on board 64bit DSP:
 - User processing DSP facilities:**
 - Gain, mute and phase inversion
 - Delay, up to 250ms (combined with group delay)
 - X-over HPF and LPF with 19 filter variations
 - 12-band parametric filtering, with choice of 16 filter types including all-pass filters
 - RMS and Peak limiter
 - Speaker processing DSP facilities:**
 - Delay up to 30ms
 - 12-band parametric filtering, with choice of 16 filter types including all-pass filters
 - X-over HPF and LPF with 19 filter variations
 - FIR filter implementation
 - RMS and Peak limiter
 - Group processing DSP facilities:**
 - 6 output groups, assignable between multiple amplifiers in the network
 - Group delay, up to 250ms (combined with user delay)
 - Group gain, mute and phase inversion
 - Additional 12-band parametric EQ per group
- Internal Global Preset and Speaker Preset library
- Apex GlidePath technology - our proprietary control loop provides a load independent frequency response and low harmonic and intermodulation distortion
- Power supply with worldwide operation from 100-240 Vac. Active power factor correction circuitry ensures efficient use of the mains power system
- Low idle loss (heat) through the use of a proprietary control loop which relaxes the output stages' dead time
- Daylight viewable colour OLED display
- Slimline 1U chassis

APEX CloudPower™ Series

CP354 4 x 350W

CP354D 4 x 350W with 4x4 Dante™

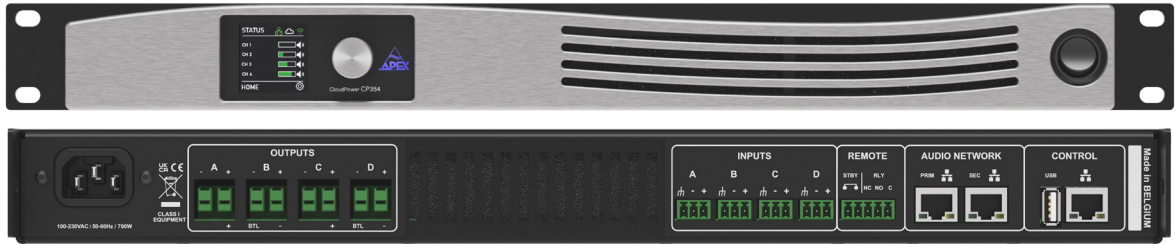

CP704 4 x 700W

CP704D 4 x 700W with 4x4 Dante™

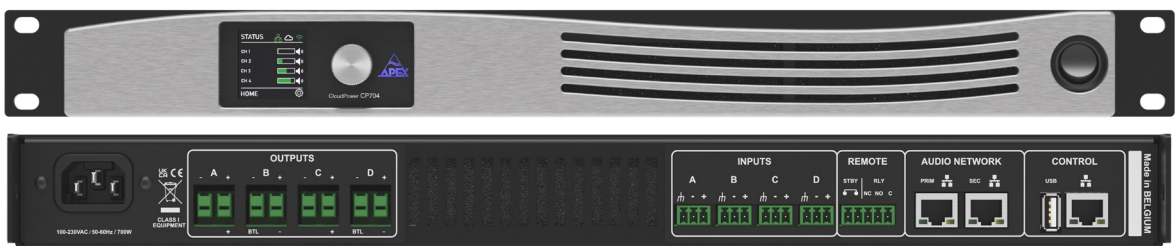

CP1504 4 x 1500W

CP1504D 4 x 1500W with 4x4 Dante™

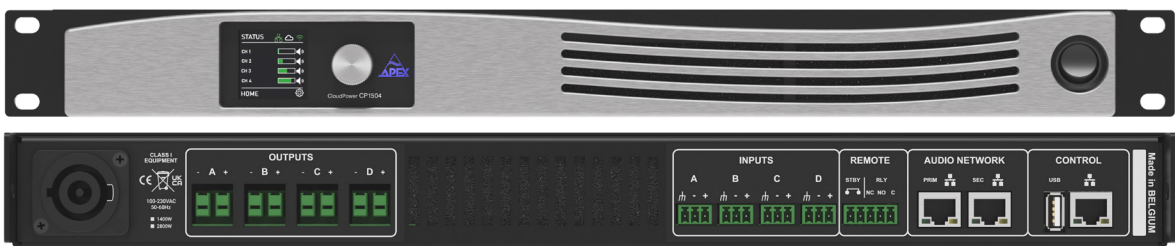

CP3004 4 x 3000W

CP3004D 4 x 3000W with 4x4 Dante™

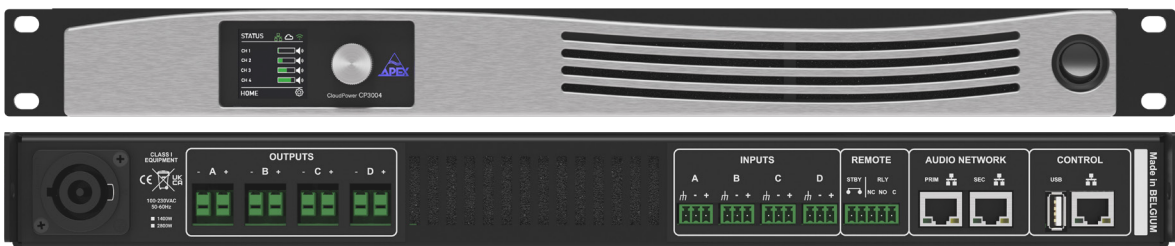

CP716D 16 x 700W with 16x16 Dante™

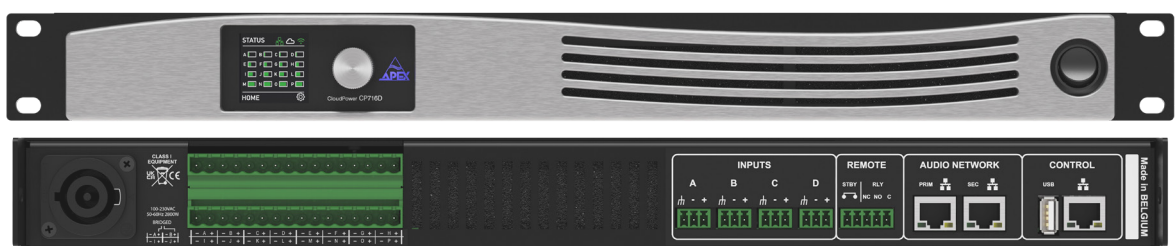

Before You Get Started

About this Manual

Carefully read all instructions and warnings before operating this device. Keep this manual in a safe place so that it can be referred to when required.

The latest manual revision can be downloaded from the download section of the Apex website:

<http://www.apex-audio.be/downloads>

This manual describes use of the CloudPower™ series

Inspection and Unpacking

This appliance has been carefully packed in the factory and the packaging was designed to withstand rough handling. Should the unit appear to have been damaged in transit, do not discard any of the packing material and notify the carrier immediately as they will be responsible.

Save all the packing materials for future use if you ever need to ship the unit again.

Please check the list below against the contents of the packaging. If any items are missing or damaged, contact the Apex dealer or distributor where you purchased the unit.

- Apex CloudPower™ amplifier
- AC power cable Europe
- Network cable, "straight" type

Operating Environment

The CloudPower™ is designed to operate in most normal climates, at a temperature between 0 °C and 50 °C (32 - 122 °F), with relative humidity between 10% and 60%.

The Apex CloudPower™ incorporates internal fan-cooling, which should keep the unit within its operating temperature. However, should the unit be installed in an equipment rack it is important to ensure that the temperature inside the rack does not exceed the upper limit. Under such circumstances, additional rack-mounted cooling fans may be necessary.

Do not block any ventilation openings.

Fit solid blanks (not ventilation blanks) to unused rack spaces to ensure effective air circulation.

Leaving gaps in between items of equipment degrades the effectiveness of forced-air cooling.

Power Requirements

Before you connect any unit to the mains, please make sure that the voltage of your local AC supply is within the acceptable range of the unit.

The Apex CloudPower™ is designed to work from an AC supply between 100 V and 240 V, at a frequency between 50 and 60 Hz. No AC voltage selector is provided as the device automatically adjusts to the incoming AC voltage.

Precautions should be taken so that the appliance is properly grounded at all times. This unit must be earthed.

Installation

If the unit is brought into a warm room from a cold environment, internal condensation may occur. Ensure that the unit has been allowed to reach ambient temperature before switching it on. We recommend one hour.

Although this unit is intended for installation in a standard 19-inch rack it can nevertheless be used free standing. If the unit is installed in a flight-case or in an equipment rack, fix the unit with all four screws through the front panel holes and the four screws from the back panel. For normal use no extra support is needed, but in more extreme conditions, such as on the road, we recommend the unit is supported at the rear.

Front Panel



The front panel features a modern and intuitive design, with a daylight-viewable color OLED display, a single rotary encoder for front-panel operation, a physical power switch and ventilation vents. All incorporated within a compact 1U 19" rack frame, ensuring both functionality and space efficiency.

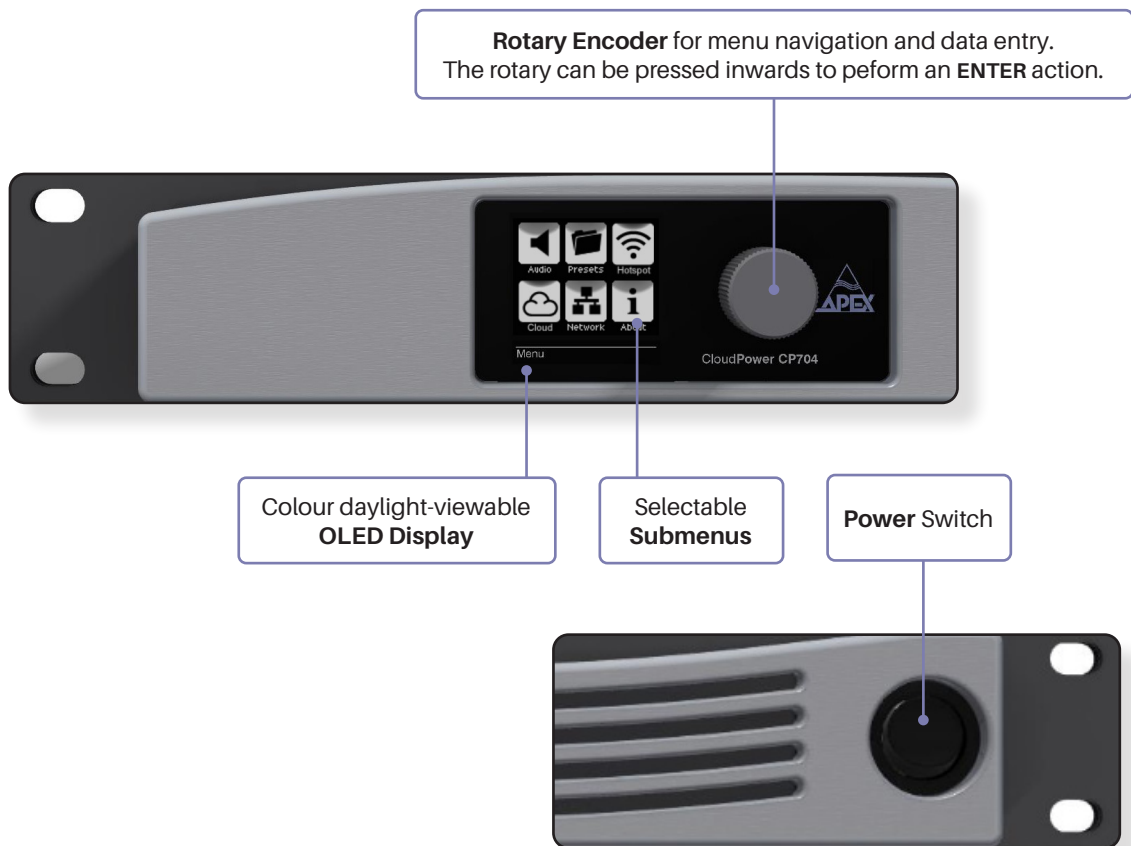

Rear Panel

CP354D - 4 channel

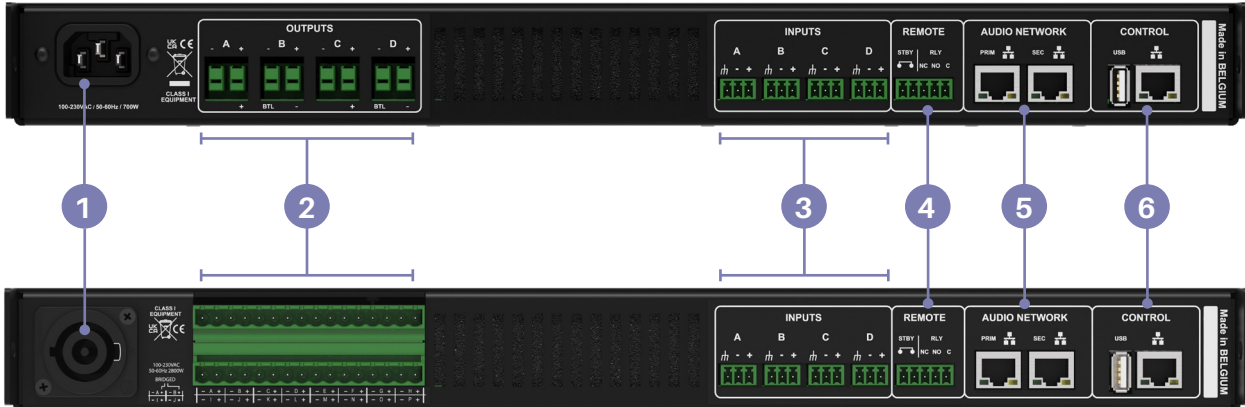

CP716D - 16 channel

- 1 IEC connectors accept worldwide operation from 100-240Vac. CloudPower™ must be grounded (earthed) with the safety ground pin to the mains distribution system. Never disconnect the earth (ground) pin on the mains cable (AC power cord).
- 2 Amplifier output connectors are sturdy terminal block connectors. Channels are located from left to right. Each channel has a marked hot (+) and cold (-) terminal.

- 3 Balanced analog line inputs are available on terminal block connectors with clearly marked hot (+), cold (-) and ground terminals. The use of twin-and-screen cable is recommended. In order to link inputs, physical splits can be made directly on the terminal block connectors. The input impedance is 20k Ohms.

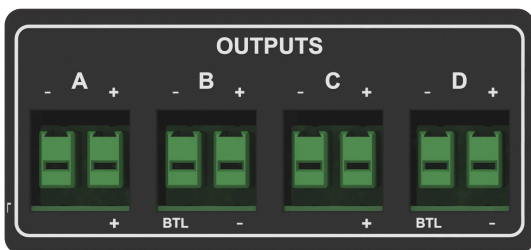

4 channel models

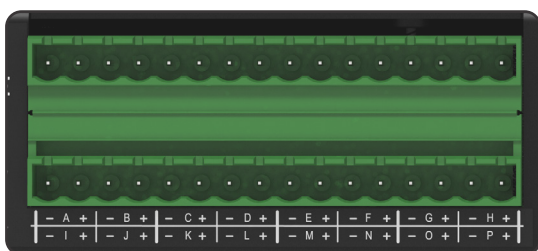

16 channel CP716D

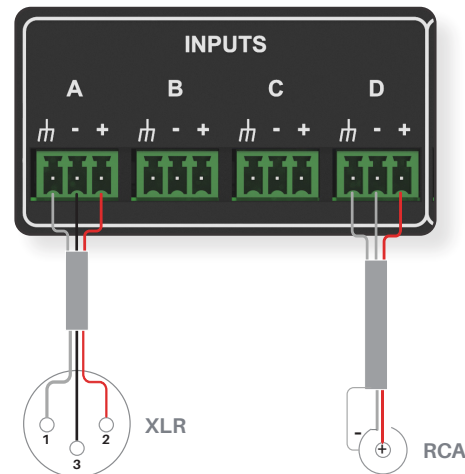

Balanced
 1 = Ground
 2 = Hot +
 3 = Cold -

Unbalanced
 Pin = Hot +
 Screen = Cold -
 Screen = Ground

- 4 Terminal block connector for REMOTE applications, EN-54 ready.



Standby

If you connect the two STBY pins, the amplifier will go into standby. The pins must be connected potential free. You may not apply voltage to them.

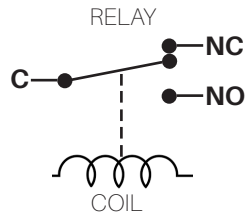

Relay

If the amplifier is turned off or if a fault is detected, the connection between C (center) and NC (normally closed) is established. When everything is functioning properly, the relay engages and the connection shifts to NO (normally open).

Please note: these features are slated for implementation in firmware versions beyond 1.3

- 5 RJ-45 Ethernet connectors are available for Dante™ network connectivity on the 'D' models.

Each Dante™ card comes with two network ports: one primary and one secondary. The secondary network port can be configured to provide redundancy for the primary network port. Creating a parallel network ensures that any cable or switch failure does not result in audio loss.

By default, the Dante card is configured in “switched” mode, allowing devices to be connected in a daisy-chain within a single network. However, it is not advisable to use daisy chain mode for more than a few devices.

To enable redundant mode, please configure the settings within Dante™ Controller.



When the device is connected to an active network, the yellow LINK LED above the in-use connector lights up. Data activity on the network is indicated by the illumination of the green ACT LED. It is normal for the ACT LED to flicker either sporadically or continuously.

The switched 100/1000 Base-T network connections automatically detect whether standard or crossover Cat-5e cables are in use. The green ACT LED flashes to signify network activity. When a 1000 Mbps connection is established, the orange LED remains solid to indicate a 1000 Mbps connection.

- 6 RJ-45 Ethernet connector for control via the web interface. Connect this port to your LAN.

The USB connector is intended for service only.

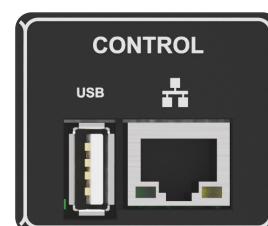

Processing & Signal Flow

The CloudPower™ offers DSP processing in three stages. Speaker specific processing can be provided by a manufacturer and loaded onto a channel using a SPEAKER PRESET. Additionally, users can apply two layers of processing: first, through the USER controls, affecting individual channels, and second, through six GROUP controls, which can affect multiple channels simultaneously.

The figure below depicts a simplified version of the signal flow:



USER Processing Features

The USER controls are channel-based features that apply to each channel individually. They can be operated by the user via the front panel and web interface and offer the following controls:

Mixer Matrix	Allows the summation of all available analog and digital inputs via faders.
Mute	Controls the mute status.
Gain	Controls the amount of gain, ranging from -80 dB to 15 dB.
Polarity	Flips the polarity 180°.
12 Band PEQ	12 bands of EQ with a choice of 16 different filter types per band including all-pass filters.
IIR HPF	X-Over infinite impulse response high-pass filter, with a choice of 19 filter variations.
IIR LPF	X-Over infinite impulse response low-pass filter, with a choice of 19 filter variations.
User Delay	Set a delay time up to 250 ms. Note: the USER delay time is shared with the GROUP delay time, their sum cannot exceed 250ms.
RMS Limiter	RMS limiter with adjustable threshold, attack and release times.
Peak Limiter	Peak limiter with adjustable threshold and release time. Note: the USER RMS and peak limiter are processed after the group processing block
70/100V HPF	An extra 100 Hz 12dB/oct high-pass filter to protect transformers from distortion and damage when driving a 70/100V system. Note: This filter is processed at the very end of the signal chain, after the SPEAKER processing and can only be activated via the web interface's settings menu: Settings (cog icon) > Output.

6x GROUP Processing Features

The GROUP controls are multi-channel features and will affect all channels assigned to them. Every channel of each amplifier in the network can be assigned to one or multiple groups, up to 6 in total. A group can have an unlimited number of channels assigned as members.

Groups can only be accessed through the web interface's sidebar menu and not via the front panel. They allow the user to operate multiple channels at once and offer the following controls:

Group Delay	Relatively add delay time up to 250 ms for every channel in the group. Note: the GROUP delay time is shared with the USER delay, their sum cannot exceed 250ms.
Mute	Mute every channel in the group.
Gain	Relatively add or subtract gain on every channel in the group, ranging from -80 dB to + 15 dB.
Polarity	Flips the polarity 180° for every channel in the group.
12 Band PEQ	12 bands of EQ for with a choice of 16 different filter types per band including all-pass filters, which effect every channel in the group.

Note: The group delay and gain settings are relative to the settings of the individual channels, the PEQ settings are absolute.

SPEAKER PRESET Processing Features

SPEAKER PRESETS are channel-based features that can be loaded onto individual channels using preset files that can be made in the preset creator or provided by OEM manufacturers. The user doesn't have direct access to these controls but can choose to load or clear the speaker preset from a channel. A speaker preset can contain the following features:

Gain	Controls the amount of gain, ranging from -80 dB to 15 dB.
Polarity	Flips the polarity 180°.
Speaker Delay	Set a delay time up to 30 ms. Note: the speaker delay is added on top of the combined 250 ms USER/GROUP delay.
12 Band PEQ	12 bands of EQ with a choice of 16 different filter types per band including all-pass filters.
IIR HPF	X-Over infinite impulse response high-pass filter, with a choice of 19 filter variations.
IIR LPF	X-Over infinite impulse response low-pass filter, with a choice of 19 filter variations.
FIR Filter	Allows to load a FIR filter file with 768 taps.
RMS Limiter	RMS limiter with adjustable threshold, attack and release times.
Peak Limiter	Peak limiter with adjustable threshold and release time. Note: these are the last limiters at the end of the signal chain.

Detailed Signal Path

The chart below illustrates the most extensive signal path possible for a single channel, utilizing the complete processing capability of the CloudPower™. Note that the group blocks consist of 6 layers, indicating that a single channel can undergo processing by all six groups simultaneously. The VU meters, which are visible in the web interface and on the front panel OLED display, are measured at the end of the signal path, just prior to the 70/100V high-pass-filter which closes the processing chain.

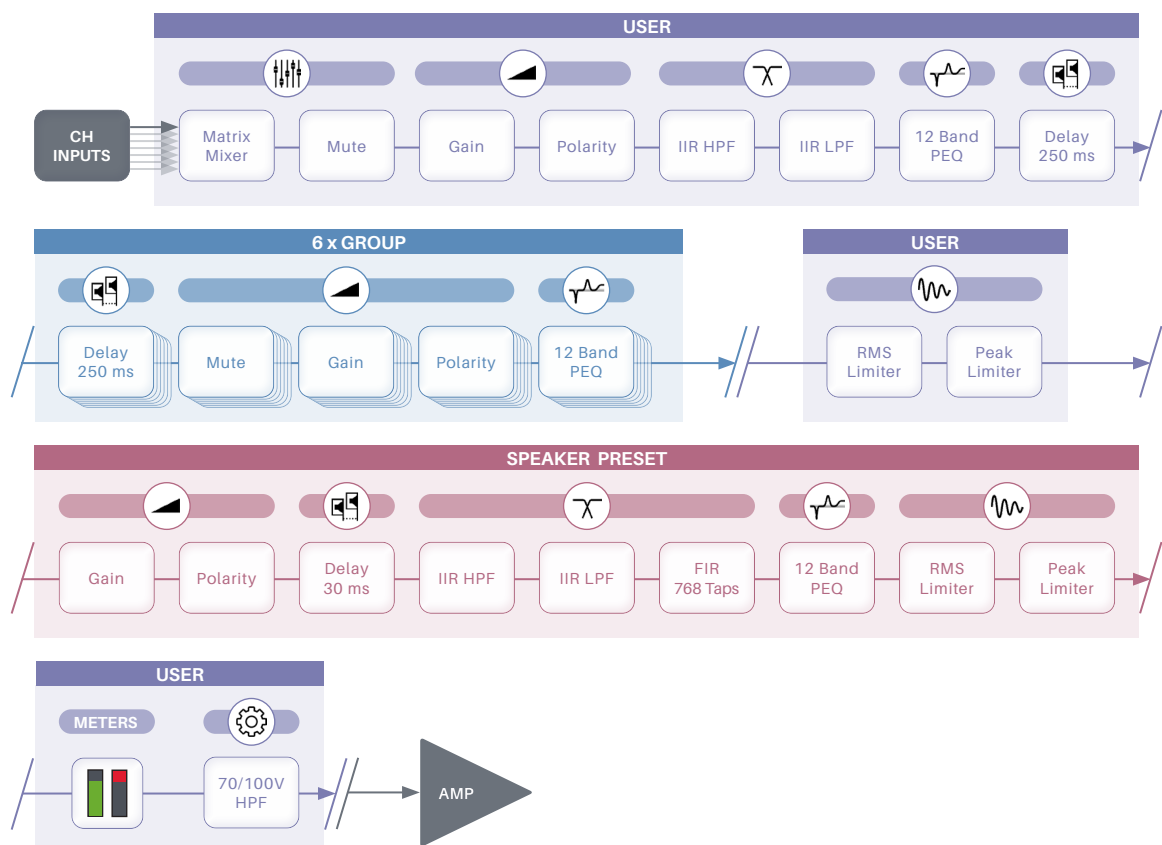

Processing Details

Delay from input to output

Min: 1 ms caused by latency, even with all processing features enabled (except for delay).

Max: 1 ms latency + 250 ms user/group delay + 30 ms speaker preset delay = 281 ms in total.



Max PEQ bands per channel

12 user bands + 6 x 12 group bands + 12 speaker preset bands = 96 PEQ bands in total.

Additional filters

+ 2 user crossover filters + 2 speaker crossover filters + speaker FIR filter + 70/100V HPF = a maximum of 102 possible filters on a single channel.

Max limiters per channel

User RMS & Peak + Speaker RMS & Peak = 4 limiters in total.

Limiter gain reduction metering

The gain reduction meters correspond to all limiters in the signal path, indicating the total limiter activity from input to output.

Gain scale

At 0 dB gain setting, the amplification from the line input to the amplifier output is 26 dB.

With a gain setting of +15 dB, the amplification reaches 41 dB.

Output Operation



70/100V System WARNING

When utilizing the amplifier with a 70 or 100V transformer system, ensure that you employ a high-pass filter (HPF) to prevent significant transformer saturation. Our recommended configuration is a 63Hz HPF with a 24dB/octave roll-off. The minimum response requirement is -3dB at 70Hz with a 12dB/octave slope.

Firmware version 1.3 and higher offer an additional 100Hz 12dB/octave HPF at the end stage of the processing for this purpose. You can activate this additional HPF through the web interface via Settings > Output.

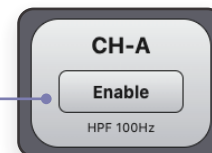

Presets



The CloudPower™ amplifier has two types of preset libraries, **Global Presets** and **Speaker Presets**.

Speaker Preset files contain specific DSP processing settings that can be applied to individual amplifier channels. End users have the option to select a loudspeaker type from a preset library, eliminating the need to configure parameters manually.

These speaker presets are developed by the speaker OEM and can be uploaded and stored in the amplifier's speaker preset folders via the WebUI. If necessary, users can further customize processing using the USER and GROUP controls. Speaker presets can be loaded onto a channel using either the web interface or the front panel.

Global Preset files contain all audio DSP settings for each of the amplifier's channels, including: USER, GROUP and SPEAKER PRESET parameters.

They **do not** contain any other settings found in the settings menu such as:

Output operation and configuration (100V HPF, bridge mode), network settings and streaming account details.

Operation Interfaces

A CloudPower™ device can be controlled through either of the following interfaces:

IntelliCloud Web Interface

The web interface serves as the primary method of operating the amplifier and can be accessed in the following ways:

- » Via a local network, whether wired or wireless
- » Through the cloud, allowing remote management from anywhere.
- » Using the internal hotspot, removing the need for an active network or wired connection.



Front Panel OLED & Rotary Encoder

Serves as an alternative control method that does not require additional devices or a network connection.

Front Panel Operation

While the CloudPower™ is primarily designed for use with its intuitive IntelliCloud web interface, the front panel provides a secondary method of controlling the amplifier's most important features without the need for network connectivity. It grants access to the amplifier's IP configuration and allows adjustment of most audio settings.

The colored **OLED display** ensures excellent readability, even in daylight conditions.



All controls are performed using a single **rotary encoder**. Rotate the encoder to navigate through the menus. Pressing the rotary controller inwards executes an **ENTER** action.

Please note:

Changes made from the front panel will be immediately visually updated in the web interface. However, when changes are made from the web UI while also interacting with the front panel, you will need to exit and re-enter the active menu on the front panel in order for the changes to become visible there.

 **Homepage**

The homepage displays the most important statuses of the amplifier, including the output level and mute status of all channels, along with the status of the network features.

The **STATUS ICONS** display the current status of the network, cloudconnect and hotspot respectively. When connected or active, the icons will turn green. A white icon indicates there is no connection or the feature is turned off.

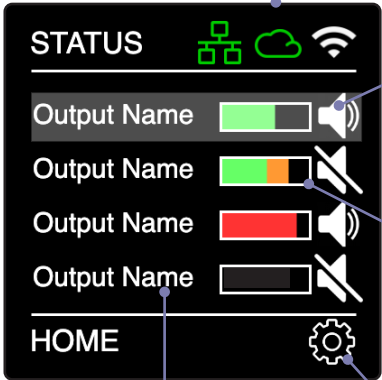

Pressing **ENTER** while a channel is selected will change its **MUTE STATUS**. The selected channel is marked by a grey rectangular background.

The **VU METER** provides a visual indication of the output level for each channel. The color of the VU bar indicates the amount of limiting that is applied.
Green : no limiting is applied.
Orange : 1 to 3 dB of gain reduction is applied.
Red : more than 3 dB of gain reduction is applied.
This indication is related to all limiters in the signal path, and thus, it indicates the total limiter activity from input to output.

Channel names, which can be customized using the web UI are displayed fully on the 4-channel models.

You can access the **SETTINGS MENU** by selecting the cog wheel and pressing **ENTER**. This is where you can access all audio and network features, as well as the preset libraries.

CP716D - 16 Channel Homepage

For CP716D, the homepage will only display the channel numbering (A, B, C to P) and their corresponding mute status. These mute statuses can also be adjusted directly from the homepage.





Settings Menu

The settings menu provides access to the audio processing features, global and speaker presets, and network features.

Turning the encoder will highlight the selected submenu. To enter the submenu, **press** the rotary encoder.



Select and press the **return icon** ↶ to navigate back one level in the menu and return to the homepage.



Settings / Audio Menu

Through the audio submenu, we can access audio processing and settings, including the mixing matrix, gain level, delay times, PEQ, crossover, limiter, and the signal generator.

Turn the rotary encoder to select and highlight the submenu you wish to access, then **press** the encoder to enter.

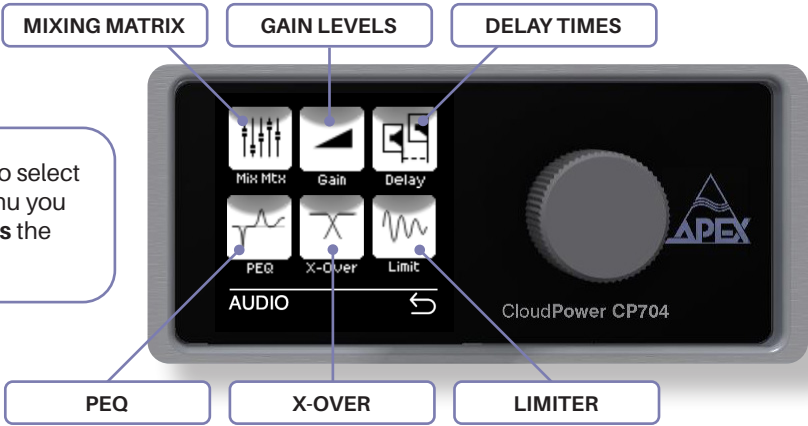

While in the Audio submenu, keep turning the rotary encoder to view the second page of the audio menu in order to access the **SIGNAL GENERATOR**.



Settings / Audio / Mixer Matrix

Each of the CloudPower™ channels has its own mixer matrix, allowing you to create a custom mix of input signals for every channel. You can access the mixing matrix through the front panel by navigating to Settings > Audio > Mix Mtx.

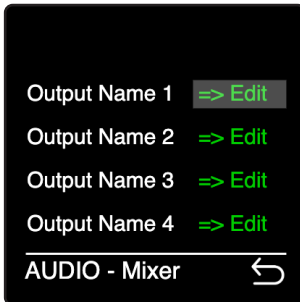

To edit a mixing matrix, select and press => **Edit** on the channel you want to adjust.



In the matrix, you can blend the available inputs for the selected channel:

- Analog inputs 1 to 4
- Network inputs 1 to 4, when fitted with a Dante™ card
- Stream L and R for Spotify or Apple AirPlay
- Internal sinewave and pink noise generator

To edit an input value, select the source you wish to edit and press to control it. Turn the rotary to increase or decrease the value and press again to confirm.

Select and press the return icon to navigate back in the menu.

CP716D - 16 Channel Network Input Routing

The CP716D provides 16 network inputs via Dante™. However, only one of the 16 network inputs will be accessible per channel as illustrated in the figure to the right.

If any two channels require the same network input, this configuration must be set up in an audio network router, such as Dante™ Controller.

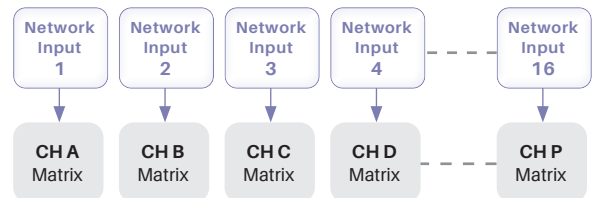

CP716D Network Input Routing



Settings / Audio / Gain

The gain setting adjusts the level of amplification for each channel. The default gain setting is 0 dB, but it can be changed to any value ranging from -80 dB to +15 dB in 1 dB increments.

Please exercise caution, as increasing the gain will result in a higher voltage output from the output terminals. To access the gain function via the front panel, navigate to Settings > Audio > Gain.

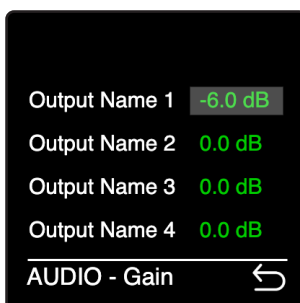

To edit a **gain** value, select the channel you wish to edit and press the dB value to control it. Turn the rotary to increase or decrease the value and press again to confirm.

Select and press the return icon to navigate back in the menu.

Gain Scale

At 0 dB gain setting, the amplification from the line input to the amplifier output is 26 dB. At +15 dB, the amplification reaches 41 dB.



Settings / Audio / Delay

Each output channel of the CloudPower™ can have a delay of up to 250 ms inserted by the user. Note: the total delay of 250 ms per channel is shared between the user delay and group delay. You can access the user delay function through the front panel by navigating to Settings > Audio > Delay.

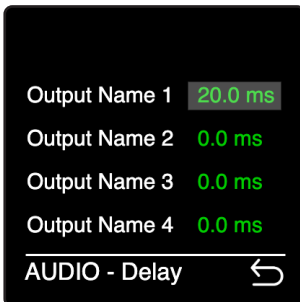

To edit a **delay** time, select the channel you wish to edit and press the ms value to control it. Turn the rotary to increase or decrease the value and press again to confirm. Select and press the return icon to navigate back in the menu.



Settings / Audio / PEQ

The CloudPower™ offers a 12 band PEQ per channel, providing a wide variety of filter types to choose from, including all-pass filters designed to address phase issues. You can access this function through the front panel by navigating to Settings > Audio > PEQ.

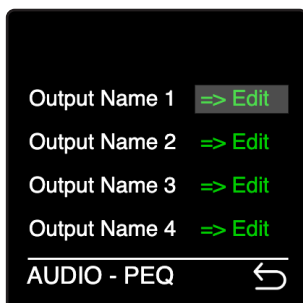

To edit a PEQ, select and press => **Edit** on the channel you want to adjust

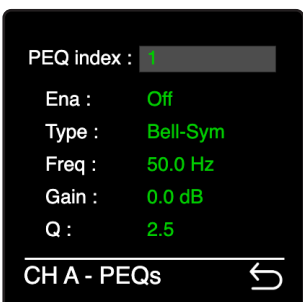

There are 12 bands of EQ available for each channel.

PEQ index indicates which of the bands is being edited. Press and scroll from 1 to 12 in order to access the other bands.

Ena, enables or disables the selected EQ band.

Type, allows you to choose from 16 filtering types: Bell-Sym, Bell-Asym, Notch, Low-Shelf 6dB or 12dB, High-Shelf 6dB or 12dB, All-Pass 90° or 180°, High-Pass 6dB or 12dB, High-Pass Vari-Q 12dB, Low-Pass 6dB or 12dB, Low-Pass Vari-Q 12dB and Band-Pass.

Freq controls the filter frequency, and is adjustable from 10 Hz to 22 kHz for each band.

Gain can be set between -40 and +15 dB.

Q controls the filter's Q-factor and can be set between 0.1 and 48.



Settings / Audio / X-Over

The CloudPower™ provides a crossover with both a high-pass filter (HPF) and low-pass filter (LPF) for every channel. You can access this function through the front panel by navigating to Settings > Audio > X-Over.

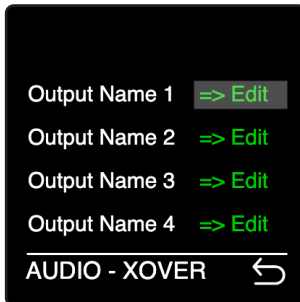

To edit a crossover, select and press => **Edit** on the channel you want to adjust



XOVER indicates which of the 2 filters is being edited.

Press and scroll to select between the high-pass and low-pass filter. Both can be active simultaneously.

Ena, enables or disables the selected filter.

Type, allows you to choose from 19 filtering types:

Butterworth, Bessel and Linkwitz-Riley filters with slopes from 6dB/oct to 48 dB/oct.

Freq controls the crossover frequency and is adjustable from 10 Hz to 22 kHz.

70/100V System Warning

When utilizing the amplifier with a 70 or 100V transformer system, ensure that you employ a high-pass filter (HPF) to prevent significant transformer saturation. Our recommended configuration is a 63Hz HPF with a 24dB/octave roll-off. The minimum response requirement is -3dB at 70Hz with a 12dB/octave slope.

Firmware version 1.3 and higher offers an additional 100Hz 12dB/octave HPF at the end stage of the processing for this purpose. You can activate this additional HPF through the web interface via Settings > Output.



Settings / Audio / Limiter

Each of the CloudPower™ channels can potentially have four active limiters, two of which are the user RMS and Peak limiters. They are accessible from the front panel via Settings > Audio > Lim.

The user can choose to manually set the limiters or have the CloudPower™ calculate a safe setting for the specific speaker connected to the channel. This is achieved through the **LIM mode** feature.

Please note that the limiters are always active. To prevent them from affecting the sound, you can set their thresholds to the highest possible level.

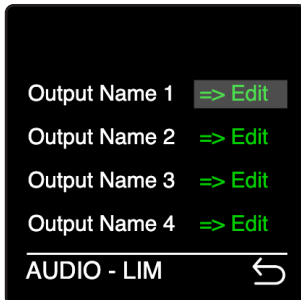

To adjust a limiter, select and press => **Edit** on the channel you want to adjust

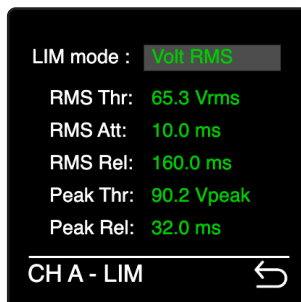

LIM mode: enables you to set the limiter manually by adjusting the Vrms threshold, or allows the CloudPower™ to calculate a setting based on the impedance and wattage of your speaker. To achieve this, select the preset that has the same Ohm value as the connected speaker, and then set the correct Wrms and Wpeak values in the controls below.

RMS Thr: sets the Vrms or Wrms threshold for the RMS limiter.

RMS Att: sets the attack time for the RMS limiter.

RMS Rel: sets the release time for the RMS limiter.

Peak Thr: set the Vpeak or Wpeak threshold for the peak limiter.

Peak Rel: sets the release time for the peak limiter.

When changing the limiter mode, these values will change accordingly.



Settings / Audio / Signal Generator

Each CloudPower™ amplifier is equipped with a built-in signal generator, accessible through Settings > Sig. Gen. The output from this signal generator can be independently audible on each channel through the matrix mixer.

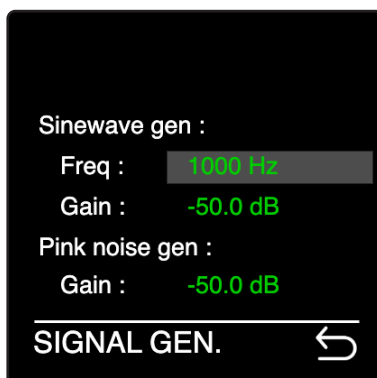

You have access to both a pink noise and a sine wave generator with eight selectable frequencies: 50, 100, 200, 500, 1000, 2000, 5000, or 10000 Hz. The level for the sine wave can be adjusted within the range of -50 dB to -20 dB, while the pink noise level can be adjusted within the range of -50 dB to -10 dB.

Returning to the matrix mixer menu via Audio > Mix Mtx. allows you to make the generator audible on any channel.

Following a reboot, the signal generator gains are reset to -50 dB as a safety precaution.



Settings / Presets Menu

The CloudPower™ amplifier features two types of preset libraries: Global and Speaker Presets. For further details, please refer to pages 16, 52 (global) and 59 (speaker) in this manual.

Access the Global and Speaker Presets from the front panel via Settings > Presets.

The initial **Presets** submenu allows you to access either the global or speaker preset library. Highlight and press to enter the desired library.



Global Preset Menu

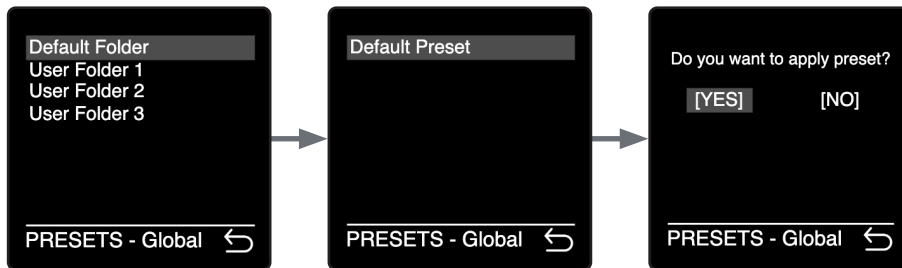

To recall a global preset: Select a global preset folder > Select a preset to load > And finally, press YES to confirm your choice and load the preset.

To restore the amplifier to its standard settings, load the **Default Preset** from the **Default Folder**.

When loading global presets, the amplifier will mute all outputs in order to prevent loud noises and speaker damage due to possible high gain settings.

Speaker Preset Menu

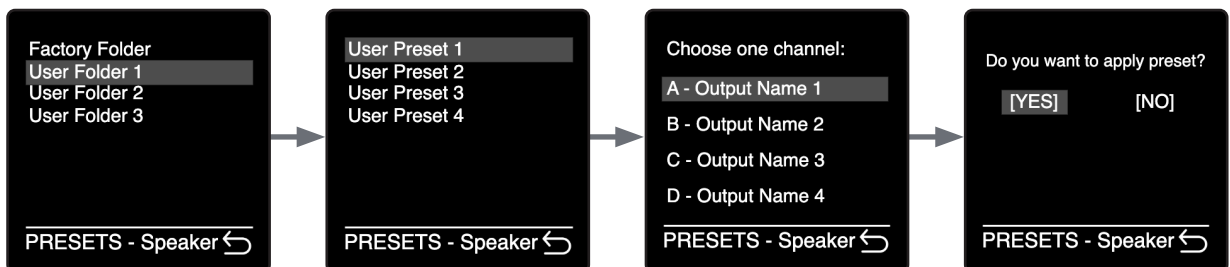

To insert a speaker preset onto a channel: Select a speaker preset folder > Select a preset > Select the channel on which you wish to load the preset > And finally, press YES to confirm your choice and insert the preset.

To clear a channel of a preset, load the **Blank Preset** from the **Factory Folder**.

Please note:

The front panel only allows the user to load presets. The creation of presets is done through the web interface.



Settings / Hotspot

Each CloudPower™ amplifier features a Hotspot, enabling users to control the amplifier using any mobile device (smartphone, tablet, or laptop) without needing access to the local network to which the amplifier is connected through its CONTROL port. The CloudPower™ IntelliCloud software is web-based, eliminating the need for software installation. You can enable the hotspot from the front panel by navigating to Settings > Hotspot.

Hotspot	<input checked="" type="checkbox"/>
SSID	AMP_XXXX
Password	12345678
HOTSPOT ↵	

Press **return** ↵ to apply the changes.

Switch the **Hotspot** to **ON** using the rotary encoder, then search for the **SSID** name within your device's available Wi-Fi networks. Connect to the hotspot and enter IP address **172.24.0.1** in your browser. This will automatically open the IntelliCloud web interface on your device.

SSID is the name of the generated hotspot, which you can find in your list of available Wi-Fi networks.

The **Password** will be prompted by your device when attempting to connect to the hotspot.

Both the SSID and Password can be modified via the web interface. By default, these are set to "**AMP_XXXX**" and "**12345678**".

Please note that the web interface will also prompt you for a login and password. By default, both are set to "**admin**" and can be altered in the web UI settings menu > **Credentials**.



Settings / Cloud

Every CloudPower™ amplifier is equipped with a Cloud feature. This feature enables users to remotely manage the amplifier via the internet. To enable this, the CONTROL port (on the rear of the amplifier) must be connected to a router with an internet connection. Using a secure connection, users can operate the amplifier and all other CloudPower™ devices within the same network from anywhere in the world.

Cloud	<input checked="" type="checkbox"/>
Name	cloudname
User	admin
Password	admin
CLOUD ↵	

Press **return** ↵ to apply the changes.

The front panel only provides control over the cloud function's **ON/OFF** setting.

With the Cloud feature turned **ON**, open a web browser connected to the internet and enter the following URL:

http://cloudname.apexconnect.me

This will enable you to connect to the amplifier, which will prompt you for the **User** login and **Password**. By default, both are set to "**admin**".

They can be modified by accessing the web UI through Settings > Network > Credentials.

The **cloudname** is a unique name that must be given to the amplifier via the web UI settings menu. When assigning cloud names to your amplifiers, make sure to create unique names by including detailed descriptions or codes. This ensures that no two CloudPower™ amplifiers in the world share the same cloud name. For example: "AmpCompanyLocationA1202"

Please note:

When multiple CloudPower™ amplifiers are installed within a single network, accessing one amplifier through the Cloud will provide access to all other amplifiers via the sidebar menu in the IntelliCloud web UI. However, we recommend enabling the cloud feature for all amplifiers individually. This allows each amplifier to be accessed directly, without relying on the functionality of another unit.



Settings / Network

The Network menu gives access to the IP setting of the CloudPower™ which can be set from the front panel by navigating to Settings > Network.

Connect via a router

Connect the CloudPower™ device's CONTROL connector together with a PC to a router. The use of a router is mandatory in DHCP mode to obtain IP addresses. After a connection is established with the router, the CloudPower™ device will receive an IP address that will be displayed in the network menu. Enter this address in your device's browser, and the IntelliCloud software will open on your device. The IntelliCloud software is web-based, so there is no need for software installation.

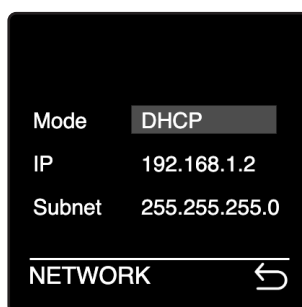

Press **return** ← to apply the changes.

Mode

Use the rotary encoder to choose between **DHCP** and **Static** modes.

IP

In DHCP mode, an IP address will be automatically displayed when a connection is established with the router.

In static mode, you need to manually enter an IP address.

Subnet

For DHCP mode, the subnet will also be automatically displayed when the connection is established.

In static mode, you must manually enter the subnet mask.



Settings / About

The About menu will display the current firmware version of the device. You can access this menu by navigating to Settings > About.



Notes on Networking

Providing that the network is properly configured, IntelliCloud is capable of automatically detecting and controlling any CloudPower™ device connected to the network. Please refer to the IntelliCloud documentation for more details on controlling the CloudPower™ remotely.

Quick setup tip :

- Connect your PC together with the CloudPower™ device/s to a wired or wireless router.
- Set all connected devices and your PC to DHCP.
- Open your browser and enter the IP address that is displayed on the network submenu of any of the connected devices.
- The IntelliCloud software will open automatically on your control device. The default login and password are "admin"

Configuring simple IP networks is something that most system engineers would be aware of. Explaining the details of IP networking is therefore outside the scope of this manual. However, we believe it is important to address certain key aspects for better understanding.

IP Addresses

All computers, whether they are Windows, Linux or Mac OS based, and most network-based devices such as the CloudPower™, obtain an IP address by the following means:

- If a static IP address has been assigned to the computer or device, then that IP address must always be used. Static IP addresses are fixed and do not change. This is useful when installing CloudPower™ devices into fixed installations whereby all networked audio equipment has been assigned a unique and unchanging IP address. This is very useful for network management.
- If the device or computer is set to automatic mode (whereby no static IP address has been defined) then a unique IP address will be used; however this address may vary every time the device is connected to the network. If a DHCP server is available on the network then the CloudPower™ device will use the IP address provided by it.

Further information

In most applications, communication between the CloudPower™ and IntelliCloud software will not require any configuration and will effectively work 'out of the box'. However, when the CloudPower™ is used in more network critical environments (e.g., broadcast or AV installations) some additional network settings may be required and the information provided below may be of interest.

The communication protocol used by the CloudPower™ is UDP/IP based. It is based on Unicast communications (point-to-point) for the remote control of properties (e.g., modifying an input gain or the frequency of a filter) and Multicast (point-to-multipoint) for auto-discovery of devices and property changes (such as driving meters within IntelliCloud). Multicasting is preferred over broadcasting as it is more suited for network bandwidth control.

Ethernet cables

Nowadays, computers and network devices automatically detect the type of connection (irrespective of whether straight or crossover Ethernet cabling is used). The CloudPower™ operates in the same manner, hence there is no need to worry about cable wiring when out in the field.

Remember that there are limits to Ethernet cable length between two devices and this is 95 meters. Any connection will add about 10 m.

Going wireless

Using wireless networks may be challenging, but the key to success is to use good quality rugged wireless access points and to configure them correctly.

Configuring an access or router point is not that difficult. There is no requirement to install any software as the computer's web browser is sufficient (all access points have a built-in web-server). Just type in the IP address of your access point into your web browser and you'll be able to configure the device.

In some applications, there may be a requirement to boost the signal level of both the access point and computer (outdoor stadium shows for example). External boosters are available but these will require that the original antenna of the access point or computer be removed (this has a bearing on the type of access point chosen). Note: always check local regulations concerning maximum permitted wireless signal power before up-rating your equipment.

IntelliCloud Web Interface

The primary mode of operating a CloudPower™ amplifier is through the user-friendly IntelliCloud interface. This fully web-based software is hosted by the CloudPower™ amplifier itself and can be accessed by any device with a browser. This eliminates the requirement for any software installation, regardless of which operating system you are using.

The interface is responsive and can be easily used with a wide range of devices, including desktop computers, laptops, and landscape-oriented tablets and phones.





Accessing the Web UI

To access the IntelliCloud interface, you need to establish a connection between your device and the amplifier's server. This can be accomplished using one of the methods outlined below.

For more information, please refer to the **Web UI / Settings / Network** section of this manual.

Via a LAN



1. Connect the CONTROL port of the amplifier to the same LAN as your device.
2. If the IP mode is set to DHCP (default), the amplifier will get an IP address assigned by the router. You can view this IP address from the amplifier's front panel: Settings > Network. If the mode is set to Static, you might need to adjust the IP address from the front panel.
3. Enter the amplifier's IP address into your web browser's URL.
4. Enter the login credentials to access the web interface, both are set to "admin" by default.

Remotely via the Cloud, from anywhere in the world



1. Both the amplifier's CONTROL port and your device must be connected to a router which has access to the internet.
2. The amplifier's cloud feature must be turned on. You can access this setting from the amplifier's front panel: Settings > Cloud.
3. Enter the amplifier's cloudconnect link into your web browser's URL:
http://cloudname.apexconnect.me
4. Enter the login credentials to access the web interface, both are set to "admin" by default.
Note: You will be prompted for the login credentials twice — first by the relay server, and then by the amplifier's server. Both sets of credentials are the same.

Via the amplifier's internal Hotspot, wireless



1. Ensure that the amplifier's internal hotspot is activated. This can be done through the front panel under Settings > Hotspot.
2. Look for the Hotspot's SSID name among your device's Wi-Fi networks. By default, this name is set to "AMP_XXXX".
3. Connect to the hotspot and enter its password. By default, this is set to "12345678".
4. Enter IP address **172.24.0.1** into your web browser's URL.
5. Enter the login credentials to access the web interface, both are set to "admin" by default.

Directly via a network cable



1. Connect the ethernet port of your computer directly to the CONTROL port of the amplifier using a network cable.
2. Make sure the amplifier is in DHCP mode (default), which can be adjusted through the front panel under Settings > Network.
3. In a brief period, the amplifier will be assigned an automatic IP address within the 169.x.x.x range.
4. Note this address from the front panel and enter it into your web browser's URL.
5. Enter the login credentials to access the web interface, both are set to "admin" by default.



Login

When connection has been established, the interface will prompt you for the login and password.

By default, both are set to: **admin**

You can change these credentials via the web interface > Settings > Network

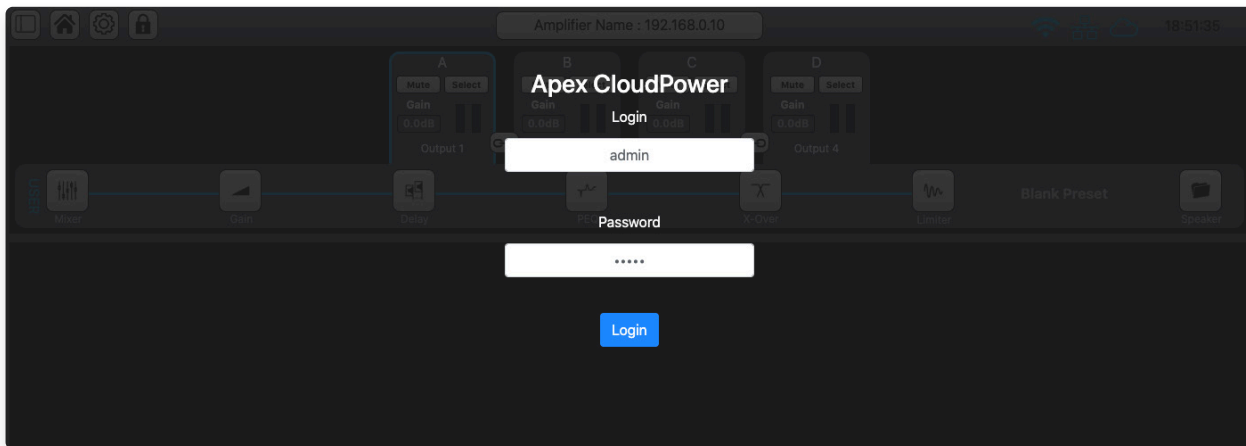

Browser Info and Advice

- For optimal performance, we recommend using Google Chrome or Mozilla Firefox.
- On desktops and laptops, use a full HD (1920 × 1080 px) window size for the best user experience.
- After a firmware update, it is advised to clear your browser cache if you have been using a previous version of the IntelliCloud software on the same device. This will ensure that the interface is displayed correctly.
- Avoid opening multiple browser tabs connecting to the same device on the same network.

Screen Orientation Message

The software is designed to operate in landscape mode on smartphones and tablets. If you hold your device in portrait mode, the interface will display a reminder.

If you see this message on your desktop computer or laptop, it means your browser window is too narrow. Increase the width of the window to display the interface.

APEX CloudPower is only viewable in landscape mode

 **Homepage | USER Processing**

After logging in, the Homepage will be displayed. This is where you have an overview of all the channels and can access the various USER submenus.

The image below displays the homepage for the 4 channel models. The top section allows you to navigate submenus, mute and select channels. This top section remains visible as you move through all the USER submenus. The bottom section shows the submenu that's currently chosen for the selected channel. For instance, in this case, it's displaying the Mixer for channel A.



Irrelevant parts of the interface have been faded for demonstration purposes.

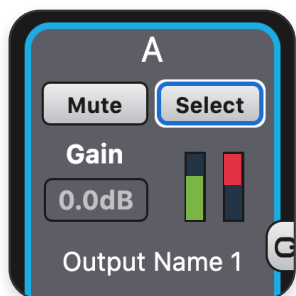

Channel Header - 4 channel models

- Press **Mute** to silence the channel. The button turns red when muted.
- **Select** a channel to take control over it's USER functions. The selected channels is highlighted with a blue outline.
- The amount of **Gain** is displayed but cannot be controlled here.
- The **VU meters** give an indication of the output voltage and limiting.
- The channel numbering (A,B,C ...) is displayed at the top, the customisable channel label at the bottom.

USER Processing Submenus

The USER menu contains all channel-based processing options available to the user. The Mixer, PEQ, X-Over, Limiter, and Speaker menus pertain to individual channels; ensure you have the correct channel selected. The Gain and Delay menus display controls for all channels simultaneously.

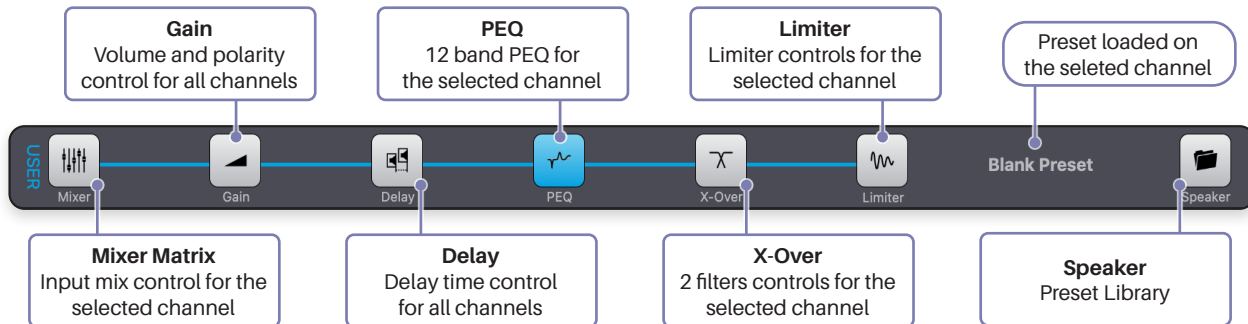

16 Channel Homepage Variation

Depicted below is the homepage for the 16 channel amplifiers. In order to save screenspace, the channel headers are simplified. Note the grey channel background alternates in tint every 4 channels to help you orientate.

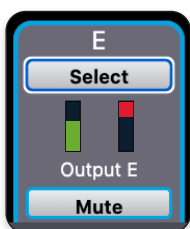

Channel Header - 16 channel CP716D

- **Select** a channel to take control over its user functions. The selected channels is highlighted with a blue line.
- Press **Mute** to silence the channel. It turns red when muted.
- The **VU meters** give an indication of the output voltage and limiting.
- The channel numbering (A,B,C ...) is displayed at the top, the customisable channel label at the bottom.

Momentary Parameter Linking

The 4-channel amplifier models provide a momentary linking feature between channels A-B and C-D. When activated, any action performed on one channel will be duplicated on the linked channel. Parameters that are not touched will not synchronize and remain in their individual positions.

This linking feature is designed as a temporary control to speed up the setup process when adjacent channels require the same parameter adjustments.

It is not intended for permanent stereo linking and should not be used as such. Its status will not be stored in the global settings.



Press the **Link** button to activate momentary parameter linking. When activated, the button will turn orange and begin flashing.

USER / Mixer Matrix

The **Mixer** matrix enables users to route and blend input signals for each individual channel. Within its side menu, you can rename channels and access the internal signal generator.

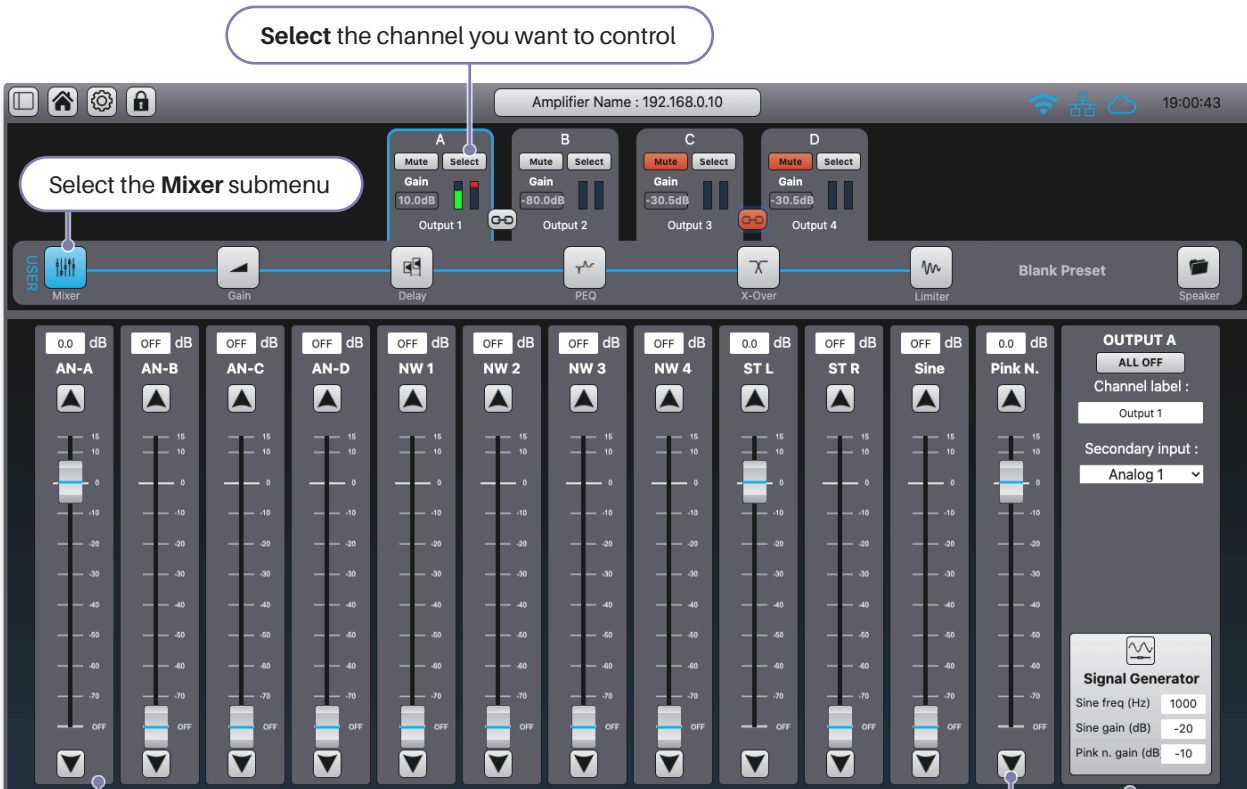

Select the channel you want to control

Select the Mixer submenu

All faders can be operated in five different ways:

- Slide using your mouse or finger.
- Tap the arrow buttons for small increments.
- Enter a specific value in the data input field at the top.
- Use the up and down keyboard arrows when a fader is selected.
- Double-click on a fader to set it to unity (0.0 dB).

Available Mixer Inputs

- AN Four analog line inputs located on the rear of the amplifier.
- NW Dante™ network line inputs (4 for 4 ch. amps, 1 per channel for 16 ch. amps).
- ST Spotify and Apple Airplay streaming Left and Right inputs.
- Internal sine wave generator.
- Internal pink noise generator.

ALL OFF acts as a reset and sets every input fader for the selected channel to OFF, the lowest position.

Channel label allows you to give the channel a custom name. This name is displayed in the channel header, the GROUPS routing and on the front panel display (for the 4ch. models).

The **Secondary input** will act as an automatic backup input in case of an audio network connection failure. *Please note: this feature is slated for implementation in firmware versions beyond 1.3*

The settings of the internal **Signal Generator** can be customized. The volumes are intentionally kept low and are restricted to -20 dB (sine) and -10 dB (pink noise) for safety precautions, and will reset to their default of -50 dB after a reboot.

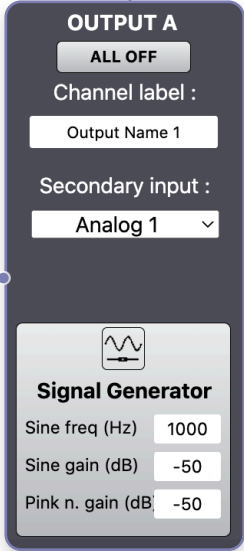

USER / Gain

The **Gain** submenu show the master input faders for every channels. This is where you will control the volume for each amplifier output. Note: the gain values can be offset if the channel is assigned to a GROUP with gain settings other than unity (0.0 dB).

You do not have to select a channel, every channel's gain control is visible from the same submenu.

Polarity inverts the channel's phase by 180°.

Adjust the faders to reach the desired **output volume**.

Be cautious when double-clicking the fader, as it will set it to unity gain and could potentially result in a high voltage output if an audio source is presented. It would also be wise to check and set the channel's limiters before applying high gain levels.

Gain Scale

At 0 dB gain setting, the amplification from the line input to the amplifier output is 26 dB. At +15 dB, the amplification reaches 41 dB.



USER / Delay

The **Delay** submenu enables users to set a delay time for each channel, ranging from 0 to 250 ms, with increments of 0.1 ms. The limit of 250 ms is shared between the USER and GROUP delay.

You do not have to select a channel, every channel's delay control is visible from the same submenu.



Set the desired **delay time** for each channel using the fader, arrows, keyboard, or input field. Double-click on the fader to reset it to 0 ms.

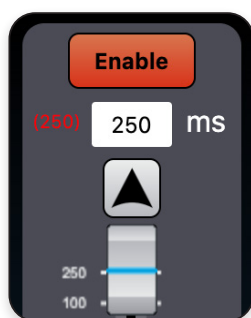

Enable turns the delay on and off, allowing for A-B comparisons.

The value inside the parentheses () beside the data input field indicates the sum of GROUP delay and USER delay, which cannot surpass 250 ms.

For example: If this channel is assigned to a group that has a 50 ms delay time, you will not be able to set the USER delay higher than 200 ms.

Front Panel Delay Control

The delay time can also be set from the front panel, though it does not offer the Enable button. If you increase the delay time from the front panel to anything above 0 ms, the Enable button will be automatically activated. Similarly, reducing the delay time back to 0 ms from the front panel will switch off the Enable button.



USER / PEQ

The CloudPower™ offers 12 bands of USER EQ per channel, with a wide variation of filter types to choose from.

Select the channel you want to control

Select the PEQ submenu

Drag EQ nodes

Band	Filter type	Freq. (Hz)	Gain (dB)	Q
1	Bell-Sym	50	6	1
2	Bell-Sym	100	0	2,5
3	Bell-Sym	200	0	2,5
4	All-Pass 180°	250	0	2,5
5	Bell-Sym	400	0	2,5
6	Notch	500	0	2,5
7	Bell-ASym	1000	-10	2,5
8	Bell-ASym	2000	10	2,5
9	Bell-Sym	3000	0	2,5
10	High-Shelving 12dB/oct	4000	-6	2,5
11	Bell-Sym	5000	0	2,5
12	Low-Pass VariQ 12dB/oct	12000	0	1,5

Band	Filter type	Freq. (Hz)	Gain (dB)	Q
1	Bell-Sym	50	6	1
2	Bell-Sym	100	0	2,5
3	Bell-Sym	200	0	2,5
4	All-Pass 180°	250	0	2,5
5	Bell-Sym	400	0	2,5
6	Notch	500	0	2,5
7	Bell-ASym	1000	-10	2,5
8	Bell-ASym	2000	10	2,5
9	Bell-Sym	3000	0	2,5
10	High-Shelving 12dB/oct	4000	-6	2,5
11	Bell-Sym	5000	0	2,5
12	Low-Pass VariQ 12dB/oct	12000	0	1,5

The EQ bands can be set in multiple ways:

- Enter the data into in the ALL tab.
- Drag the EQ nodes on the chart.
- Select a specific band's tab and utilize the detailed controls.
- Copy the settings from another channel.

The ALL tab provides an overview of all 12 band settings and allows control over the full PEQ.

To activate a band, click the **checkbox**.

Select a **Filter Type** from the list.

Adjust the **Frequency** within the range of 10 Hz to 22 kHz.

Set the **Gain** between -40 and +15 dB.

Select a **Q-factor** value between 0.1 and 48.

Tap a filter band for detailed control, which can be particularly useful when using tablets or phones. The tab will turn green when its filter is activated, and the selected tab will be outlined in blue.

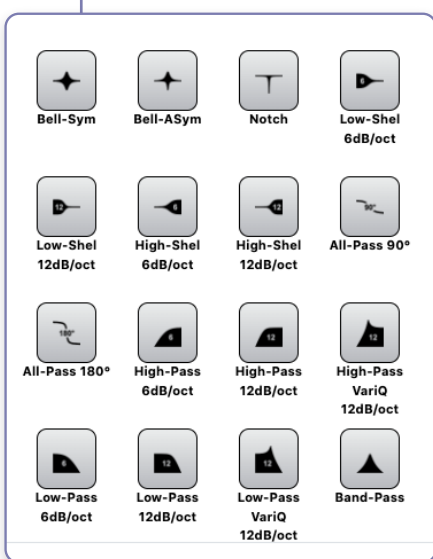
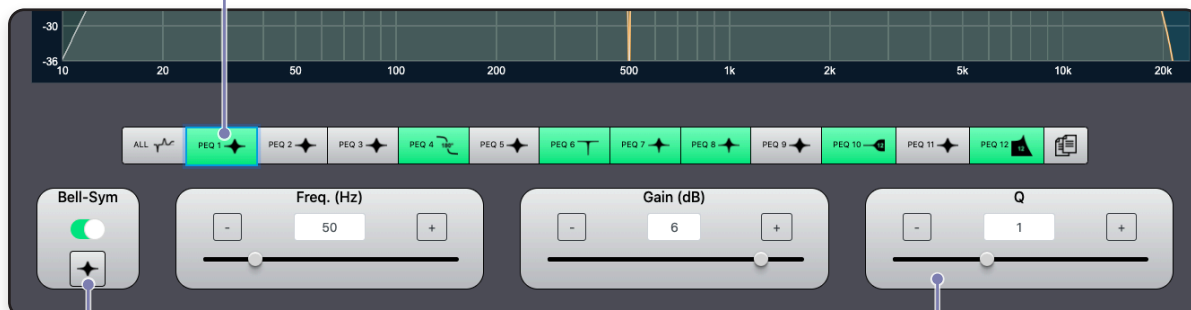

Use the three value boxes to enter the data by sliding the fader, clicking the - and + buttons for small increments or entering the data in the input field.

Clicking or swiping the latch switch will **activate** the selected filter and display the curve on the chart. Click the **filter** icon to bring up the filter selection window.

Click on the last tab to access the **Copy** feature and **Reset** controls.

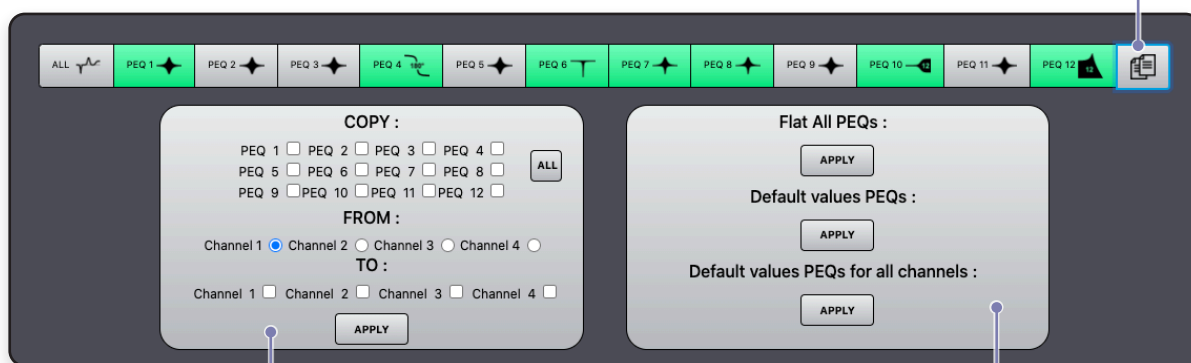

To **copy** PEQ bands, select the bands and the source channel from which you wish to copy, then select the destination channels where these band settings will be pasted. Finally, click **Apply** to execute the copy command.

Flat All PEQs sets the gain of all 12 bands of the active channel to 0 dB. It will not affect the frequency and Q settings, or other channel PEQs.
Default values PEQs resets all PEQ settings for the channel. It will not affect other channels.
Default values PEQs for all channels resets all PEQ settings on every channel.

Chart Features

Both the PEQ and the X-Over charts offer features to enhance usability and provide feedback.



The active nodes on the chart can be moved by **dragging** them with your finger or mouse.



Lock **horizontal** movement of the notes in order to avoid changing the **frequency**.



Lock **vertical** movement of the notes in order to avoid changing the **gain**.



The **view options** allow you to choose between viewing the magnitude, phase, or both. You can also control the range for both magnitude and phase scales.

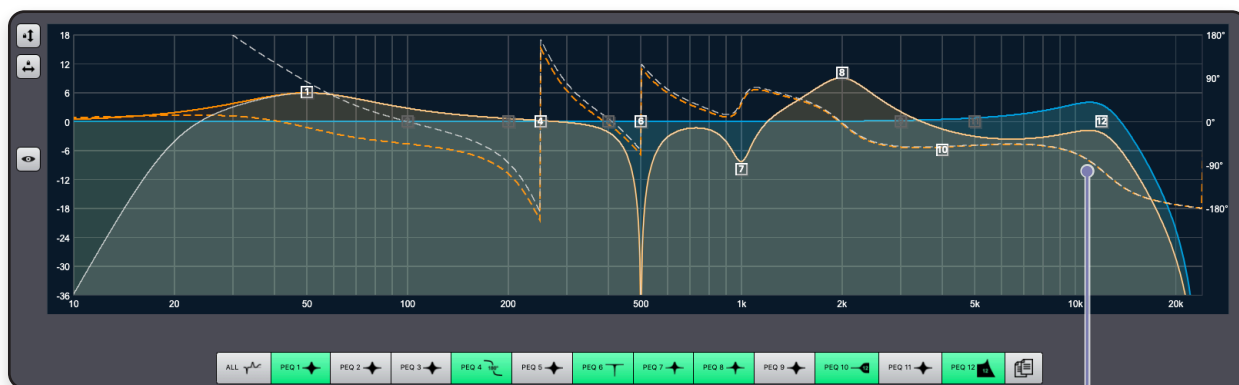
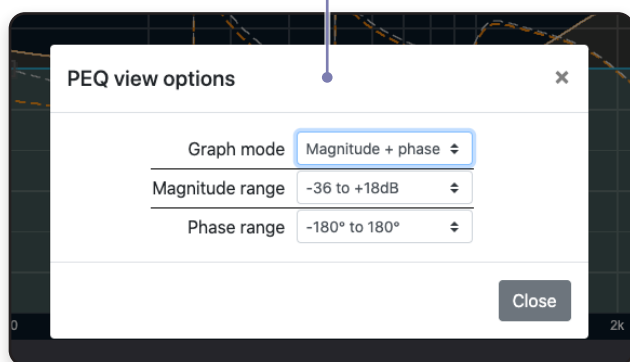

The lines on the chart are color-coded to maintain clarity:

- Orange: Indicates the total effect of either the PEQ or X-Over, depending on the **active** menu.
- White: Reflects the **combined effect** of both the PEQ and X-Over.
- Blue: Highlights the currently **selected band** or filter.
- Solid line: Illustrates the effect on the **Magnitude**, with its scale on the left of the chart.
- Dotted line: Depicts the **Phase** shift, with its scale on the right of the chart.

USER / X-Over

The CloudPower™ amplifier provides both a **high-pass** and a **low-pass filters** in its user interface. These filters offer a choice of 19 different classic X-over filter types, including Bessel, Butterworth, and Linkwitz Riley, with slopes ranging from 6 to 48 dB/octave.

Select the channel you want to control

Select the X-Over submenu

Drag filter nodes

Clicking or swiping the **latch switch** will activate the selected filter and display its curve on the chart.

To set the **cutoff frequency**, you can drag the nodes on the chart, use the slider, - and + buttons, or manually enter the value in the input field.

Both filters can be set from 10 Hz to 22 kHz.

Click the **filter icon** to bring up the filter selection window

70/100V System Warning

When utilizing the amplifier with a 70 or 100V transformer system, ensure that you employ a high-pass filter (HPF) to prevent significant transformer saturation. Our recommended configuration is a 63Hz HPF with a 24dB/octave roll-off. The minimum response requirement is -3dB at 70Hz with a 12dB/octave slope. Firmware version 1.3 and higher offer an additional 100Hz 12dB/octave HPF at the end stage of the processing for this purpose. You can activate this additional HPF through the web interface via Settings > Output.



USER / Limiter

To protect the connected loudspeakers from damage, each CloudPower™ channel is equipped with a dual-stage **Limiter** that includes an RMS stage which responds to the signal's average power, and a Peak stage designed to react to fast signal spikes and transients.

Select the channel you want to control

Select the **Limiter** submenu

RMS Lim. Peak Lim. Output dBfs

RMS stage

Output (Vrms) 10

Attack (ms) 0,1

Release (ms) 160

Peak stage

Output (Vpeak) 10

Release (ms) 32

The **red meters** show the selected channel's RMS and Peak gain reduction in dB, while the **green meter** displays the output level after limiting in dBFS.

The **calculators** can be used to calculate settings specific to your speaker.

Output (Vrms) and **(Vpeak)** serve as **threshold** controls that determine the signal level at which the limiter engages. These thresholds can be adjusted within the range of -56 to +24 dBu.

It's important to ensure that the Peak threshold is set higher than the RMS threshold.

If not, the RMS limiter won't have an impact as the faster responding Peak limiter will eat its dinner.

Attack can only be set for the RMS stage and determines the speed at which the limiter responds when the signal level surpasses the RMS threshold. It can be set between 0.1 and 6.000 ms.

The Peak limiter is naturally equipped with a very fast attack setting.

Release determines the time it takes for the limiter to recover once the signal falls back below the threshold. Faster release settings might lead to audible distortion or a pumping effect, which can be smoothed by using slower release times.

The range for the RMS stage is 5 to 10,000 ms.

The range for the Peak stage is 5 to 500 ms.

Limiter Calculator Tool

Clicking the calculator icon opens a window where you can calculate appropriate starting values for your limiter. This calculation is based on the impedance and the maximum output wattage of your speaker and the high-pass filter settings from the crossover menu.

The image shows two calculator windows overlaid on a mixer interface. The top window is the 'RMS Limiter Calculator' with the following fields: Max Output Power (Wrms) set to 150, Load set to 8 Ω, Output Vrms set to 34.6, Highpass Frequency set to 50, Attack (ms) set to 20.0, and Release (ms) set to 320.0. The bottom window is the 'Peak Limiter Calculator' with the following fields: Max Output Power (Wpeak) set to 300, Load set to 8 Ω, Output Vpeak set to 49.0, Highpass Frequency set to 50, and Release (ms) set to 320.0. The Peak calculator window includes 'Close' and 'Apply' buttons. Blue lines connect the 'Apply' button and the 'Max Output Power (Wpeak)' field to explanatory text boxes below.

The frequency of the **X-Over's** high-pass filter (HPF) is used to determine attack and release times that will preserve the integrity of lower frequencies with longer wavelengths. If the HPF is set to a higher frequency, the calculator will permit quicker attack and release settings. Please note that the calculator also considers the HPF frequency even when the filter is disabled.

Enter the impedance and maximum peak wattage of your loudspeaker. This information is typically found on the rear of the speaker or in a datasheet. Click **Apply** to implement the calculated values.



USER / Speaker Preset Library

The CloudPower™ provides a feature to load pre-made processing **presets** onto each channel, specifically designed to apply speaker-specific settings. These presets can be created using the speaker preset creator or can be supplied by speaker manufacturers.

It's important to note that a **speaker preset** doesn't alter the parameters of the USER processing; instead, it introduces an entirely new layer of processing on top of the existing USER and GROUP processing. You can manage and load these presets as follows:

Select the channel where you wish to load a preset.

Select the **Speaker** menu

Currently loaded preset on the selected channel.

Active preset between > <

Adding presets to the library

By default, the library consists only of the **Factory Folder**, containing a blank preset. You can upload new presets to the library either in bundles or as individual files.

To upload a **bundle** of presets: (.cpspkrfr extension)

- **Create** and **name** a new **folder** and **select** it.
- Press **Upload Folder** and select the .cpspkrfr file from your computer.
- Press **Upload in folder** to confirm.

To upload a **single** preset file (.cpspkr extension)

- Select a user folder.
- Press **Upload Preset** and select the .cpspkr file from your computer.
- Press **Upload** to confirm.

Folder can be renamed with the **Rename** button. Both folders and individual presets can be removed with the **Delete Folder** and **Delete Preset** buttons.

Loading a preset onto a channel

- Make sure to have the correct channel selected.
- Select the desired preset from a folder.
- Press **Load**.

A popup will ask for confirmation and offer to replace the channel label with the preset name.

- Click **Load** to confirm and apply the preset. The name of the preset should be shown in the USER menu header between *Limiter* and *Speaker*. In the library, the active preset is highlighted between angle brackets: >name<

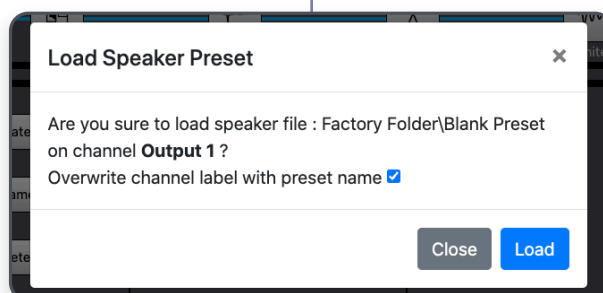

Sidebar Menu | Network Devices

The sidebar menu grants access to the network devices and the GROUP processing.

Click the **Sidebar** button to expand it



The sidebar displays the currently connected device as the "Local device," and it lists other CloudPower™ amplifiers in the network as "Network devices."



When you select another CloudPower™ amplifier within the network, its USER interface will be displayed, allowing you to operate it.

Important: To access other devices through "Network devices" in the sidebar menu, it's necessary that all CloudPower™ devices on the network use **the same login credentials**.

Sidebar Features

Click to open the GROUPS menu.

The amplifier's custom **name** and **IP** address.

Click the info icon to display a popup window containing the amplifier **details** and its **status**.

The **model** is also displayed in the CP Icon.

Small versions of the **output meters** which turn red when a limiter is active, providing an overview of the output activity in the network.

Click **refresh** to update the device list.

Previous active devices that are currently offline are shown with a red outline, indicating that they were previously connected but a connection cannot be established. This could suggest that the amplifier has been turned off or there may be network issues. If a device was intentionally removed from the network but still appears, performing a reboot of the amplifier will clear the list.

Status of cp716testlab

```

Cloud device name : cp716testlab
IP address : 192.168.2.116
MAC address : 02:81:D7:FD:16:3E
Model : CP0716
Serial number : CE16230003
Device alive : OK
Websocket status : OK

```



GROUPS

Groups offer robust control over all the channels within a system. Amplifier channels can be linked to several groups, with each channel potentially belonging to up to six distinct groups. Modifying group settings will impact all amplifier channels within the network assigned to that specific group.

Employing multiple groups can be useful in logically segmenting a expansive system. For instance, amplifier channels responsible for a restaurant area can be grouped together to establish a restaurant sub-master. A master group can also be formed, granting access to system-wide EQ and level adjustments, enabling instantaneous modifications across all amplifier channels in the network.



Edit Groups

The first thing you want to do is give your groups a custom name. This is done in the **Edit Group** menu.

With the sidebar expanded, click on **GROUPS** to open the menu.

Click on **Edit Groups** to access the page where you can customize the names of the six groups.

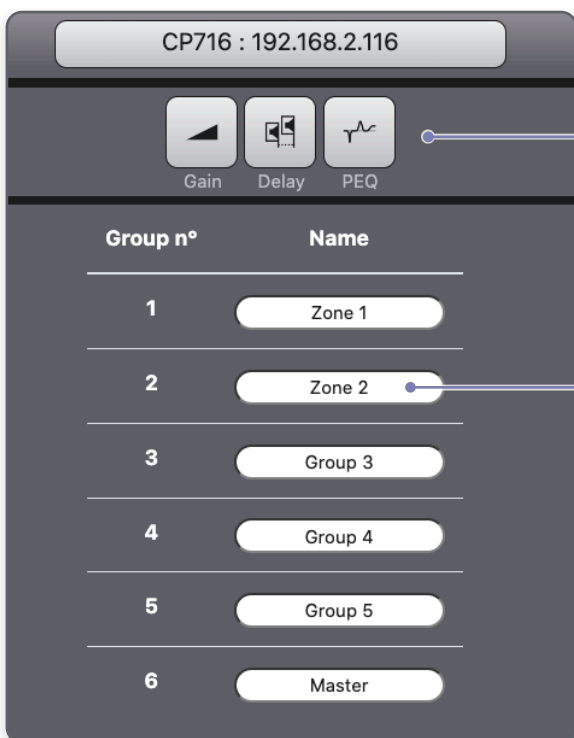
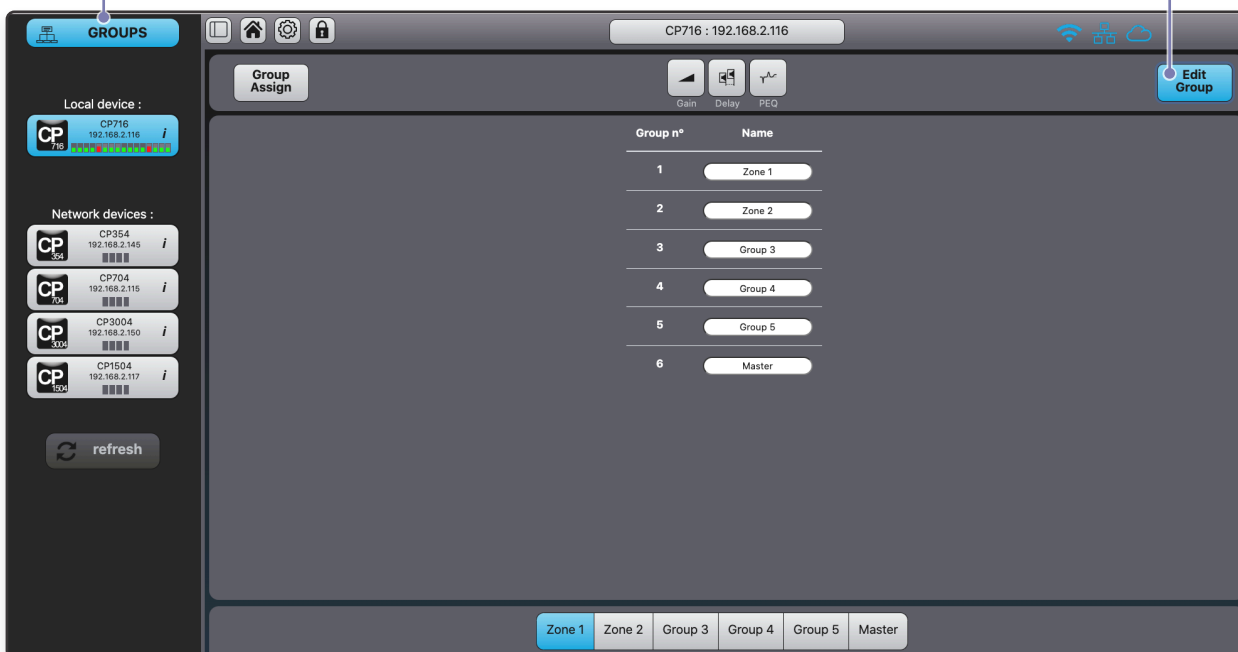

The three GROUP processing menus

Enter custom **names** for your groups.

When controlling multiple devices from the same web interface, please ensure all devices have the same login credentials.



Assign Groups

Next, you'll want to assign the channels to one or multiple groups. You can easily do this using the routing matrix in the **Group Assign** menu.

Click on **Assign Groups** to show the routing matrix.

Click on the amplifier **headers** to show their channels in the matrix. The selected amplifier's header is **blue**.

The screenshot shows the 'Group Assign' interface. On the left, there is a list of amplifiers: CP716, CP354 (selected), and CP704. Each amplifier has a list of outputs (Output A-P for CP716, Output Name 1-4 for CP354, and Output 1 for CP704). The selected amplifier (CP354) is highlighted in blue. The main area shows a routing matrix for CP354 with IP 192.168.2.145. The matrix has columns for Zone 1, Zone 2, Group 3, Group 4, Group 5, and Master, and rows for Output Name 1 through 4. Green buttons indicate assignments. A 'Dot' button is visible at the bottom of the matrix. The interface also includes a 'Group Assign' button, an 'Edit Group' button, and a status bar at the bottom with buttons for Zone 1, Zone 2, Group 3, Group 4, Group 5, and Master.

Assign the amplifier's channels to the groups by pressing the buttons in the matrix. Green buttons indicate assignment.

Clear all assignments for the selected amplifier with the **Dot** button.

Toggle the **Arrow** buttons to **expand or collapse** the submenus. The two arrows at the top allow you to expand and collapse **all** submenus.

The grey and green **dots** offer a clear **overview** of the assignments.

When controlling multiple devices from the same web interface, please ensure all devices have the same login credentials.

GROUP / Gain

You are now ready to start using the GROUP processing. First in the chain is the **GROUP Gain**. Be sure to select the correct group at the bottom of the screen first.

Click **Gain** to access the gain controls.

Click the phase button to flip the **Polarty** of every channel in the group with 180°.
Click **Mute** to silence every channel in the group.

Gain Fader
Relatively add or subtract gain from every channel assigned to this group. The range is between -80 and +15 dB.

Select which group to operate.

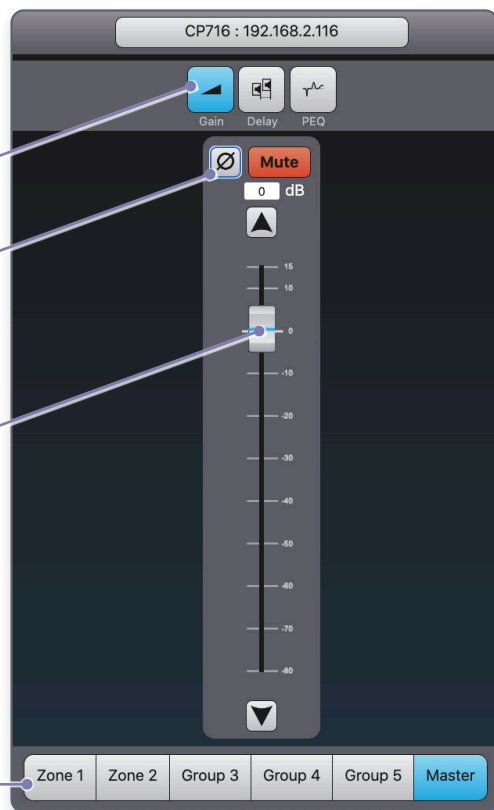

GROUP / Delay

In the delay window you can adjust the **GROUP Delay**.

Click **Delay** to access the delay controls.
Enable toggles the delay on or off.

Delay Fader
Relatively add up to 250 ms of delay to every channel of this group.
Note: the 250 ms is shared with the USER delay time.

Select which group to operate.

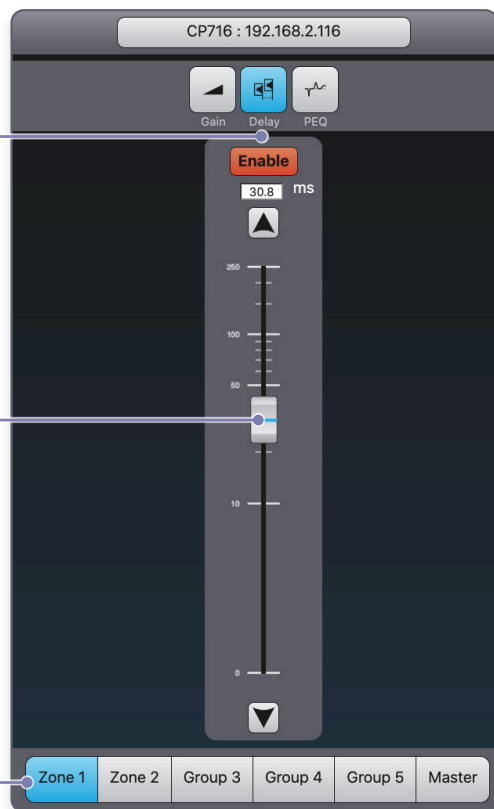



GROUP / PEQ

The **GROUP PEQ** enables you to apply an additional layer of EQ processing to all the channels assigned to the group. If a single channel is assigned to multiple groups, it will undergo processing from all the PEQs of those groups.

The GROUP PEQ works exactly the same way as the USER PEQ.

For a detailed explanation, refer to the corresponding section in the manual on page 38.

Click **PEQ** to access the equalizer.

The screenshot shows the PEQ configuration interface. At the top, there are navigation buttons for 'Gain', 'Delay', and 'PEQ'. Below the graph, there is a row of buttons for selecting different PEQs (PEQ 1 through PEQ 12). The filter bank table below shows the following settings:

Band	Band Ena	Filter type	Freq. (Hz)	Gain (dB)	Q	Band	Band Ena	Filter type	Freq. (Hz)	Gain (dB)	Q
1	<input type="checkbox"/>	Bell-Sym	50	0	2,5	7	<input type="checkbox"/>	Bell-Sym	1000	0	2,5
2	<input checked="" type="checkbox"/>	High-Pass VariQ 12dB/oct	80	0	1,5	8	<input type="checkbox"/>	Bell-Sym	2000	0	2,5
3	<input type="checkbox"/>	Bell-Sym	200	0	2,5	9	<input type="checkbox"/>	Bell-Sym	3000	0	2,5
4	<input type="checkbox"/>	Bell-Sym	300	0	2,5	10	<input type="checkbox"/>	Bell-Sym	4000	0	2,5
5	<input type="checkbox"/>	Bell-Sym	400	0	2,5	11	<input checked="" type="checkbox"/>	Bell-Sym	5000	6	1
6	<input checked="" type="checkbox"/>	Bell-ASym	660	-6	2,5	12	<input type="checkbox"/>	Bell-Sym	10000	0	2,5

At the bottom of the interface, there are buttons for 'Zone 1', 'Zone 2', 'Group 3', 'Group 4', 'Group 5', and 'Master'. The 'Group 4' button is highlighted, indicating it is the selected group for the PEQ.

Select which group's PEQ to operate.

When controlling multiple devices from the same web interface, please ensure all devices have the same login credentials.



Web UI / Settings Menu

To access the CloudPower™ settings menu, click on the gear icon located in the interface's header. This will open a new page with various setting tabs.



Click on the **Gear** icon in the interface's header to open the **settings** menu.



Web UI / Settings / Device Name

In the **Device Name** tab, you have the option to assign a custom name to your amplifier.

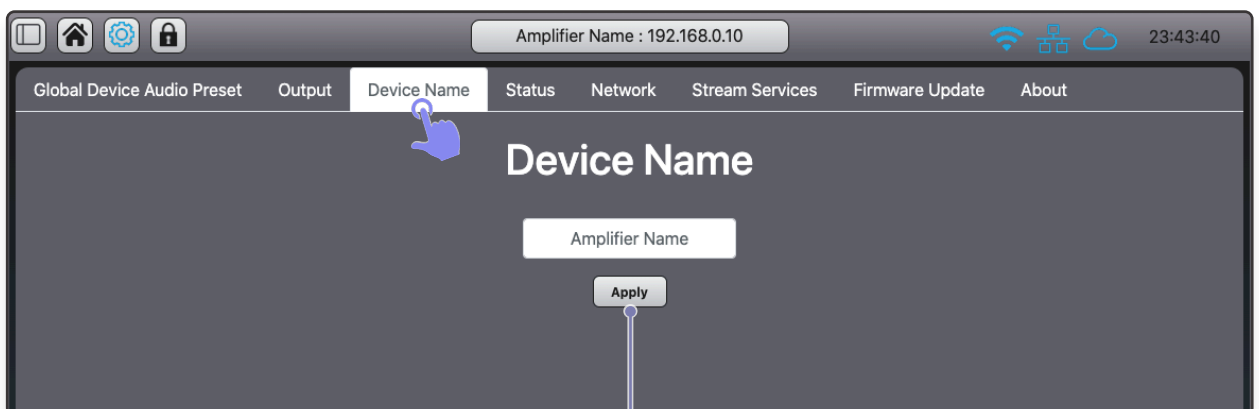

Enter a custom name for this amplifier and click **Apply** to confirm. The custom name will be displayed in the interface header alongside its IP address, in the sidebar menu devices list, and on the group routing page.



Web UI / Settings / Global Presets Library

Global Preset files contains all audio DSP settings of every channels of the amplifier, including: USER, GROUP and SPEAKER PRESET parameters.

They do not contain any other settings found in the settings menu such as: Output operation and configuration (100V HPF, bridge mode), network settings and streaming account details.



Saving and Loading Presets

By default, the library includes only the **Default Folder**, which contains a **Default Preset** that resets all parameters when loaded.

To **save** the current settings as a new preset:

- **Create** and **name** a new user folder.
- With a user folder selected, press **Save As Preset**.
- In the popup window, enter a **name** for the preset and press **Save As Preset** to confirm.

To **overwrite** an existing preset:

- Select the preset and press **Save Preset**.
- In the popup window, press **Save Preset** to confirm.

To **Load** a global preset:

- Select the preset and press **Load Preset**.
- In the popup window, press **Load Preset** to confirm.

Uploading and Downloading Presets

The user-made global presets can be downloaded and uploaded.

These files have a .cpglob extension.

To **Download** a global preset:

- Select it and press **Download Preset**.

To **Upload** a global preset:

- Select the folder where you want to place it.
- Press **Upload Preset**.
- In the popup window, localise the .cpglob file on your device and press **Upload**.

Folders and individual presets can be removed with the **Delete** buttons.

CAUTION

Exercise caution when loading user-made global presets, as they may contain high gain settings that can result in sudden loud volume output, potentially causing speaker or hearing damage.

When loading the **default** global preset, the amplifier will **mute** all outputs to prevent this.

 **Web UI / Settings / Output Mode**

In the output window, you have the option to configure channel **bridging** for both A-B (1-2) and C-D (3-4) on the 4-channel CP354 and CP704 models. When the bridge mode is enabled, refer to the diagram below for the correct wiring configuration of the output terminals.

Additionally, there's a **70/100V mode** available per channel. This mode applies a **100Hz 12dB/octave High-Pass Filter** at the final processing stage. The HPF is designed to prevent distortion and potential damage to transformers. Apart from the HPF, this mode does not affect the amplifier's operation.

Keep in mind that any adjustments made within the Output window will not be stored in the global presets.

Press **Enable** to turn on the 70/100V 100Hz 12dB/octave HPF.

Press **Enable** to **bridge** adjacent channels on the 4-channel models.

The **Output Wiring** diagram illustrates how to connect the terminals. Bridged speakers are connected between the positive poles of both amplifier channels, the negative poles are not used.

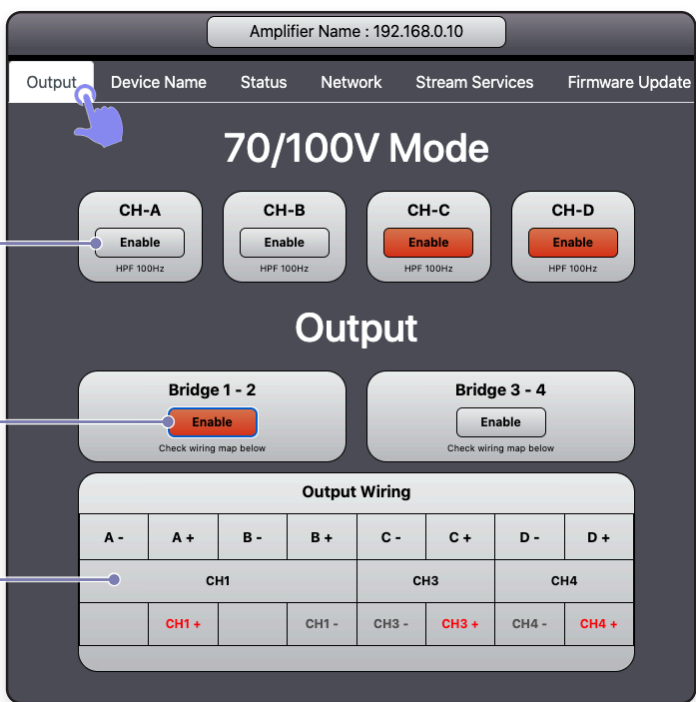

Please note:
Bridging is only available for the following models:
- CP354 / 354D
- CP704 / 704D



When **bridged**, the channel headers of the two channels will merge. Please note that only channels A and C settings are retained after switching to bridge mode. The gain and delay faders of the first channel (A and C) will control the bridged channel.



Web UI / Settings / Network

In the network tab, you can access all network-related settings, including the device's LAN, hotspot and cloud settings, and login credentials.

LAN

The LAN section gives control over the amplifiers IP configuration.

The screenshot shows the 'Network' tab selected. Under 'LAN', the IP address is 192.168.0.10, the Mask is 255.255.255.0, and the Gateway is 192.168.0.1. The 'DHCP' checkbox is checked. An 'Apply' button is at the bottom.

IP

In DHCP mode, an IP address will be automatically displayed when a connection is established with the router.

In static mode, you need to manually enter an IP address.

Subnet Mask

For DHCP mode, the subnet will also be automatically displayed when the connection is established.

In static mode, you must manually enter the subnet mask.

Gateway

For DHCP mode, the gateway will also be automatically filled in.

In static mode, provide the router's address, typically ending with "1".

Connect via a router

Connect the CloudPower™ device(s) CONTROL connector together with a PC to a router. The use of a router is mandatory in DHCP mode to obtain IP addresses. After a connection is established with the router, the CloudPower™ device will receive an IP address that will be displayed in the network menu. Enter this address in your device's browser, and the IntelliCloud software will open on your device.

Hotspot

Each CloudPower™ amplifier features a Hotspot, enabling users to control the amplifier using any mobile device (smartphone, tablet, or laptop) without needing access to the local network to which the amplifier is connected through its CONTROL port. The CloudPower™ software is web-based, eliminating the need for software installation. Its primary purpose is to ensure accessibility to the web interface when the LAN cannot be accessed or is experiencing issues.

The screenshot shows the 'HOTSPOT' section. The SSID is AMP_XXXX and the Password is 12345678. The 'ENABLE' checkbox is checked. An 'Apply' button is at the bottom.

Activate the **Hotspot** by ticking the checkbox. Then search for the **SSID** name within your device's available Wi-Fi networks. Connect to the hotspot and enter IP address **172.24.0.1** in your browser's URL. This will automatically open the IntelliCloud web interface on your device.

SSID is the name of the generated hotspot, which you can find in your list of available Wi-Fi networks.

The **Password** will be prompted by your device when attempting to connect to the hotspot.

After making changes to either the name or password, click the **Apply**. Both can also be viewed from the front panel.

Please note that the web interface will also prompt you for a login and password. By default, both are set to "**admin**" and can be altered in the credentials section of this menu.

Cloud Connect | Remote Access

Every CloudPower™ amplifier is equipped with a Cloud feature. This feature enables users to remotely manage the amplifier via the internet. To enable this, the CONTROL port (on the rear side of the amplifier) must be connected to a router with an internet connection. Using a secure connection, users can operate the amplifier and all other CloudPower™ devices within the same network from anywhere in the world.

Enter a cloud name for your device enable, check **ENABLE** and click **Apply**.

The name can only consist of alphanumeric characters and must be minimum 10 characters in length.

When assigning cloud names to your amplifiers, make sure to create unique names by including detailed descriptions or codes. This ensures that no two CloudPower™ amplifiers in the world share the same cloud name. For example: "AmpCompanyLocationA1234"

With the Cloud feature enabled, open a web browser connected to the internet and enter the following URL:

http://cloudname.apexconnect.me

This will enable you to connect to the amplifier, which will then prompt you for the login and password. By default, both are set to "admin".

Note: You will be prompted for the login credentials twice — first by the relay server, and then by the amplifier's server. Both sets of credentials are the same.

Login Credentials

Here, you can modify the login credentials that are required when accessing the web interface.

Alter the login and password, then click **Apply** to confirm the changes.

When controlling multiple devices from the same web interface, please ensure all devices have the same login credentials.



Web UI / Settings / Stream Services

CloudPower™ is the first amplifier in its class with an integrated audio source and streaming capability, allowing easy streaming of background music from devices running apps such as Spotify or AirPlay.

Please note it is not possible to stream Spotify and Airplay simultaneously.

The output from the streaming sources will be audible through the **ST L** and **ST R** faders located in the **Mixer** of the **USER** section.

In a **stereo** setup, one channel will carry ST L, while an other channel will carry ST R.

In a **mono** setup, both ST L and ST R signals need to be combined.



Spotify

If enabled, the CloudPower™ will function as a playback device for Spotify applications on the same network. If premium account credentials are supplied, only that account will be able to connect with the amplifier, and playback can be controlled from multiple locations.

Name	Status	Network	Stream Services
Stream Services			
SPOTIFY :			
Spotify name			
CloudPower			
Email address (optional)			
accountname@email.com			
Password (optional)			
.....			
<input checked="" type="checkbox"/> ENABLE			
Apply			

Spotify name

This is the name that will be displayed in the playback devices of your Spotify interface.

Email Address & Password

Optionally, you can choose to provide the credentials of your premium Spotify account. This will enable you to play music from various locations and restrict access to non-public users.

Mark the **ENABLE** checkbox and then click on **Apply** to confirm the changes.

Open your **Spotify** application.

In your list of **playback devices**, you will find the custom CloudPower name available for selection.

Upon connection, the volume will be initially set to around 10% to prevent sudden loudness. Adjust the fader to achieve a suitable volume level.

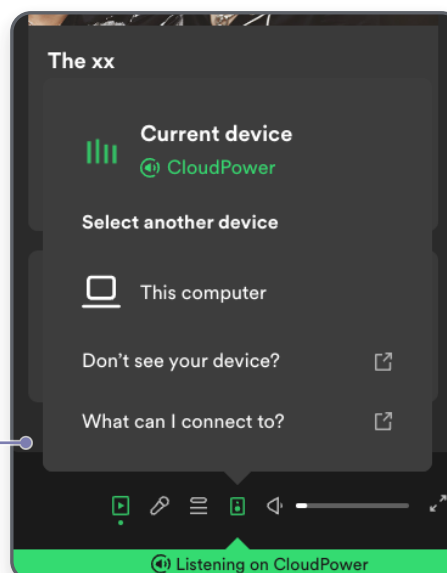

Apple Airplay

AirPlay streaming can be enabled and customized. Ensure that your mobile device is connected to the same network as your CloudPower™ device.

AIRPLAY :

Airplay name

CloudPowerAir

Password (optional)

.....

ENABLE

Airplay name

This is the name that will be displayed on your devices.

Password

Optionally, you can set a password to prevent unauthorized individuals from connecting to the CloudPower.

Check **ENABLE** and then click **Apply**.

The CloudPower should now appear among the selectable devices that support AirPlay.

When you connect, the volume will initially be set to approximately 30% to avoid sudden loudness. Adjust the volume to reach a suitable level.

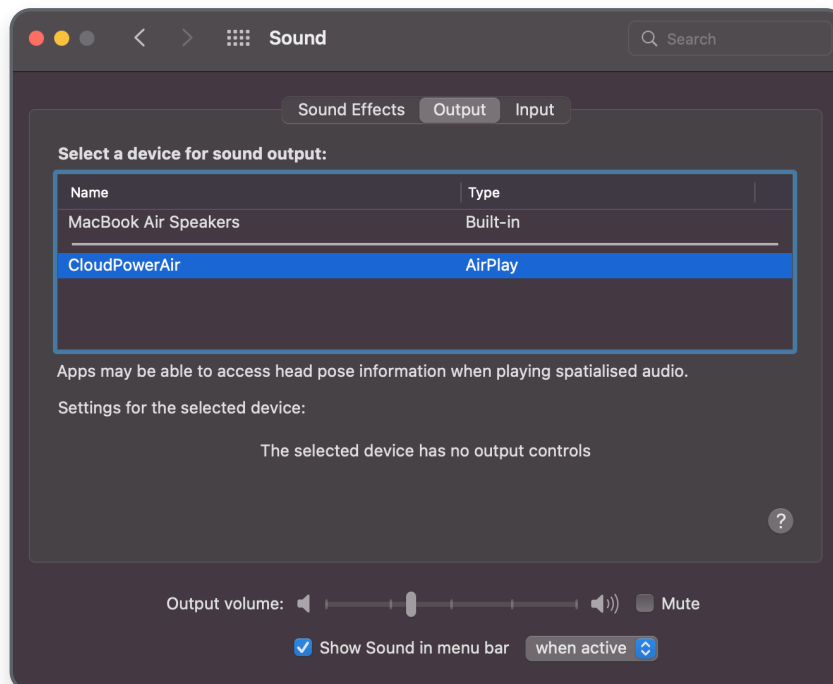



Web UI / Settings / Firmware Update

Updating the firmware can conveniently be done through the web interface. Firmware updates will be available when new features are implemented. Please note that you need to restart the amplifier manually to complete the process.



To update the firmware:

1. Download the latest firmware **zip file** from www.apex-audio.be/downloads
2. Select the file using the **Select File** button.
3. Click **Update Now**.
4. The front panel OLED display will show the **updating progress**. Do not turn the power off during the update. Once completed, the message **"Please Restart"** will appear on the display.
5. Turn the amplifier off and back on to complete the process.



Web UI / Settings / About

Lastly, the **About** menu will present the device's model, serial number, MAC address, and current firmware version. You can also download the latest manual from this section.

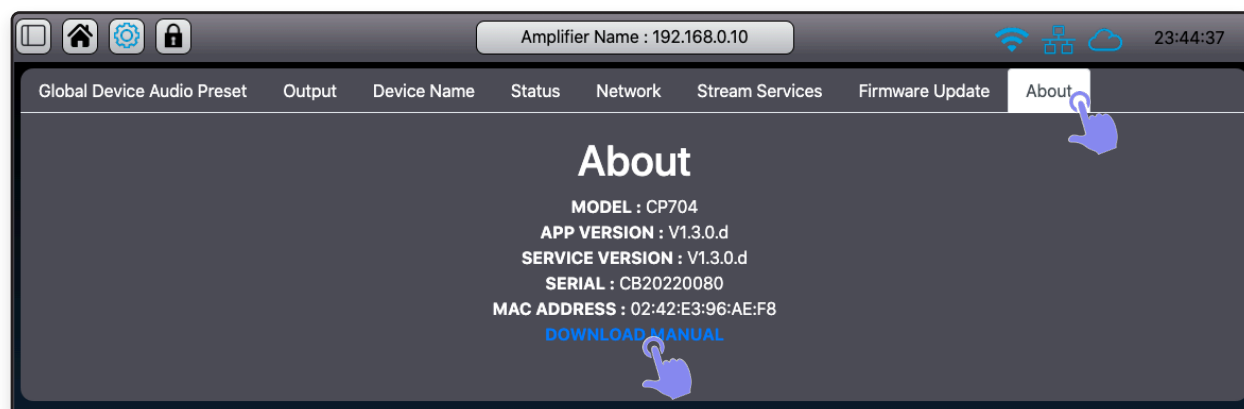



Speaker Preset Creator

The web interface hosts its own **Preset Creator** software for designing speaker presets. To access this feature, simply add `"/preset.html"` after the IP address in the URL.

For instance: `http://192.168.0.10/preset.html`

Access to this preset creator page can be secured with an OEM code if necessary.

The control interface operates similarly to the USER and GROUP interfaces, with a few exceptions.

Mute will mute or unmute the amplifier's channel output. This status is not saved within the preset.

Select is used to select the channel to which the connected speaker is allocated while designing a preset.

When a modification is made within any of the submenus, the **ON/OFF** led's will turn to a green **ON** status indicating processing is active. You can remove the processing on that element using the **CLEAR** button.

Access and **Manage** the preset library.

Added capability to incorporate a **FIR filter** with 768 taps.

To activate the filter:

- Press the filter icon.
- Locate the file on your computer.
- Confirm to upload.
- Toggle the latch switch to the on position.

The X-Over's **Enable Overwrite** feature permits users to modify the crossover frequency of a protected speaker preset using the USER controls.

The frequency specified here becomes the minimum for the HPF or the maximum for the LPF, but it can be adjusted in the opposite direction to attenuate frequencies.

Usage example: The top speaker preset can operate with various subwoofers. Depending on the specific subwoofer in use, adjustments can be made to the top speaker's HPF settings.

The **Delay** function is designed for phase alignment and can be adjusted up to 30 milliseconds.

The **Gain** fader offers additional information regarding the output voltage.

The **Limiter** functions in the same manner as with the user controls.

Speaker Preset Library

After designing a preset, it can be stored in the **speaker preset library** and optionally protected with an OEM code. These presets can be included with the amplifier upon shipping or made available through a speaker manufacturer's website.

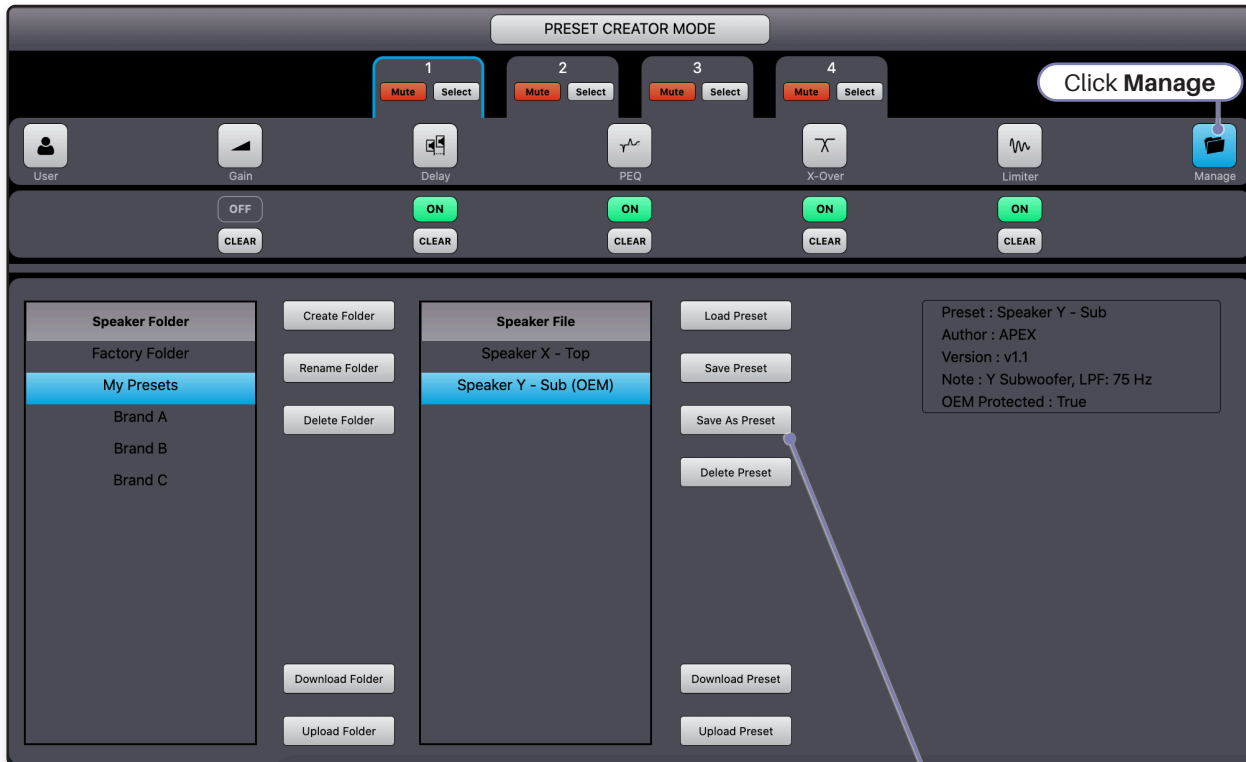

New speaker presets can be saved in **User Folders** using the **Save As Preset** button.

Each preset's name must be unique within the same folder. Trying to use **Save As Preset** with a name that's already in the folder won't work.

To **overwrite** a preset, select it and then press **Save Preset**.

When **saving as** presets, you can add extra information like author, version, and notes. You can also choose to lock presets using an OEM code.

The **OEM locked** presets are specific to amplifiers sharing the same OEM code and cannot be used on amplifiers without the same code.

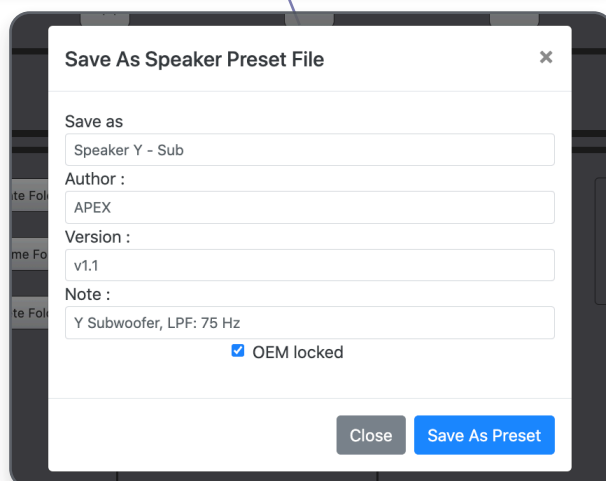

If **multiple** presets are created and stored together in one folder, they can be **downloaded** as a **bundle** using the **.cpspkrf** extension.

- **Select** the folder and press **Download Folder**.

To download **individual** presets with the **.cpspkr** extension,

- **Select** the preset and press **Download Preset**.

Folders and individual presets can be removed with the **Delete Folder** and **Delete Preset** buttons.

Upload presets as bundles (**.cpspkrf** extension)

- **Create, name** and **select** a new user folder.
- Press **Upload Folder**.
- In the popup window, localise the **.cpspkrf** file on your device and press **Upload in folder**.

Upload individual presets (**.cpspkr** extension)

- **Select** a user folder.
- Press **Upload Preset**.
- In the popup window, localise the **.cpspkr** file on your device and press **Upload**.



OEM Configuration

To secure the speaker creator and avoid incorrect presets from being loaded, an OEM code can be set in the OEM Config window. To reach this page, add "/oem.html" after the IP address in the URL.

For example: <http://192.168.0.10/oem.html>

CloudPower OEM config

IP address :
192.168.0.10

MAC address :
02:42:E3:96:AE:F8

Model :
CP704

Serial number :
CB20220080

OEM Status :
Enable

OEM Label :
APEX1

To **set up** an OEM configuration:

- Click **Set OEM Config**
- Enter an **OEM Label** and **OEM Code** and **Submit**

To **remove** the OEM configuration:

- Click **Delete OEM Config**
- Enter the **OEM Code** and click **Remove**

Set new OEM settings

OEM Label (min 5 chars):
APEX1

OEM Code (10 chars):
0123456789

OEM code will be needed to update config later !

Remove OEM settings

Previous OEM Code (10 chars):
0123456789

Don't forget to remove OEM presets !

Speaker Presets created under the OEM locked checkbox are now linked to this OEM code. They cannot be uploaded or downloaded to an amplifier unless the same OEM code is set up on that amplifier.

Speaker Preset Configurator

OEM code

When an OEM mode is set up, you will need the OEM code to be able to access the **Speaker Preset Creator**.

Application Examples

Bar

In this bar example, the two rooms are each equipped with their own speaker system comprising of a bar zone with ceiling mount loudspeakers and a dancing area with a stereo set of full range loudspeakers. Each of the systems is able to play any of the selected analog sources. The level can be easily adjusted via the front panel control or via an optional external computer.

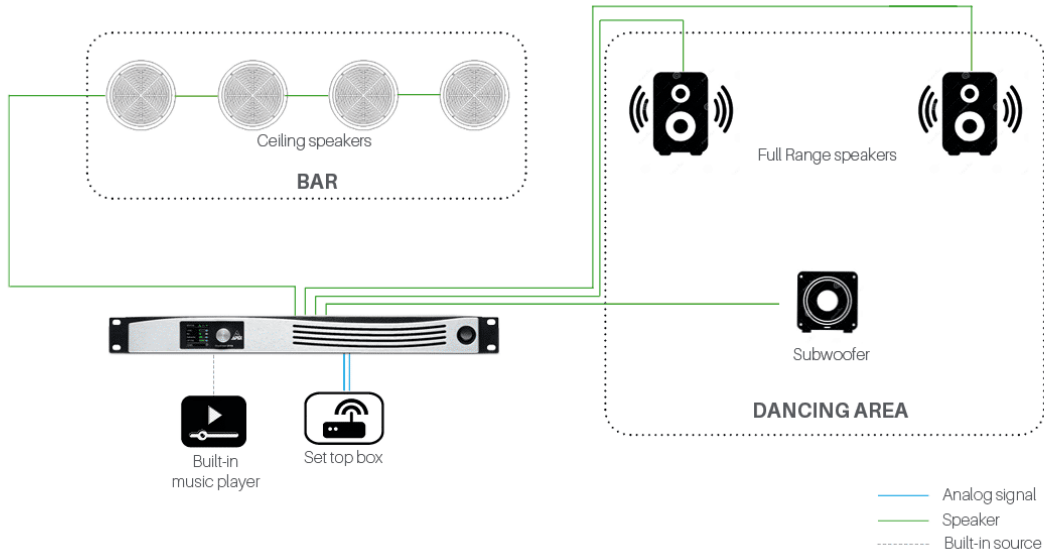

Museum

In this museum example, all the zones are equipped with their own speaker and amplifier system. The CloudPower devices are connected to a central switch with standard network cabling. Settings can be done with either the central local computer or from a remote location over the internet. Fine tuning can be done with any mobile device connected to an amp's hotspot.

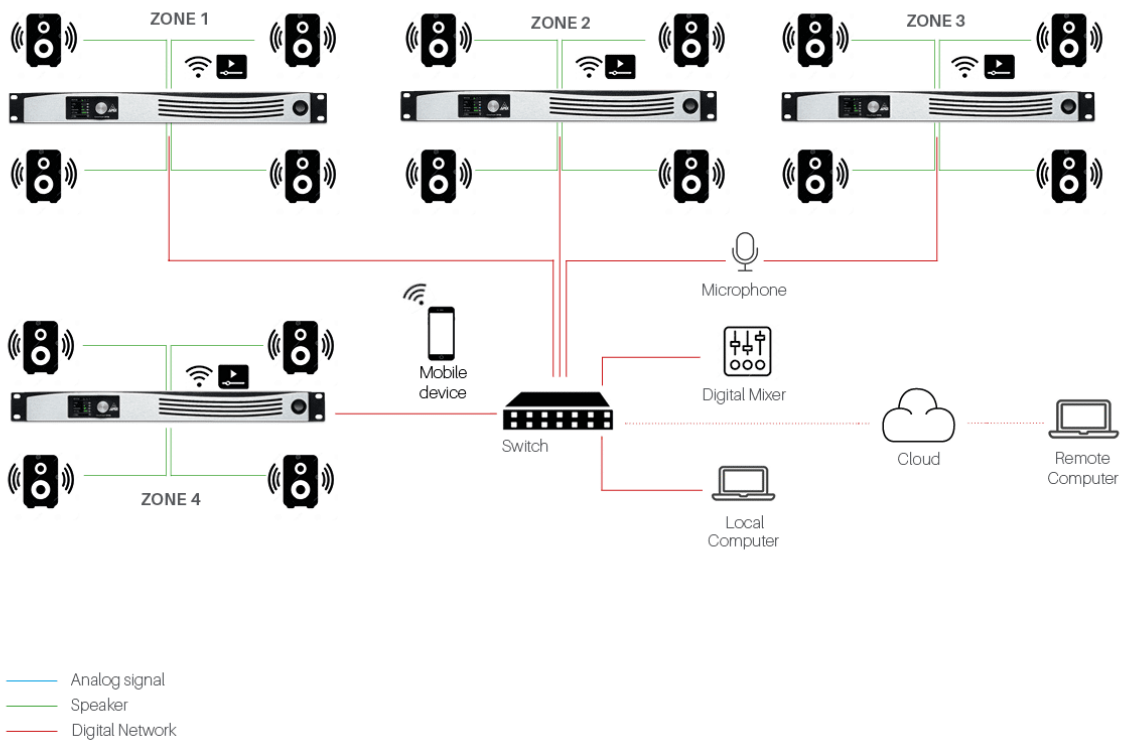

Restaurant with Karaoke Area

In this restaurant example, the four rooms are each equipped with their own speaker system comprising of a bar zone with full range loudspeakers, a Karaoke area with a small PA system, a restaurant with ceiling loudspeakers and the rest rooms, also equipped with ceiling loudspeakers. Each of the systems is able to play any of the selected analog or digital sources. The IntelliWare web based software has a powerful group function, so changes for every zone can be made from the central computer.

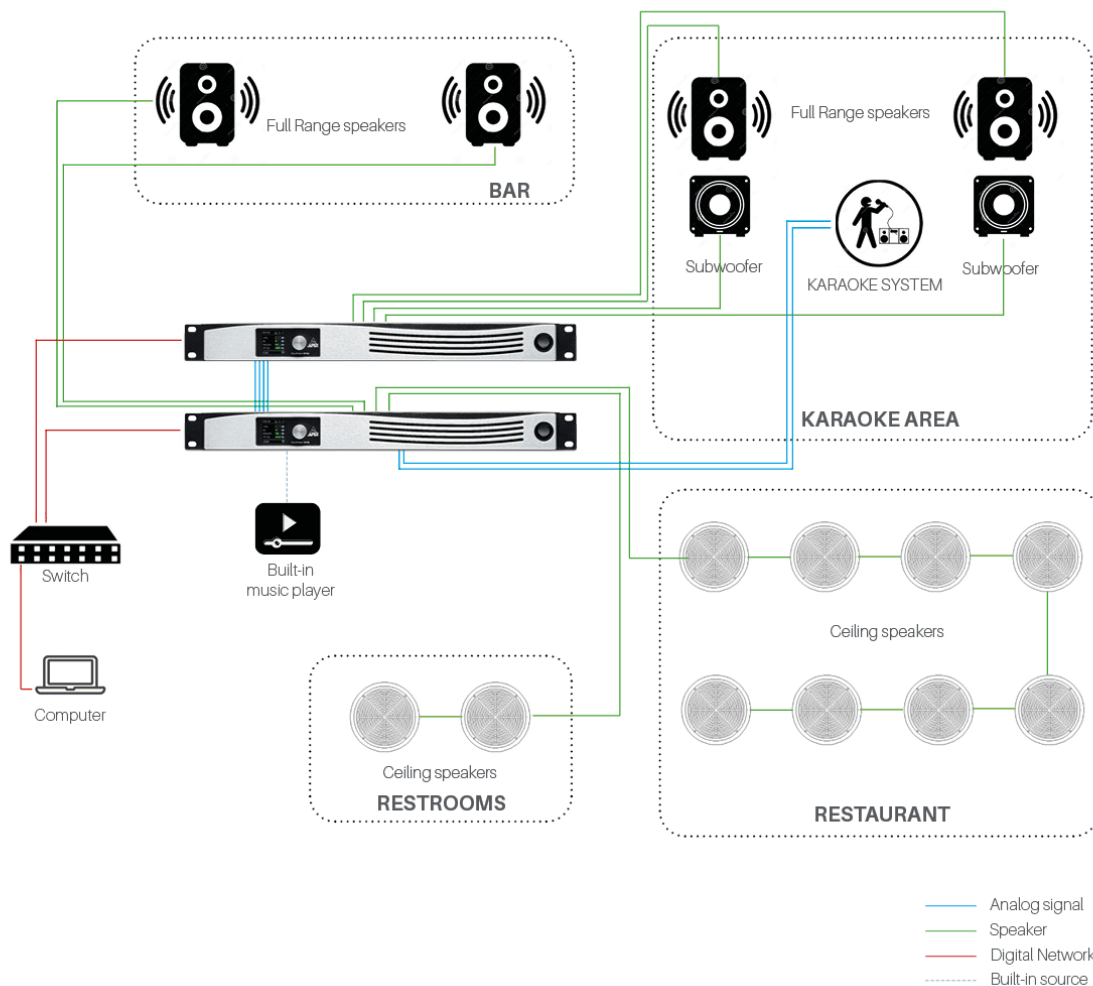

Specifications 4 Channel Models



Operating conditions

Temperature	0° to 50° C, 10 to 60 % non-condensing
Storage temperature	-20° to 70° C
Safety / Compliance	CE Certificate

Amplification and power supply

Amplification class	Class D GlidePath technology
Power supply model	Universal switch mode power supplies with active PFC
Power Factor	> 0,9 above 1/2 P
Mains Rating	100 - 240V @ 50-60 Hz
Operating Voltage	90 - 260V
AC Mains connector	IEC C20 Inlet (20 A max) , CP1504 -3004: Powercon 32A

MAX AVERAGE POWER CONSUMPTION (1/8)	CP354 / CP354D	CP704 / CP704D	CP1504 / CP1504D	CP3004 / CP3004D
Watts (W)	700	700	1400	2800
Amps @ 230V	3.1	3.1	6.1	12.2
Amps @ 120V	5.9	5.9	11.7	23.3

Audio Specifications

Frequency response	1Hz - 22kHz
Distortion THD+N	0,05% @ P/2 , 20Hz- 20 kHz, 22 kHz BW
Noise level (20 Hz - 20 kHz @ 8 ohm)	< 100 uV (A)
Latency	1 mS
Phase response	±10 deg 3 Hz - 20 kHz
S/N (20 Hz - 20 kHz @ 8 ohm)	CP354 - 704: 115 dB (A), CP1504 - 30004: 118 dB (A)
Damping factor	4000@8ohm <1Khz
Input sensitivity	Settable in speaker preset. By default analog in to amplifier output = 26dB

DSP

Digital Signal Processor	64 bit FIXED POINT
I/O Routing	Flexible routing matrix

Dante Audio Networking

Dante card prefitted in CP354D / CP704D / CP1504D / CP3004D. Retrofit option card available for CP354 / CP704 / CP1504 / CP3004
4 Dante input channels with adjustable gain in the amplifier channel mixer
Supports 48/96kHz Dante networks
Two Gigabit network ports for the Dante network, configurable in switched or redundant mode
Supports AES67
Locate function (from Dante Controller, locate mode can be switched on to make the network port LEDs flash to locate them)



User processing functions per channel

Gain:	-80 to +15dB, 0,1dB steps
Polarity:	Normal / inverted
Delay:	0 to 250 ms (Shared between User and Group settings)
PEQ:	12 x PEQ. Each PEQ can be set to a choice of 16 filter types (1)
HP/LP filters:	Bessel , Butterworth and Linkwitz Riley with slopes from 6 to 48 dB/oct
Limiter:	Peak voltage, RMS voltage

Group processing functions

Six global processing group overlays which can link any amplifier channel in the network

Gain:	-80 to +15dB, 0,1dB steps
Polarity:	Normal / inverted
Delay:	0 to 250 ms (Shared between User and Group settings)
PEQ:	12 x PEQ. Each PEQ can be set to a choice of 16 filter types (1)

Speaker processing functions

Gain:	-80 to +15dB, 0,1dB steps
Polarity:	Normal / inverted
Delay:	0 to 250 ms (Shared between User and Group settings)
PEQ:	12 x PEQ. Each PEQ can be set to a choice of 16 filter types (1)
HP/LP filters:	Bessel , Butterworth and Linkwitz Riley with slopes from 6 to 48 dB/oct
Limiter:	Peak voltage, RMS voltage
FIR filters:	768 taps per channel
(1) Filter types:	Bell-Sym,Bell-Asym, Notch, Low-Shelf 6dB or 12dB, High-Shelf 6dB or 12dB All-Pass 90° or 180°, High-Pass 6dB, or 12dB, High-Pass Vari-Q 12dB, Low-Pass 6dB or 12dB, Low-Pass Vari-Q 12dB, Band-Pass

Circuit protection

Mains and power supply	Under, over voltage, over current protection
Power outputs	DC, Over-temp, Over-current limiter, VHF
Cooling	Cooling fans with signal control speed

Inputs

Analog	4 balanced analog line inputs 4x 3-pin Phoenix
A/D conversion	32 bit
Input impedance	10k Ohm
Max. Input level	21 dBu
Digital	4 input Dante (integral in CP354D / CP704D / CP1504D / CP3004D. Retrofit module available for CP354 / CP704 / CP1504 / CP3004)
Internal Streaming source	Two channel internal streaming source supporting Spotify and AirPlay

Remote control and monitoring

Network connection	Single port Ethernet interface
Apex remote control software	Web UI with built in web-server

Front panel indicators

Daylight viewable colour OLED display	Real time level , limit and fault indicators
---------------------------------------	----------------------------------------------



Amplifier model	CP354 / 354D	CP704 / 704D	CP1504 / 1504D	CP3004 / 3004D
Total burst power (all channels driven)	1400	2800	6000	12000
2 ohms (with correct limiter setup)	350	700	1500	3000
4 ohms	350	700	1500	3000
8 ohms	350	500	1500	2000
16 ohms	250	250	1000	1000
Hi-Z 70V	280	280	1500	1500
Hi-Z 100V	140	140	1500	2500

Max Output Power bridged mode				
4 ohms	700	1400	NA	NA
8 ohms	700	1400	NA	NA
16 ohms	700	1000	NA	NA

Power and Thermal 115V				
Idle Power	30W	30W	60W	120W
Idle Current Draw	0.3A	0.3A	0.6A	1.2A
Idle Thermal loss	102 BTU/h	102 BTU/h	204 BTU/h	408 BTU/h
1/8 Power @ 4 Ohm Power	185W	375W	800W	1600W
1/8 Power @ 4 Ohm Current Draw	1.6A	3.3A	7A	14A
1/8 Power @ 4 Ohm Thermal loss	341 BTU/h	682 BTU/h	1364 BTU/h	2729 BTU/h

Power and Thermal 230V				
Idle Power	30W	30W	60W	120W
Idle Current Draw	0.15A	0.15A	0.3A	0.6A
Idle Thermal loss	102 BTU/h	102 BTU/h	204 BTU/h	408 BTU/h
1/8 Power @ 4 Ohm Power	185W	375W	800W	1600W
1/8 Power @ 4 Ohm Current Draw	0.8A	1.65A	3.5A	7A
1/8 Power @ 4 Ohm Thermal loss	320 BTU/h	640 BTU/h	1280 BTU/h	2560 BTU/h

Physical				
Unit Dimensions	483 x 44.5 x 358 mm	483 x 44.5 x 358 mm	483 x 44.5 x 458 mm	483 x 44.5 x 458 mm
Shipping Dimensions	610 x 150 x 420 mm	610 x 150 x 420 mm	610 x 150 x 610 mm	610 x 150 x 610 mm
Unit Weight	5 kg - 11 Lbs	6 Kg - 13 Lbs	8 kg - 17 Lbs	10 kg - 22 Lbs
Shipping weight	6.5 Kg - 14.5 Lbs	7.5 Kg - 16.5 Lbs	9.5 Kg - 21 Lbs	11.5 Kg - 25 Lbs

CP354 / CP354D / CP704 / CP704D

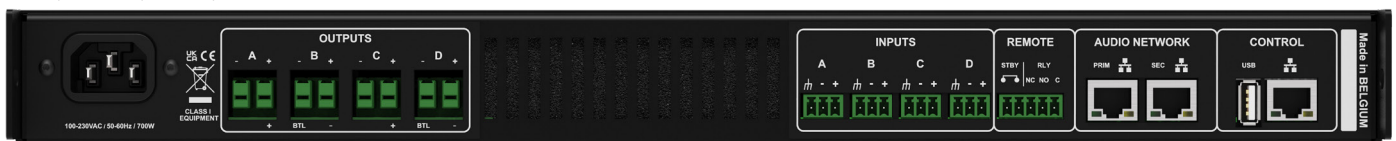

CP1504 / CP1504D / CP3004 / CP3004D

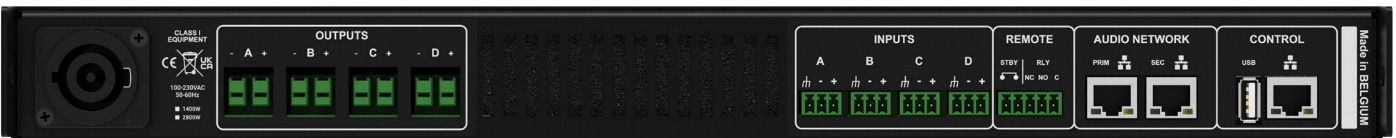

Specifications CP716D



Operating conditions

Temperature	0° to 50° C, 10 to 60 % non-condensing
Storage temperature	-20° to 70° C
Safety / Compliance	CE Certificate

Amplification and power supply

Amplification class	Class D GlidePath technology
Power supply model	Universal switch mode power supplies with active PFC
Power Factor	> 0,9 above 1/2 P
Mains Rating	100 - 240V @ 50-60 Hz
Operating Voltage	90 - 260V
AC Mains connector	Powercon 32A

Max. average power consumption (1/8)

Watts (W)	700W
Amps @ 230V	3,1
Amps @ 120V	5,9

Audio Specifications

Frequency response	1Hz - 22kHz
Distortion THD+N	0,05% @ P/2, 20Hz- 20 kHz, 22 kHz BW
Noise level (20 Hz - 20 kHz @ 8 ohm)	< 100 uV (A)
Latency	1 mS
Phase response	±10 deg 3 Hz - 20 kHz
S/N (20 Hz - 20 kHz @ 8 ohm)	118 dB (A)
Damping factor	4000@8ohm <1Khz
Input sensitivity	Settable in speaker preset. By default analog in to amplifier output = 26dB

DSP

Digital Signal Processor	64 bit fixed point
I/O Routing	Flexible routing matrix

Dante™ Audio Networking

16 Dante input channels with adjustable gain in the amplifier channel mixer
Supports 48/96kHz Dante networks
Two Gigabit network ports for the Dante network, configurable in switched or redundant mode
Supports AES67
Locate function (from Dante Controller, locate mode can be switched on to make the network port LEDs flash to locate them)



User processing functions per channel

Gain:	-80 to +15dB, 0,1dB steps
Polarity:	Normal / inverted
Delay:	0 to 250 ms (Shared between User and Group settings)
PEQ:	12 x PEQ. Each PEQ can be set to a choice of 16 filter types (1)
HP/LP filters:	Bessel , Butterworth and Linkwitz Riley with slopes from 6 to 48 dB/oct
Limiter:	Peak voltage, RMS voltage

Group processing functions

Six global processing group overlays which can link any amplifier channel in the network

Gain:	-80 to +15dB, 0,1dB steps
Polarity:	Normal / inverted
Delay:	0 to 250 ms (Shared between User and Group settings)
PEQ:	12 x PEQ. Each PEQ can be set to a choice of 16 filter types (1)

Speaker processing functions

Gain:	-80 to +15dB, 0,1dB steps
Polarity:	Normal / inverted
Delay:	0 to 250 ms (Shared between User and Group settings)
PEQ:	12 x PEQ. Each PEQ can be set to a choice of 16 filter types (1)
HP/LP filters:	Bessel , Butterworth and Linkwitz Riley with slopes from 6 to 48 dB/oct
Limiter:	Peak voltage, RMS voltage
FIR filters:	768 taps per channel
(1) Filter types:	Bell-Sym,Bell-Asym, Notch, Low-Shelf 6dB or12dB, High-Shelf 6dB or 12dB All-Pass 90° or 180°, High-Pass 6dB, or 12dB, High-Pass VariQ 12dB, Low-Pass 6dB or 12dB, Low-Pass Vari-Q 12dB, Band-Pass

Circuit protection

Mains and power supply	Under, over voltage, over current protection
Power outputs	DC, Overtemp, Overcurrent limiter, VHF
Cooling	Cooling fans with signal control speed

Inputs

Analog	4 balanced analog line inputs 4x 3-pin Phoenix
A/D conversion	32 bit
Input impedance	10 kOhm
Max. input level	21 dBu
Digital	16 x 16 Dante digital network card
Internal Streaming source	Two channel internal streaming source supporting Spotify and AirPlay

Remote control and monitoring

Network connection	Single port Ethernet interface
Apex remote control software	IntelliCloud WebUI with built-in webserver

Front panel indicators

Daylight viewable colour OLED display	Real time level , limit and fault indicators
---------------------------------------	----------------------------------------------



Amplifier model		CP716D
Total burst power (all channels driven)		11200
2 ohms (with correct limiter setup)		700
4 ohms		700
8 ohms		500
16 ohms		250
Hi-Z 70V		280
Hi-Z 100V		140
Max Output Power bridged mode		
4 ohms		1200W
8 ohms		1400W
16 ohms		1000W
Power and Thermal 115V		
Idle Power		120W
Idle Current Draw		1.2A
Idle Thermal loss		408 BTU/h
1/8 Power @ 4 Ohm Power		1600W
1/8 Power @ 4 Ohm Current Draw		14A
1/8 Power @ 4 Ohm Thermal loss		2729 BTU/h
Power and Thermal 230V		
Idle Power		120W
Idle Current Draw		0.6A
Idle Thermal loss		408 BTU/h
1/8 Power @ 4 Ohm Power		1600W
1/8 Power @ 4 Ohm Current Draw		7A
1/8 Power @ 4 Ohm Thermal loss		2560 BTU/h
Physical		
Unit Dimensions		483 x 44.5 x 415 mm
Shipping Dimensions		560 x 120 x 610mm
Unit Weight		10 kg - 22 Lbs
Shipping weight		11.5 Kg - 25 Lbs

In the interest of continuous product improvement all values specified are subject to change without notice. Please refer to the online datasheet for the latest version. It can be found on the download section of our website: <https://apex-audio.be/downloadcenter/>

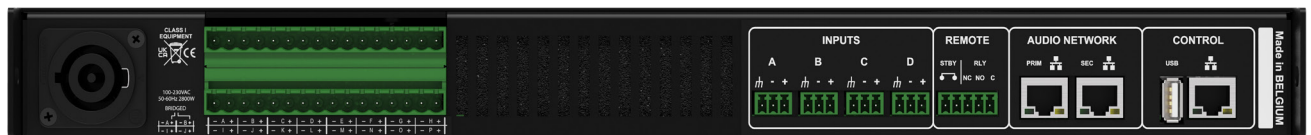

Limited Warranty

GiVa Audiovisual Technologies BV "Apex" warrants you, the original purchaser, or any party that purchases the device from you, that its products are free from defects in material and workmanship under normal use for a period of five (5) years from the date of original purchase. The date of purchase is the date which appears on the first invoice or any other proof of purchase provided by an Apex approved dealer.

Subject to the conditions and limitations set forth below, Apex will, at its discretion, either repair or replace any part of its products that prove to be defective, provided that the product is returned with proof of purchase, shipping prepaid, to an authorised Apex approved service facility.

Warranty cover of any repairs will only extend to the end of the original warranty period.

We will be happy to provide you with a list of authorised dealers to whom you can return the defective unit or who will give you a returns note to enable you to send the unit to the factory.

Service turn-around time will be as fast as reasonably possible. If you are not satisfied with the repair, contact Apex.

Exclusions and Limitations

This limited warranty covers only repair or replacement for defective products manufactured by Apex. Apex is not liable for, and does not cover under warranty, any loss of data or any costs associated with determining the source of system problems or removing, servicing or installing Apex products. This warranty excludes 3rd party software, connected equipment or stored data. Apex does not warrant that the operation of the product will be uninterrupted or error-free. In the event of a claim, Apex's sole obligation shall be replacement of the hardware.

This limited warranty does not cover:

1. any damage to this product that results from improper installation, accident, abuse, misuse, natural disaster, insufficient or excessive electrical supply, abnormal mechanical or environmental conditions or other external causes;
2. any damage caused by operating the product outside the permitted or intended uses described by Apex;
3. any damage caused by any unauthorized disassembly, repair, or modification;
4. consumable parts, such as batteries;
5. any cosmetic damage.

Apex is not liable for consequential damages.

This limited warranty also does not apply to any product on which the original identification information (including serial number) has been altered, obliterated or removed or any product that has not been handled or packaged correctly.

Warranty services will be furnished only if the product is accompanied by a copy of the original retail dealer's invoice.

Warranty claims other than those indicated above are expressly excluded.

