

VS3IP

User Guide

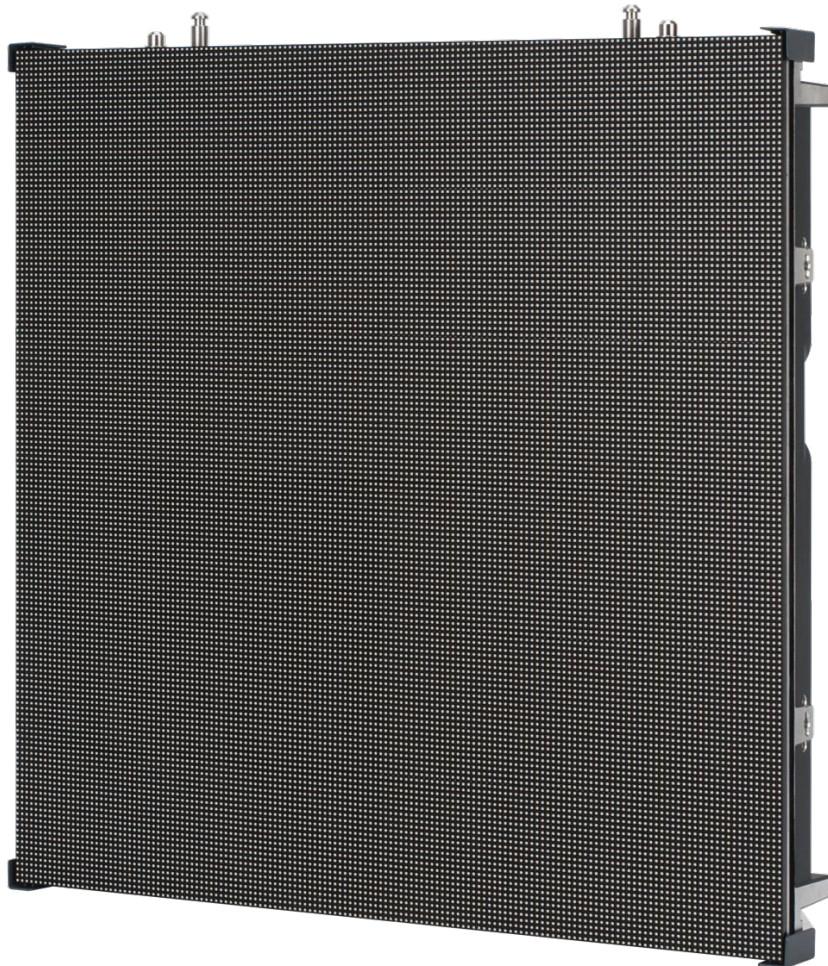

©2020 ADJ Products, LLC all rights reserved. Information, specifications, diagrams, images, and instructions herein are subject to change without notice. ADJ Products, LLC logo, and identifying product names and numbers herein are trademarks of ADJ Products, LLC. Copyright protection claimed includes all forms and matters of copyrightable materials and information now allowed by statutory or judicial law or hereinafter granted. Product names used in this document may be trademarks or registered trademarks of their respective companies and are hereby acknowledged. All non-ADJ Products, LLC brands and product names are trademarks or registered trademarks of their respective companies.

ADJ Products, LLC and all affiliated companies hereby disclaim any and all liabilities for property, equipment, building, and electrical damages, injuries to any persons, and direct or indirect economic loss associated with the use or reliance of any information contained within this document, and/or as a result of the improper, unsafe, insufficient, and negligent assembly, installation, rigging, and operation of this product.

ADJ PRODUCTS LLC USA

6122 S. Eastern Ave. Los Angeles, CA. 90040
323-582-2650 | Fax 323-532-2941 | www.adj.com | info@adj.com

ADJ SUPPLY Europe B.V

Junostraat 2 6468 EW Kerkrade, The Netherlands
+31 (0)45 546 85 00 | Fax +31 45 546 85 99 | www.adj.eu | info@americandj.eu

ADJ PRODUCTS GROUP Mexico

AV Santa Ana 30 Parque Industrial Lerma, Lerma, Mexico 52000
+52 (728) 282-7070

DOCUMENT VERSION

Please check www.adj.com for the latest revision/update of this guide

Date	Document Version	Notes
12/01/20	1.0	Initial Release

Europe Energy Saving Notice

Energy Saving Matters (EuP 2009/125/EC)

Saving electric energy is a key to help protecting the environment. Please turn off all electrical products when they are not in use. To avoid power consumption in idle mode, disconnect all electrical equipment from power when not in use. Thank you!

CONTENTS

General Information	4
Limited Warranty (USA Only)	5
Safety Guidelines	6
Maintenance Guidelines	8
Panel Overview	9
Handling and Transportation	11
Installation	13
Technical Specifications	18
Optional Components & Accessories	20

GENERAL INFORMATION

The VS3IP is a high-resolution video panel from ADJ. Each panel has a pixel pitch of 3.84mm with a configuration of a 3-in-1 RGB SMD1921 LEDs. The panel is IP65 on the front and IP54 on the back, which allows for temporary outdoor use. The brightness is 4500 NITS. The panel also features MOM (Memory On Module) technology and produces a high refresh rate of 3,840Hz. The VS3IP includes IP65 locking power in/out connections and locking RJ45 ethernet in/out connections. This panel also features a built-in Novastar A5S receiving card.

The VS3IP has four individual modules and is rear serviceable. The VS3IPFC8 flight case holds 8 VS3IP panels. The VS3IPRB1 single panel, multi-purpose rigging bar may be used to vertically hang up to 20 VS3IP panels or vertically ground stack up to 8 panels. The panel is ETL approved.

The VS3IP is a great video solution for indoor or outdoor use. ADJ offers full packages with video processors, software, cabling, rigging bars and flight cases so that you have everything you need to get up and running.

IP65 FRONT / IP54 BACK RATED PANEL

An **IP65 FRONT / IP54 BACK** rated panel is one that can be installed in a temporary outdoor wet environment and has been designed with an enclosure that effectively protects the ingress (entry) of external foreign objects such as dust and water.

The **International Protection (IP)** rating system is commonly expressed as "**IP**" (Ingress Protection) followed by two numbers (i.e. IP65) where the numbers define the degree of protection. The first digit (Foreign Bodies Protection) indicates the extent of protection against particles entering the fixture and the second digit (Water Protection) indicates the extent of protection against water entering the fixture.

An **IP65 FRONT / IP54 BACK** rated panel is one where the FRONT has been designed and tested to protect against the ingress of dust (6) and low-pressure water jets from any direction (5), and the BACK has been designed to protect against the limited ingress of dust (No Harmful Deposit - 5), and water sprayed from any direction (4).

LIMITED WARRANTY (USA ONLY)

- A. ADJ Products, LLC hereby warrants, to the original purchaser, ADJ Products, LLC products to be free of manufacturing defects in material and workmanship for a prescribed period from the date of purchase (see specific warranty period on reverse). This warranty shall be valid only if the product is purchased within the United States of America, including possessions and territories. It is the owner's responsibility to establish the date and place of purchase by acceptable evidence, at the time service is sought.
- B. For warranty service, you must obtain a Return Authorization number (RA#) before sending the product back—please contact ADJ Products, LLC Service Department at 800-322-6337. Send the product only to the ADJ Products, LLC factory. All shipping charges must be prepaid. If the requested repairs or service (including parts replacement) are within the terms of this warranty, ADJ Products, LLC will pay return shipping charges only to a designated point within the United States. If the entire instrument is sent, it must be shipped in its original package and packaging material. No accessories should be shipped with the product. If any accessories are shipped with the product, ADJ Products, LLC shall incur no liability whatsoever for loss of or damage to any such accessories, nor for the safe return thereof.
- C. This warranty is void if the product serial number and/or labels are altered or removed; if the product is modified in any manner which ADJ Products, LLC concludes, after inspection, affects the reliability of the product; if the product has been repaired or serviced by anyone other than the ADJ Products, LLC factory unless prior written authorization was issued to purchaser by ADJ Products, LLC; if the product is damaged because it was not properly maintained as set forth in the product instructions, guidelines and/or user manual.
- D. This is not a service contract, and this warranty does not include maintenance, cleaning, or periodic checkup. During the period specified above, ADJ Products, LLC will replace defective parts at its expense with new or refurbished parts, and will absorb all expenses for warranty service and repair labor by reason of defects in material or workmanship. The sole responsibility of ADJ Products, LLC under this warranty shall be limited to the repair of the product, or replacement thereof, including parts, at the sole discretion of ADJ Products, LLC. All products covered by this warranty were manufactured after August 15, 2012, and bear identifying marks to that effect.
- E. ADJ Products, LLC reserves the right to make changes in design and/or improvements upon its products without any obligation to include these changes in any products theretofore manufactured.
- F. No warranty, whether expressed or implied, is given or made with respect to any accessory supplied with products described above. Except to the extent prohibited by applicable law, all implied warranties made by ADJ Products, LLC in connection with this product, including warranties of merchantability or fitness, are limited in duration to the warranty period set forth above. And all warranties, whether expressed or implied, including warranties of merchantability or fitness, are limited in duration to the warranty period set forth above. The consumer's and/or dealer's sole remedy shall be such repair or replacement as is expressly provided above; and under no circumstances shall ADJ Product, LLC be liable for any loss and/or damage, direct and/or consequential arising out of the use of, and/or inability to use this product.
- G. This warranty is the only written warranty applicable to ADJ Products, LLC products, and supersedes all prior warranties and written descriptions of warranty terms and conditions heretofore published.

MANUFACTURER'S LIMITED WARRANTY PERIODS:

Non-LED Lighting Products = 1-Year (365 Days) (Including Special Effect Lighting, Intelligent Lighting, UV lighting, Strobes, Fog Machines, Bubble Machines, Mirror Balls, Par Cans, Trussing, Lighting Stands, Power/Data Distribution, etc. excluding LED and lamps)

Laser Products = 1-Year (365 Days) (excluding laser diodes which have a 6-Month Limited Warranty)

LED Products = 2-Year (730 Days) (excluding batteries which have a 180 Day Limited Warranty)

NOTE: 2-Year (730 Days) Limited Warranty ONLY applies to product purchased within the United States.

StarTec Series = 1-Year (365 Days) (excluding batteries which have a 180 Day Limited Warranty)

ADJ DMX Controllers = 2 Year (730 Days)

American Audio Products = 1 Year (365 Days)

CUSTOMER SUPPORT INFORMATION

Contact ADJ Service for any product related service and support needs.

Also visit forums.adj.com with questions, comments or suggestions.

ADJ SERVICE USA - Monday - Friday 8:00am to 4:30pm PST

Voice: 323-582-2650 | Fax: 323-832-2941 | support@adj.com

ADJ SERVICE EUROPE - Monday - Friday 08:30 to 17:00 CET

Voice: +31 45 546 85 60 | Fax: +31 45 546 85 96 | support@adj.eu

SAFETY GUIDELINES

This panel is a sophisticated piece of electronic equipment. To guarantee a smooth operation, it is important to follow all instructions and guidelines in this manual. ADJ is not responsible for injury and/or damages resulting from the misuse of this panel due to the disregard of the information printed in this manual. Only qualified and/or certified personnel should perform the installation of this panel and all included and/or rigging accessories. Only the original included rigging parts and/or rigging accessories for this panel should be used for proper installation. Any modifications to the panel, included and/or rigging accessories will void the original manufactures warranty and increase the risk of damage and/or personal injury.



PROTECTION CLASS 1 - PANEL MUST BE PROPERLY GROUNDED

THERE ARE NO USER SERVICEABLE PARTS INSIDE THIS PANEL.

DO NOT ATTEMPT ANY REPAIRS YOURSELF; DOING SO WILL VOID YOUR MANUFACTURES WARRANTY. DAMAGES RESULTING FROM MODIFICATIONS TO THIS PANEL AND/OR THE DISREGARD OF SAFETY INSTRUCTIONS AND GUIDELINES IN THIS MANUAL VOID THE MANUFACTURES WARRANTY AND ARE NOT SUBJECT TO ANY WARRANTY CLAIMS AND/OR REPAIRS. DO NOT PLUG PANEL INTO A DIMMER PACK! NEVER OPEN THIS PANEL WHILE IN USE! UNPLUG POWER BEFORE SERVICING PANEL! NEVER TOUCH FRONT OF PANEL DURING OPERATION, AS IT MAY BE HOT! KEEP FLAMMABLE MATERIALS AWAY FROM PANEL.



TO MAINTAIN IP RATING INTEGRITY AND PREVENT WATER FROM ENTERING PANEL, ALL UNUSED CONNECTION RUBBER CAPS MUST BE SEALED.

DO NOT touch panel housing during operation. Turn OFF power and allow approximately 15 minutes for panel to cool down before serving.

DO NOT: Operate a panel if any cover is open and/or removed.

DO NOT shake panel, avoid brute force when installing and/or operating panel.

DO NOT: Expose any part of the panel to open flame or smoke. Keep panel away from heat sources such as radiators, heat registers, stoves, or other appliances (including amplifiers) that produce heat.

DO NOT: Install/use panel in extreme hot/humid environments, or handle without ESD precautions.

DO NOT: Exceed an operation temperature of 50°C (122°F), doing so will damage the panel.

DO NOT operate panel if power cord is frayed, crimped, damaged and/or if any of the power cord connectors are damaged and do not insert into the panel securely with ease. **NEVER** force a power cord connector into the panel. If the power cord or any of its connectors are damaged, replace it immediately with a new one of similar power rating.

DO NOT block air ventilation slots/vents. All fan and air inlets must remain clean and never blocked. Allow approximately 6" (15cm) between panel and other devices or a wall for proper cooling.

ALWAYS disconnect panel from main power source before performing any type of service and/or cleaning procedure. Only handle the power cord by the plug end, never pull out the plug by tugging the wire portion of the cord.

SAFETY GUIDELINES

ONLY use the original packaging materials and/or case to transport the panel in for service.

PLEASE recycle shipping boxes and packaging whenever possible.

CAUTION: To avoid physical damage, read the installation instructions carefully before installation.

CAUTION: Panels should only be installed/operated by qualified and trained professionals **ONLY**.

CAUTION: Always mount panels in a safe and stable manner.

CAUTION: TEMPORARY OUTDOOR / WET LOCATION USE!

CAUTION: PERMANENT OUTDOOR USE / INSTALLATION WILL VOID WARRANTY!

CAUTION: Wear appropriate safety equipment during panel installation.

CAUTION: Turn OFF power to panel, computers, servers, system boxes, and monitors before making any type of power or data connections and performing any maintenance work.

CAUTION: Read user manual carefully to ensure normal operation and lifespan of the panel.

CAUTION: Electronics used in this panel are ESD (Electrostatic Discharge) sensitive. To protect device from ESD, wear a grounded ESD wrist strap or similar grounding device when handling panel.

CAUTION: Panel must be properly grounded before operating. (resistance must be less than 4Ω)

CAUTION: Ensure all power is disconnected from panel before unplugging any data cables from the panel, especially serial line ports.

CAUTION: Route power and data cables so they are NOT likely to be walked on or pinched.

CAUTION: Air conditioning is required if operating environment temperature exceeds 30°C (86°F).

CAUTION: Test panel for 2-hours per week, if not used regularly or for an extended period of time.

CAUTION: Cases used to transport panel must be properly waterproofed for transportation.

MAINTENANCE GUIDELINES

Careful and regular maintenance is necessary to optimize the potential functional lifespan of the VS3IP LED Video Panels.

1. Read the installation and operation instructions for correct operation of the VS3IP LED Video Panels.
2. Although the VS3IP LED Video Panels are designed and built to withstand some impact forces when installed correctly, take care to avoid impact damage when handling or transporting them, especially corners and edges which are particularly frangible during transportation.
3. The fixture should be serviced by a qualified service technician when:
 - A. Objects have fallen, or liquid has been spilled into the fixture.
 - B. The fixture has been exposed to rain or water conditions in excess of IP rating parameters (IP65 front / IP54 rear).
 - C. The fixture does not appear to operate normally or exhibits a marked change in performance.
 - D. The fixture has fallen and/or subjected to extreme handling.
4. Check each VS3IP LED Video Panel for loose screws and other fasteners.
5. If the VS3IP LED Video Panel installation is fixed or displayed for a lengthy time, regularly inspect all rigging and installation equipment, and replace or repair it as necessary, and during long periods of non-use, disconnect the main power to the unit.
6. Use necessary ESD (electrostatic discharge) precautions when handling VS3IP LED Video Panels, especially the LED screens, as they are ESD sensitive and easily damaged from ESD exposure.
7. The Null Line and Live Line connections from the computer and control system cannot be reversed, and should therefore only be connected in original layout order.
8. If the GFI (Ground Fault Interrupt) breaker-switch trips often, check the display or replace the power-supply switch.
9. When operating the VS3IP LED Video Panels, power the computer before powering the LED Video Screens; conversely, when shutting down after operation, turn the LED Video Panels off before turning off the computer. If the PC is turned off first, a high intensity brightness might appear, causing catastrophic failure to those LEDs.
10. If while conducting an electrical test a circuit shorts, a breaker-switch trips, wires burn, and or any other abnormality appears, discontinue testing and troubleshoot units to find the problem before continuing with any testing or operation.
11. To ensure consistent operation, it might be necessary to learn operating parameters for installation, data recovery, backup, controller settings, and basic data preset modification.
12. Regularly check computer for any viruses, and remove any irrelevant data.
13. Only a qualified technician should operate software system.
14. Remove any moisture found inside or outside of any VS3IP LED Video Panels before dismantling video installation, and returning them to their optional flight cases (sold separately). Ensure flight cases are free of any moisture, using a fan to dry them if necessary, and avoid ESD generating friction when returning VS3IP LED Video Panels.
15. Although the VS3IP LED Video Panels are designed for indoor and outdoor usage within its IP rating parameters (IP65 front / IP54 rear), limit or remove any unit exposure to moisture, condensation, or humidity, and consider using air conditioning where available.
16. When not in use, store VS3IP LED Video Panels in a dry, well ventilated facility.

PANEL OVERVIEW

Each VS3IP LED Video Panel includes a quick-release power supply with 2X data connectors, allowing for easy serviceability and simple repairs whilst out on the road. The cover of the power supply box can be secured to protect all internal accessories and components.

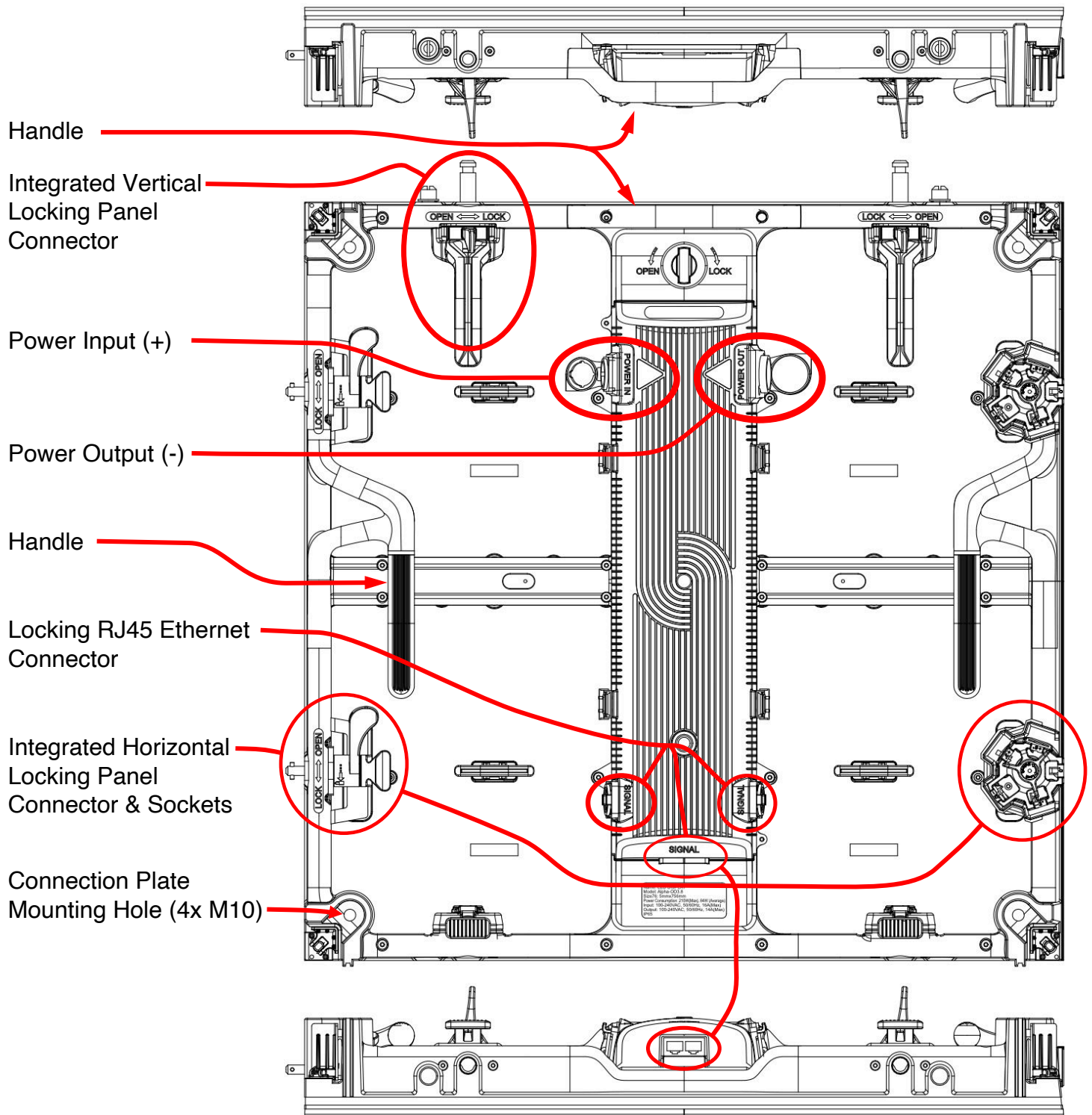

PANEL OVERVIEW

Dimensions: 22.7"x22.7"x3.0" / 576x576x75mm

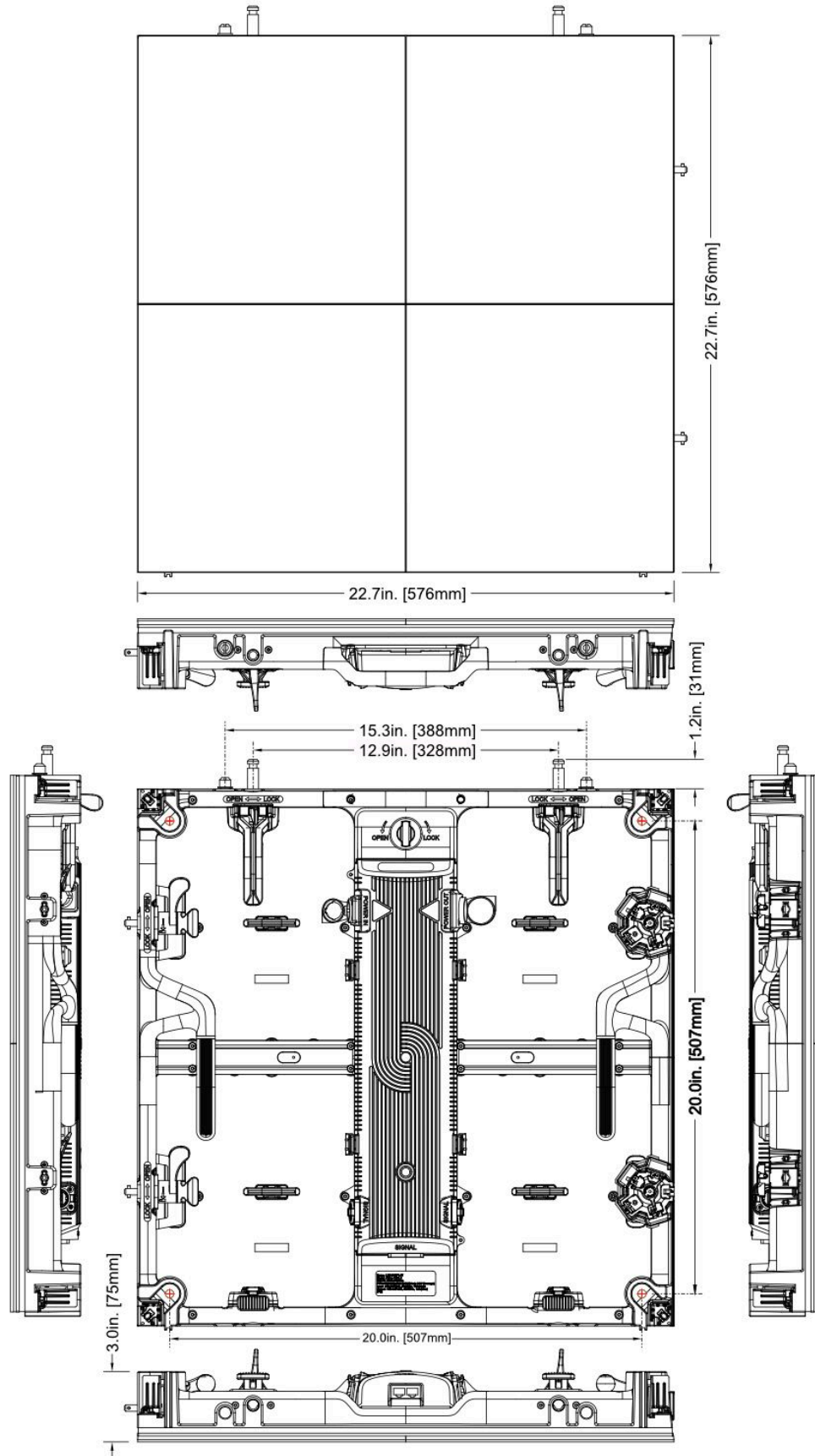

HANDLING AND TRANSPORTATION

The corners of the VS3IP LED Video Panel are susceptible to damage during handling and transportation. When removing VS3IP LED Video Panels from their respective Flight Cases (VS3IPFC sold separately), and before they are installed, take care to avoid damaging any of the 4 corners.

VS3IP LED Video Panels are susceptible to damage at corners

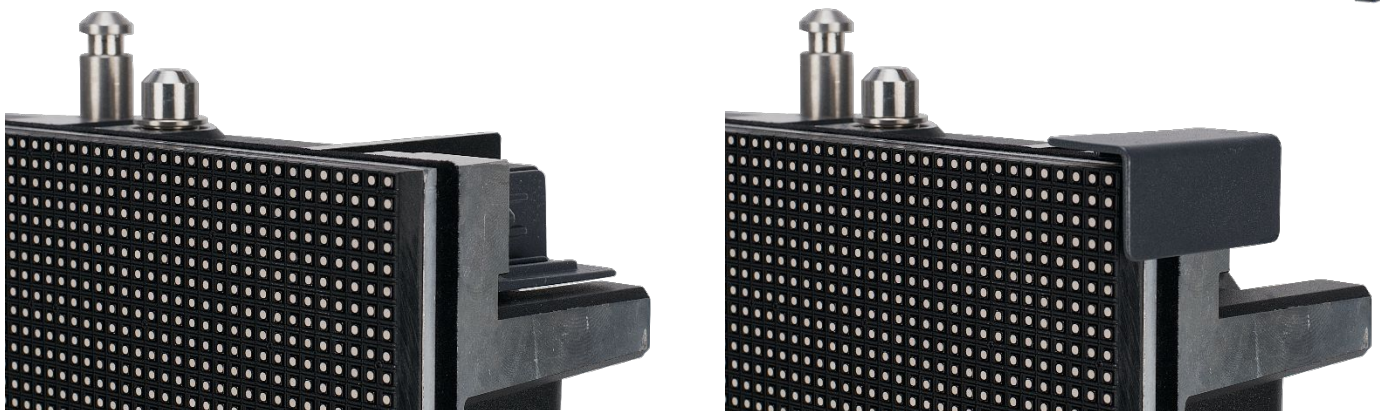
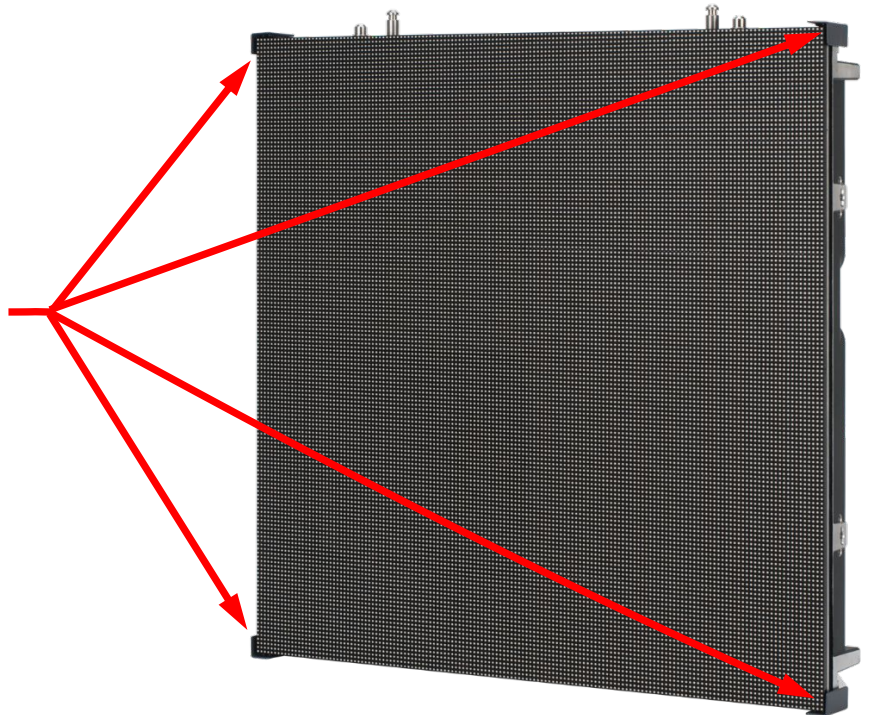

The Integrated corner protectors rotate into their respective pockets for adjacent panel installation, or out of their pockets to protect the corners during transportation or storage.

Because these are ESD sensitive units, use ESD precautions when removing the VS3IP LED Video Panels from their flight case (ESD gloves, protective clothing, wrist straps, etc.). In addition to using standard ESD precautions, to reduce static building friction, take care to lift the panels without rubbing the LED panel surface along the foam-covered slots, which can generate static electricity that can damage LEDs on VS3IP Panel.

HANDLING AND TRANSPORTATION

The optional VS3IPFC8 Flight Case (sold separately) holds 8x VS3IPs. The flight case features a full foam lining with slots for each unit. The case is robust, so will completely protect a set of panels on the road. Designed specifically for use with ADJ video panels, it is constructed from 9mm plywood and fitted with steel ball corners, aluminum edging, large swivel castors, professional butterfly latches, four sprung handles, and a hinged lid.



VS3IPFC8 Flight Case

INSTALLATION



**DO NOT INSTALL THE PANEL IF YOU ARE NOT QUALIFIED TO DO SO!
INSTALLATION BY QUALIFIED TECHNICIANS ONLY!**



**INSTALLATIONS SHOULD BE CHECKED BY A QUALIFIED PERSON ONCE A YEAR!
FLAMMABLE MATERIAL WARNING**



Keep panel minimum 5.0 feet (1.5m) away from flammable materials and/or pyrotechnics.



ELECTRICAL CONNECTIONS

A qualified electrician should be used for all electrical connections and/or installations.



**A MAXIMUM OF 15 panels may be suspended from each other vertically in a curtain.
An unlimited number of panels may be installed horizontally.
(NOTE: Additional processing may be necessary)**



**USE CAUTION WHEN POWER LINKING MULTIPLE PANELS AS THE POWER CONSUMPTION
OF OTHER PANEL MODELS MAY EXCEED THE MAX POWER OUTPUT ON THIS PANEL.
CHECK SILK SCREEN FOR MAX AMPS.**

MODEL	MAXIMUM POWER CONSUMPTION (W)	MAXIMUM AMPERES OUT (A)
VS3IP	210W	2.5A

WARNING! The safety and suitability of any lifting equipment, installation location/platform, anchoring/rigging/mounting method and hardware, and electrical installation is the sole responsibility of the installer.

Panel(s) and all panel accessories and all anchoring/rigging/mounting hardware **MUST** be installed following all local, national, and country commercial electrical and construction codes and regulations.

Before rigging/mounting a single panel or multiple interconnected panels to any metal truss/structure, a professional equipment installer **MUST** be consulted to determine if the metal truss/structure or surface is properly certified to safely hold the combined weight of the panels(s), clamps, cables, and all accessories.

Inspect metal truss/structure visually to ensure it does not flex and/or become deformed due to the weight of the panel(s). Damage caused to panel(s) by mechanical stress is not covered by warranty.

Panel(s) should be installed in areas outside walking paths, seating areas, or away from areas where unauthorized personnel might reach the panel(s) by hand. Access under work area must be blocked.

NEVER stand directly below the panel(s) when rigging, removing or servicing.

OVERHEAD RIGGING

Overhead fixture installation must always be secured with a secondary safety cable attachment, such as an appropriately rated safety cable. Overhead rigging requires extensive experience, including amongst others calculating working load limits, installation material being used, and periodic safety inspection of all installation material and the fixture. If you lack these qualifications, do not attempt the installation yourself. Improper installation can result in bodily injury and property damage.

INSTALLATION - ASSEMBLY

Horizontal Panel Assembly

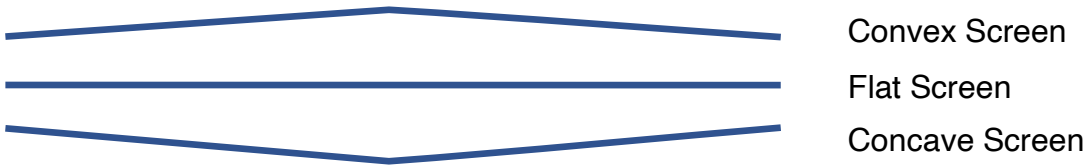

For flat, concave, and convex panel assembly, choose the desired angle from -6° to $+6^\circ$ in 3° increments (-6° , -3° , 0° , $+3^\circ$, & $+6^\circ$). Insert spring loaded tab-keyed connectors through their respective slots, then rotate their handles to hold them in place. Note the "LOCK" and "OPEN" directional arrows for the locking-handle.

INSTALLATION - ASSEMBLY

Vertical Panel Assembly

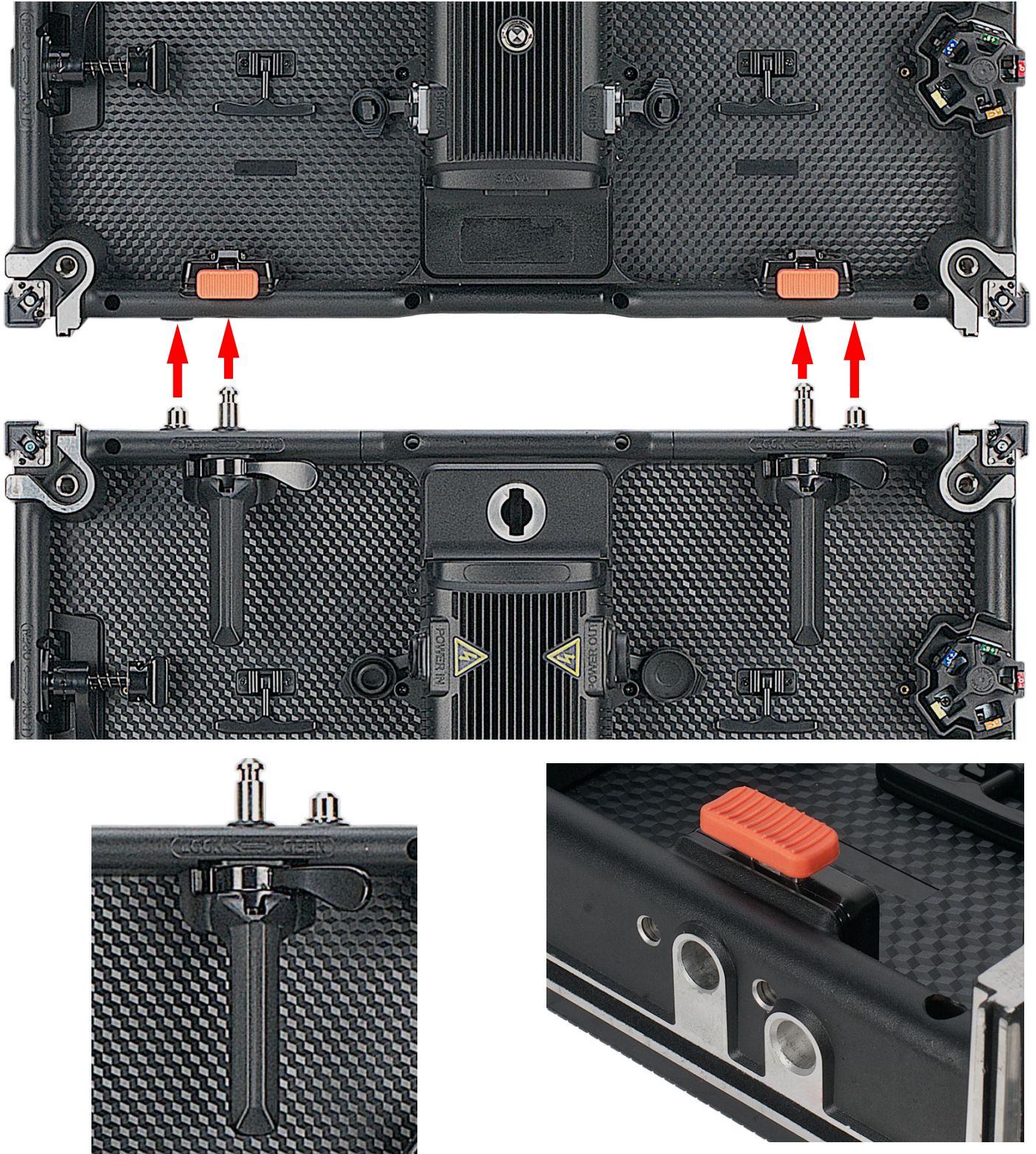

Align the vertical positional posts at the top of the panel with their corresponding alignment holes at the bottom of the higher panel, then push the locking vertical connectors up through their corresponding sockets and lock. Note the “LOCK” and “OPEN” directional arrows for the locking-handle. Activate the orange tabs to disconnect.

INSTALLATION – RIGGING BAR

The VS3IP is compatible with ADJ's VS3IPRB1 Rigging Bar (sold separately), which easily and securely locks to the top of the first panel in a vertical hang of up to 20 VS3IPs, allowing them hang from a truss, hoist, or lintel beam. A qualified technician or trained professional is required to fly the VS3IPRB1 Rigging Beam/VS3IP LED Video Panel assembly.

Align the vertical positional posts at the top of the panel with their corresponding alignment holes at the bottom of the Rigging Bar, then push the locking vertical connectors up through their corresponding sockets and lock. Note the "LOCK" and "OPEN" directional arrows for the locking-handle. Activate the orange tabs to disconnect.

VS3IPRB1 Rigging Bar



NOTE: 20 MAX. PANELS PER RIGGING BAR

INSTALLATION – FLAT PANEL ASSEMBLY

Rear Support Bracket: Use an **VS3IPRSB** Rear Support Bracket (sold separately) when connecting multiple panels for a larger display design, to strengthen the structural integrity of the screen, improve consistent flatness, and improve overall screen continuity.

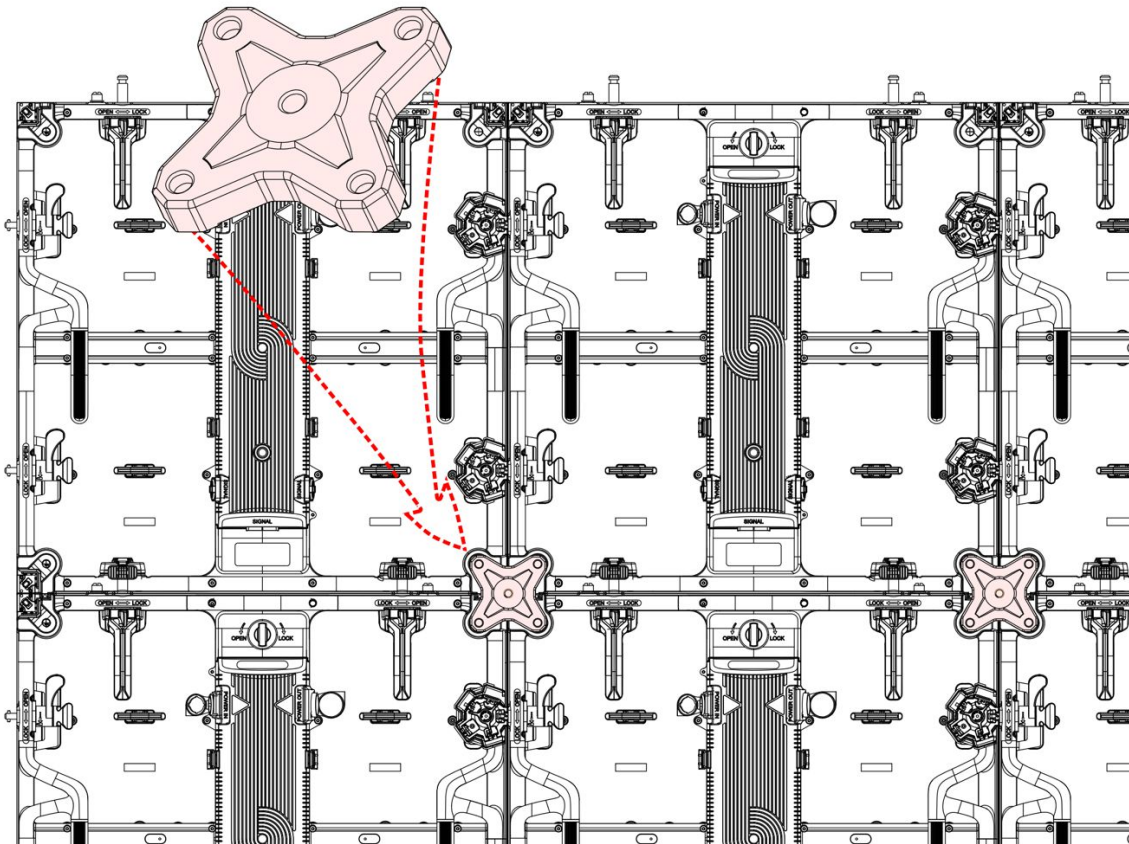
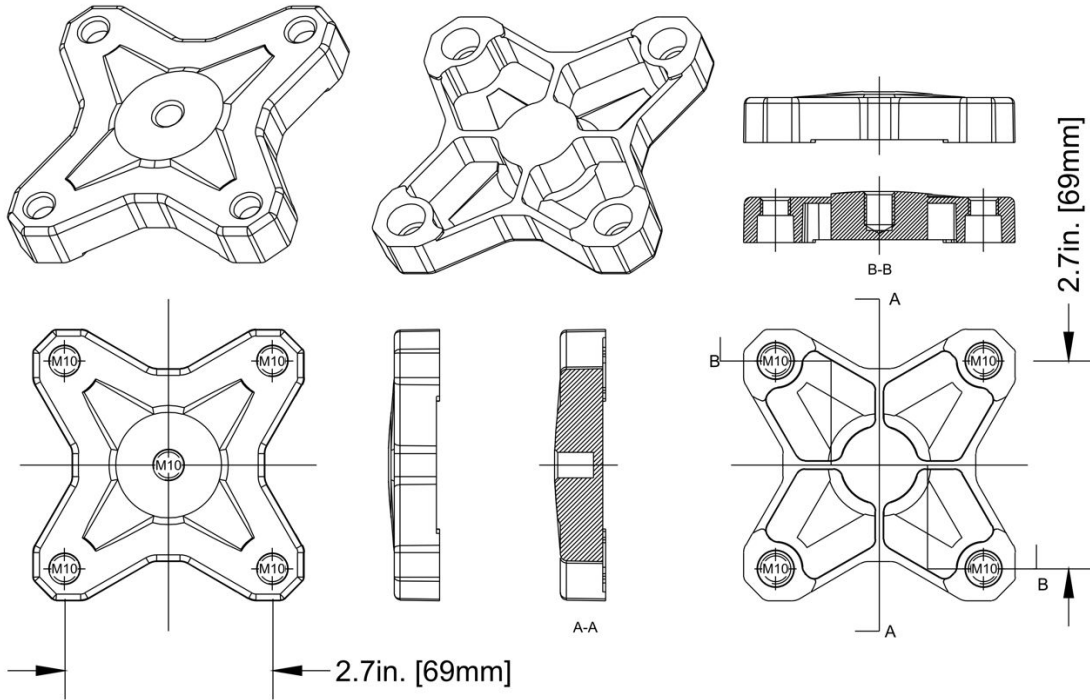

TECHNICAL SPECIFICATIONS

SPECIFICATIONS:

- Pixel Pitch: 3.84mm (0.15")
- LED Configuration: 3-in-1 SMD1921 LED
- Pixel Density: 150x150 per panel; 67816 per square meter
- Size: 22.7"x22.7"x3.00" / 576x576x75mm
- Module Quantity: 4
- Weight: 19.84 lbs. / 9kg.

FEATURES:

- IP65 Front / IP54 Back (Temporary outdoor use)
- Corner Protectors to protect the corners of the VS3IP during transport, set-up and teardown
- IP65 rated rubber capped protective connections
- 4 easy to replace video modules on each panel
- Rear carry handles
- Curve panels in convex or concave -6, -3 degrees or 0, +3, +6 degrees
- Quick lock system to connect panels together
- Quick release power supply / receiving card module
- Novastar A5S receiving card

MECHANICAL RATINGS:

- Surface Flatness: Gaps<0.5mm

OPTICAL RATINGS:

- Brightness: 4500 NITS
- View Angle: Horizontal 160°/Vertical 140° @ 9.75 ft. (3m)
- Gray Scale: ≥14-bit
- Display Color: 256
- Brightness Adjustment: 0~100% 100 Levels
- Contrast ratio: 5000:1
- Processing: 14-bit

POWER SUPPLY:

- Operation Power: 100~240V 50-60Hz
- Max. Power Consumption: 210W/per panel
- Ave. Power Consumption: 84W/per panel
- IP65 Rated Connections Power/Data: PowerLock In/Out; DataLock In/Out

CONTROL SYSTEM:

- Control Mode: Nova Star Synchronous System with Control via DVI
- Frame Update Frequency: 50-75Hz

Specifications subject to change without any prior written notice.

- Scan Mode: 1/15
- Refresh Rate: 3840Hz
- Support Input: Composite, S-Video, Component, VGA, DVI, HDMI, HD_SDI
- Control Distance: Ethernet Cable <120m or Fiber Optic>120m
- Support VGA Mode: 1024 x 768, 1280 x 1024, 1600 x 1200, 1920 x 1280
- Brightness Correction: Pixel, Module, Cabinet

ENVIRONMENTAL:

- Operating Temp / Humidity: Fahrenheit: -4° + 104° / Celsius: -20° + 40°/ 10-90% (No Condensation)
- Operating Life / MTBF: 50,000 Hours / 5,000 Hours
- Protection Level: IP65 Front / IP54 Back
- Out of Control Rate: <0.02%

OPTIONAL ACCESSORIES:

- VS3IPFC8 (VS3134): Flight Case – Fits 8 VS3IP Panels
- VS3IPRB1 (VS3111): Rigging Bar – Hang up to 20 VS3IP Video Panels vertically or ground stack up to 8
- VSRQR (VSM210): Quick Rig - Attaches and locks on to the rear of any Vision series panel so it can be fastened to a 2" pipe or truss
- VS1RSB (VS1126) Rear Support Bracket for VS Series Panels
- Novastar VX4S: Video Processor
- Novastar MCTRL-300: Video Processor
- Novastar Nova Pro HD: Video Processor
- Arkaos Media Master: Video Software
- Arkaos GrandVJ 2.0: Video Software

CABLES:

- Cabinet to Cabinet Data Link Cables (Ethernet Locking Connectors)
- Power Locking Link Cables
- Power Locking Main Power Cables

CERTIFICATIONS:

- cETLus Approved (Control #5015975)
- CE Approved
- Fcc Approved



FCC STATEMENT

This device complies with Part 15 of the FCC Rules. Operation is subject to the following two conditions: (1) this device may not cause harmful interference, and (2) this device must accept any interference received, including interference that may cause undesired operation.

FCC RADIO FREQUENCY INTERFERENCE WARNINGS & INSTRUCTIONS

This product has been tested and found to comply with the limits as per Part 15 of the FCC Rules. These limits are designed to provide reasonable protection against harmful interference in a residential installation. This device uses and can radiate radio frequency energy and, if not installed and used in accordance with the included instructions, may cause harmful interference to radio communications. However, there is no guarantee that interference will not occur in an installation. If this device does cause harmful interference to radio or television reception, which can be determined by turning the device off and on, the user is encouraged to try to correct the interference by one or more of the following methods:

- Reorient or relocate the device.
- Increase the separation between the device and the receiver.
- Connect the device to an electrical outlet on a circuit different from which the radio receiver is connected.
- Consult the dealer or an experienced radio/TV technician for help.

OPTIONAL COMPONENTS & ACCESSORIES

Model (SKU)	Description
VS3IPFC8 (VS3134)	Flight Case - fits 8 VS3IP
VS3IPRB1 (VS3111)	Rigging Bar - Holds up to 15 VS3IP vertically
VS3IPRSB (VS3149)	Rear Support Bracket
VSRQR (VSM210)	Quick Rig - Attaches and locks on to the rear of any Vision series panel so it can be fastened to a 2" pipe or truss
Novastar VX4S	Video Processor
Novastar MCTRL-300	Video Processor
Novastar NOVA PRO HD	Video Processor
Media Master Express 4	Video Software
GrandVJ 2.0	Video Software
MCT300	Novastar MCTRL-300 Video Processor
MED500	ArKaos Media Master Express Video Software
MED552	ArKaos Media Master Pro 5 (License)
MED223	ArKaos Studio Server
MED234	ArKaos Stadium Server
MED245	ArKaos 4K Server
MED212	ArKaos Stage Server Pro
MED201	ArKaos Stage Server Express
MPC010	Main Power Cables (Locking Power Connector In/Out to Edison)
MPC015 (15ft.)	
MPC025 (25ft.)	
MPC050 (50ft.)	
PLC1 (1ft.)	Panel to Panel Power Link Cables (Locking Power Connector In/Out to Locking Power Connector In/Out)
PLC3 (3ft.)	
PLC6 (6ft.)	
PLC10 (9.84ft.)	
PLC15 (15ft.)	
PLC25 (25ft.)	
CAT6PRO5 (5ft.)	Main Data Cables, Bare RJ45 to Locking RJ45 Ethernet Connect In/Out
CAT6PRO10 (9.84ft.)	
CAT6PRO15 (15ft.)	
CAT6PRO25 (25ft.)	
CAT6PRO50 (50ft.)	
CAT6PRO100 (100ft.)	
CAT6PRO150 (150ft.)	Panel to Panel Data Link Cables (Locking RJ45 Ethernet Connect In/Out to Locking RJ45 Ethernet Connect In/Out)
CAT6PRO25FC (25ft.)	
CAT6PRO50FC (50ft.)	
CAT6PRO100FC (100ft.)	

