

JOLT BAR FX2

User Manual

©2024 ADJ Products, LLC all rights reserved. Information, specifications, diagrams, images, and instructions herein are subject to change without notice. ADJ Products, LLC logo and identifying product names and numbers herein are trademarks of ADJ Products, LLC. Copyright protection claimed includes all forms and matters of copyrightable materials and information now allowed by statutory or judicial law or hereinafter granted. Product names used in this document may be trademarks or registered trademarks of their respective companies and are hereby acknowledged. All non-ADJ Products, LLC brands and product names are trademarks or registered trademarks of their respective companies.

ADJ Products, LLC and all affiliated companies hereby disclaim any and all liabilities for property, equipment, building, and electrical damages, injuries to any persons, and direct or indirect economic loss associated with the use or reliance of any information contained within this document, and/or as a result of the improper, unsafe, insufficient and negligent assembly, installation, rigging, and operation of this product.

ADJ PRODUCTS LLC World Headquarters

6122 S. Eastern Ave. | Los Angeles, CA 90040 USA

Tel: 800-322-6337 | Fax: 323-582-2941 | www.adj.com | lsupport@adj.com

ADJ Supply Europe B.V.

Junostraat 2 | 6468 EW Kerkrade | Netherlands

Tel: +31 45 546 85 00 | Fax: +31 45 546 85 99 | www.adj.eu | support@adj.eu

Europe Energy Saving Notice

Energy Saving Matters (EuP 2009/125/EC)

Saving electric energy is a key to help protecting the environment. Please turn off all electrical products when they are not in use. To avoid power consumption in idle mode, disconnect all electrical equipment from power when not in use. Thank you!

DOCUMENT VERSION



Due to additional product features and/or enhancements, an updated version of this document may be available online.

Please check www.adj.com for the latest revision/update of this manual before beginning installation and/or programming.

Date	Document Version	Software Version	DMX Channels	Notes
01/26/2024	1.0	1.0	6/9/13/16/18/32/38/43/ 64/78/112/127	Initial Release

CONTENTS

Introduction	4
Limited Warranty (USA Only)	5
Warranty Registration Features	6
Safety Guidelines	7
Overview	8
Lens Installation	9
Installation Guidelines	10
Fan Modes and Low Noise Operation	16
System Menu	17
Dimmer Modes and Curves	20
DMX Setup	21
DMX Traits	23
Color Temperature	29
Color Macro Chart	30
Remote Device Management (RDM)	31
LED Pixel Zones	32
Daisy Chain Power Linking Cleaning and Maintenance	33
Specifications	34
Dimensions	35

GENERAL INFORMATION

INTRODUCTION

Please read and understand the instructions in this manual carefully and thoroughly before attempting to operate this device. These instructions contain important safety and use information.

This product is intended for use by professionally trained personnel only, and is not suitable for private use.

Unpacking

Every device has been thoroughly tested and has been shipped in perfect operating condition. Carefully check the shipping carton for damage that may have occurred during shipping. If the carton is damaged, carefully inspect the device for damage, and be sure all accessories necessary to install and operate the device have arrived intact. In the event damage has been found or parts are missing, please contact our customer support team for further instructions. Please do not return this device to your dealer without first contacting customer support. Please do not discard the shipping carton in the trash. Please recycle whenever possible.

FOR SOFTWARE UPDATES, CONTACT ADJ CUSTOMER SUPPORT.

CUSTOMER SUPPORT

Contact ADJ Service for any product related service and support needs. Also visit forums.adj.com with questions, comments or suggestions.

ADJ SERVICE USA - Monday - Friday 8:00am to 4:30pm PST
323-582-2650 | Fax: 323-832-2941 | support@adj.com

ADJ SERVICE EUROPE - Monday - Friday 08:30 to 17:00 CET
+31 45 546 85 60 | Fax: +31 45 546 85 96 | support@adj.eu

REPLACEMENT PARTS please visit parts.adj.com



IMPORTANT NOTICE!

THERE ARE NO USER SERVICEABLE PARTS INSIDE THIS UNIT. DO NOT ATTEMPT ANY REPAIRS YOURSELF; DOING SO WILL VOID YOUR MANUFACTURER'S WARRANTY. DAMAGES RESULTING FROM MODIFICATIONS TO THIS FIXTURE AND/OR THE DISREGARD OF SAFETY INSTRUCTIONS AND GUIDELINES IN THIS MANUAL VOID THE MANUFACTURER'S WARRANTY AND ARE NOT SUBJECT TO WARRANTY CLAIMS AND/OR REPAIRS.

LIMITED WARRANTY (USA ONLY)

- A. ADJ Products, LLC hereby warrants, to the original purchaser, ADJ Products, LLC products to be free of manufacturing defects in material and workmanship for a prescribed period from the date of purchase (see specific warranty period on reverse). This warranty shall be valid only if the product is purchased within the United States of America, including possessions and territories. It is the owner's responsibility to establish the date and place of purchase by acceptable evidence, at the time service is sought.
- B. For warranty service, you must obtain a Return Authorization number (RA#) before sending back the product-please contact ADJ Products, LLC Service Department at 800-322-6337. Send the product only to the ADJ Products, LLC factory. All shipping charges must be pre-paid. If the requested repairs or service (including parts replacement) are within the terms of this warranty, ADJ Products, LLC will pay return shipping charges only to a designated point within the United States. If the entire instrument is sent, it must be shipped in its original package. No accessories should be shipped with the product. If any accessories are shipped with the product, ADJ Products, LLC shall have no liability whatsoever for loss of or damage to any such accessories, or for the safe return thereof.
- C. This warranty is void if the serial number has been altered or removed; if the product is modified in any manner which ADJ Products, LLC concludes, after inspection, affects the reliability of the product, if the product has been repaired or service by anyone other than ADJ Products, LLC factory unless prior written authorization was issued to purchaser by ADJ Products, LLC; if the product is damaged because not properly maintained as set forth in the instruction manual.
- D. This is not a service contract, and this warranty does not include maintenance, cleaning or periodic check up. During the period specified above, ADJ Products, LLC will replace defective parts at its expense with new or refurbished parts, and will absorb all expenses for warranty service and repair labor by reason of defects in material or workmanship. The sole responsibility of ADJ Products, LLC under this warranty shall be limited to the repair of the product, or replacement thereof, including parts, at the sole discretion of ADJ Products, LLC. All products covered by this warranty were manufactured after August 15, 2012, and bear identifying marks to that effect.
- E. ADJ Products, LLC reserves the right to make changes in design and/or improvements upon its products without any obligation to include these changes in any products theretofore manufactured.
- F. No warranty, whether expressed or implied, is given or made with respect to any accessory supplied with products described above. Except to the extent prohibited by applicable law, all implied warranties made by ADJ Products, LLC in connection with this product, including warranties of merchantability or fitness, are limited in duration to the warranty period set forth above. And no warranties, whether expressed or implied, including warranties of merchantability or fitness, shall apply to this product after said period has expired. The consumer's and/or Dealer's sole remedy shall be such repair or replacement as is expressly provided above; and under no circumstances shall ADJ Products, LLC be liable for any loss or damage, direct or consequential, arising out of the use of, or inability to use, this product.
- G. This warranty is the only written warranty applicable to ADJ Products, LLC Products and supersedes all prior warranties and written descriptions of warranty terms and conditions heretofore published.

LIMITED WARRANTY PERIODS

- **Non L.E.D. Lighting Products = 1-year (365 days) Limited Warranty** (Such as: Special Effect Lighting, Intelligent Lighting, UV lighting, Strobes, Fog Machines, Bubble Machines, Mirror Balls, Par Cans, Trussing, Lighting Stands etc. excluding LED and lamps)
- **Laser Products = 1 Year (365 Days) Limited Warranty** (excludes laser diodes which have 6 month limited warranty)
- **L.E.D. Products = 2-year (730 days) Limited Warranty** (excluding batteries which have a 180 day limited warranty)
Note: 2 Year Warranty only applies to purchases within the United States.
- **StarTec Series = 1 Year Limited Warranty** (excluding batteries which have a 180 day limited warranty)
- **ADJ DMX Controllers = 2 Year (730 Days) Limited Warranty**

WARRANTY REGISTRATION

The Jolt Bar FX2 carries a 2 year limited warranty. Please fill out the enclosed warranty card to validate your purchase. All returned service items, whether under warranty or not, must be freight pre-paid and accompanied by a return authorization (R.A.) number. The R.A. number must be clearly written on the outside of the return package. A brief description of the problem as well as the R.A. number must also be written down on a piece of paper included in the shipping carton. If the unit is under warranty, you must provide a copy of your proof of purchase invoice. You may obtain an R.A. number by contacting our customer support team on our customer support number. All packages returned to the service department not displaying an R.A. number on the outside of the package will be returned to the shipper.

FEATURES

The ADJ Jolt Bar FX2 features a central strip of 112 x 5-Watt cool white SMD LEDs, surrounded on both sides by a total of 448 x .5-Watt RGB color mixing SMD LEDs. This allows the same fixture to generate intense white strobing as well as colored washes and strobe effects. Both types of LED are grouped into independently controllable zones (16 white and 32 color), which means the unit can also be used to generate strobe chases and other 'eye candy' effects.

- 32 x RGB LED zones
- 16 x Cool White LED zones
- 25 built-in RGB LED Program Macros
- 9 built-in Cool White LED Program Macros
- 180 degree mounting bracket system

INCLUDED ITEMS:

- 1x Indoor, 6ft (1.83m) Power locking to Edison power cable (U.S.)
- 1x Frost Filter
- 2x Omega Receiver Brackets (Omega Clamps sold separately)

IP RATING

This device is IP20 rated. This means that the unit is protected against the intrusions of solids approximately the size of an adult finger (2.5mm) or larger, but **the unit is not protected against water or liquid intrusion of any kind.**

SAFETY GUIDELINES

THIS FIXTURE IS COMPOSED OF SOPHISTICATED ELECTRONIC COMPONENTS. TO GUARANTEE SMOOTH OPERATION, IT IS IMPORTANT TO FOLLOW ALL INSTRUCTIONS AND GUIDELINES IN THIS MANUAL. ADJ PRODUCTS, LLC IS NOT RESPONSIBLE FOR INJURY AND/OR DAMAGES RESULTING FROM THE MISUSE OF THIS FIXTURE DUE TO THE DISREGARD OF THE INFORMATION PRINTED IN THIS MANUAL. ONLY QUALIFIED AND/OR CERTIFIED PERSONNEL SHOULD PERFORM INSTALLATION OF THIS FIXTURE AND ONLY THE ORIGINAL RIGGING PARTS INCLUDED WITH THIS FIXTURE SHOULD BE USED FOR INSTALLATION. ANY MODIFICATIONS TO THE FIXTURE AND/OR THE INCLUDED MOUNTING HARDWARE WILL VOID THE ORIGINAL MANUFACTURER'S WARRANTY AND INCREASE THE RISK OF DAMAGE AND/OR PERSONAL INJURY. ONLY CERTIFIED PERSONNEL SHOULD PERFORM INSTALLATION OF THIS FIXTURE.

- PROTECTION CLASS 1 - FIXTURE MUST BE PROPERLY GROUNDED.
- THERE ARE NO USER SERVICEABLE PARTS INSIDE THIS UNIT.
- DO NOT ATTEMPT ANY REPAIRS YOURSELF; DOING SO WILL VOID YOUR MANUFACTURER'S WARRANTY. DAMAGES RESULTING FROM MODIFICATIONS TO THIS FIXTURE AND/OR THE DISREGARD OF SAFETY INSTRUCTIONS AND GUIDELINES IN THIS MANUAL VOID THE MANUFACTURER'S WARRANTY AND ARE NOT SUBJECT TO ANY WARRANTY CLAIMS AND/OR REPAIRS.
- DO NOT PLUG FIXTURE INTO A DIMMER PACK!
- NEVER OPEN THIS FIXTURE WHILE IN USE!
- UNPLUG POWER BEFORE SERVICING FIXTURE!
- NEVER TOUCH FIXTURE DURING OPERATION, AS IT MAY BE HOT!
- KEEP FLAMMABLE MATERIALS AWAY FROM FIXTURE!
- NEVER LOOK DIRECTLY INTO THE LIGHT SOURCE!
- RETINA INJURY RISK - MAY INDUCE BLINDNESS!
- SENSITIVE PERSONS MAY SUFFER AN EPILEPTIC SHOCK!
- INDOOR / DRY LOCATIONS USE ONLY!
- DO NOT EXPOSE FIXTURE TO RAIN AND MOISTURE!
- MINIMUM DISTANCE TO OBJECTS/SURFACES IS 6.6 FEET (2 METERS)
- MINIMUM DISTANCE TO FLAMMABLE MATERIALS FROM THE SURFACE IS 1.6 FEET (0.5 METER).
- DO NOT TOUCH the fixture housing during operation. Turn OFF the power and allow approximately 60 minutes for the fixture to cool down before serving.
- DO NOT shake fixture, and avoid brute force when installing and/or operating fixture.
- DO NOT operate fixture if the power cord is frayed, crimped, damaged and/or if any of the power cord connectors are damaged and do not insert into the fixture securely with ease. NEVER force a power cord connector into the fixture. If the power cord or any of its connectors are damaged, replace it immediately with a new one of the same power rating.
- DO NOT block any air ventilation slots. All fan and air inlets must remain clean and never blocked. Allow approx. 6" (15cm) between fixture and other devices or a wall for proper cooling.
- When installing fixture in a suspended environment, always use mounting hardware that is no less than M10 x 25 mm, and always install fixture with an appropriately rated safety cable.
- Always disconnect fixture from main power source before performing any type of service and/or cleaning procedure.
- Only handle the power cord by the plug end. Never pull out the plug by tugging the wire portion of the cord.
- During the initial operation of this fixture, a light smoke or smell may emit from the interior of the fixture. This is a normal process and is caused by excess paint in the interior of the casing burning off from the heat associated with the lamp and will decrease gradually over time.
- Consistent operational breaks will ensure fixture will function properly for many years.
- Only use original packaging and materials to transport the fixture in for service.

OVERVIEW

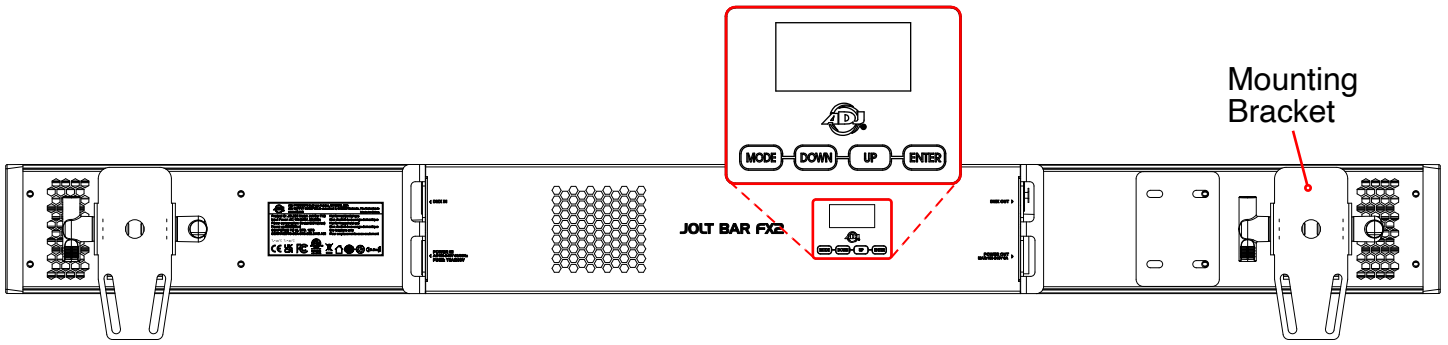

Mounting Bracket

Safety Cable Attachment Point

DMX IN

Bracket Adjustment Knob

Alignment Magnets: N

lens/Filter Lock

POWER IN
AC100-240V 50/60Hz
FUSE: T5A/250V

POWER OUT
MAX: 100-240V 8A

Alignment Magnets: S

DMX OUT

Safety Cable Attachment Point

LENS INSTALLATION

Locate Frost Filter Lens Lock and press down to unlock it. Carefully slide Frost Filter Lens into the Lens Slots. Once in place, secure the Frost Filter Lens by pressing upwards to relock it.

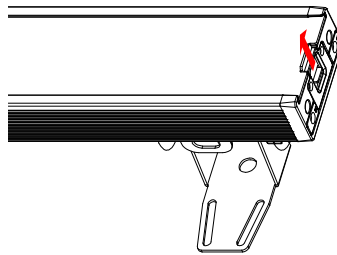
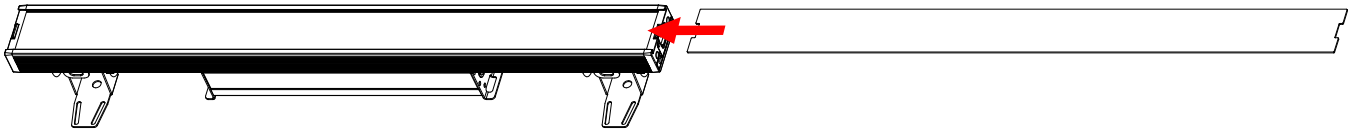
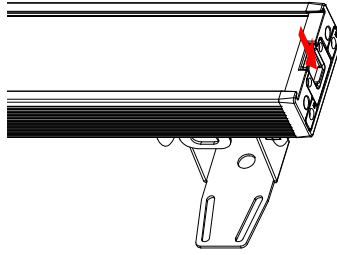

INSTALLATION



FLAMMABLE MATERIAL WARNING

Keep fixture minimum 5.0 feet (1.5m) away from flammable materials and/or pyrotechnics.



ELECTRICAL CONNECTIONS

A qualified electrician should be used for all electrical connections and/or installations.



MINIMUM DISTANCE TO OBJECTS/SURFACES IS 6.6 FEET (2 METERS).

MINIMUM DISTANCE OF INFLAMMABLE MATERIALS FROM THE SURFACE IS 1.6 FEET (0.5 METERS).

DO NOT INSTALL THE FIXTURE IF YOU ARE NOT QUALIFIED TO DO SO!

- Fixture **MUST** be installed following all local, national, and country commercial electrical and construction codes and regulations.
- Before rigging/mounting a single fixture or multiple fixtures to any metal truss/structure or placing the fixture(s) on any surface, a professional equipment installer **MUST** be consulted to determine if the metal truss/structure or surface is properly certified to safely hold the combined weight of the fixture(s), clamps, cables, and accessories.
- Maximum ambient operating temperature is **113°F (45°C)**. Do not use fixture when ambient temperature exceeds this value.
- Fixture(s) should be installed outside walking paths, seating areas, or areas where unauthorized personnel might reach the fixture by hand.
- **NEVER** stand directly below the fixture(s) when rigging, removing, or servicing.
- Overhead fixture installation must always be secured with a secondary safety attachment, such as an appropriately rated safety cable.
- Allow approximately 60 minutes for the fixture to cool down before servicing.

IP RATING

This device is IP20 rated. This means that the unit is protected against the intrusion of solids 2.5mm in size or larger (approximately the size of an adult finger tip). The unit is NOT protected against water or liquid intrusion of any kind!

RIGGING

Overhead rigging requires extensive experience, including calculating working load limits, knowledge of installation material being used, and periodic safety inspection of all installation material and the fixture, among other skills. If you lack these qualifications, do not attempt the installation yourself. Improper installation can result in bodily injury.

INSTALLATION

CLAMP INSTALLATION

This fixture features a brackets for the attachment of a mounting clamp. There is also a safety cable loop located on the heatsink rear of encased controller). When mounting the fixture to a truss or any other suspended or overhead installation, be sure to secure appropriately rated clamps (not included) to the yoke, and attach a separate SAFETY CABLE of the appropriate weight rating to the safety cable loop.

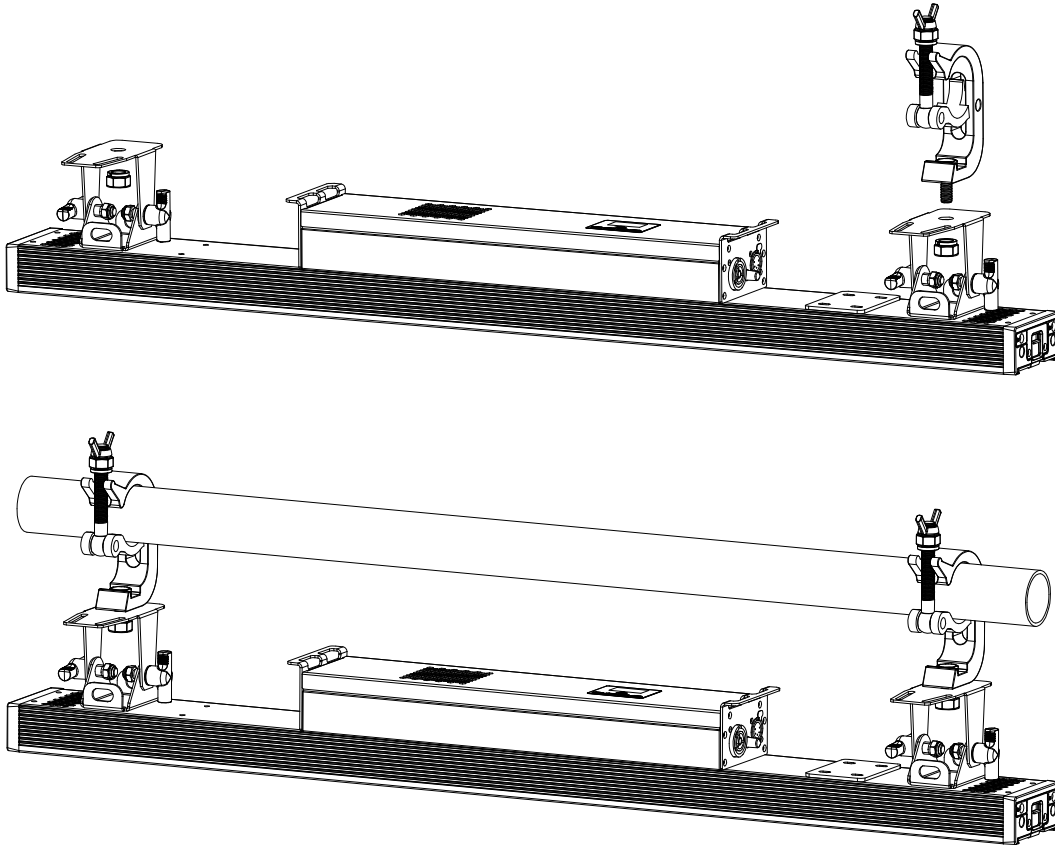

SAFETY CABLE:



ALWAYS ATTACH A SAFETY CABLE WHENEVER INSTALLING THIS FIXTURE IN A SUSPENDED ENVIRONMENT TO ENSURE THAT THE FIXTURE WILL NOT FALL IF THE CLAMPS FAIL.

INSTALLATION GUIDELINES

OMEGA BRACKETS INSTALLATION

Remove adjustable brackets and replace them with Omega Receiver Brackets. Insert the Omega Brackets into the matching holes on the Omega Receiver Brackets. Secure the Omega Brackets by turning each quick-lock fastener ¼ turn clockwise; making sure the fastener is completely locked.

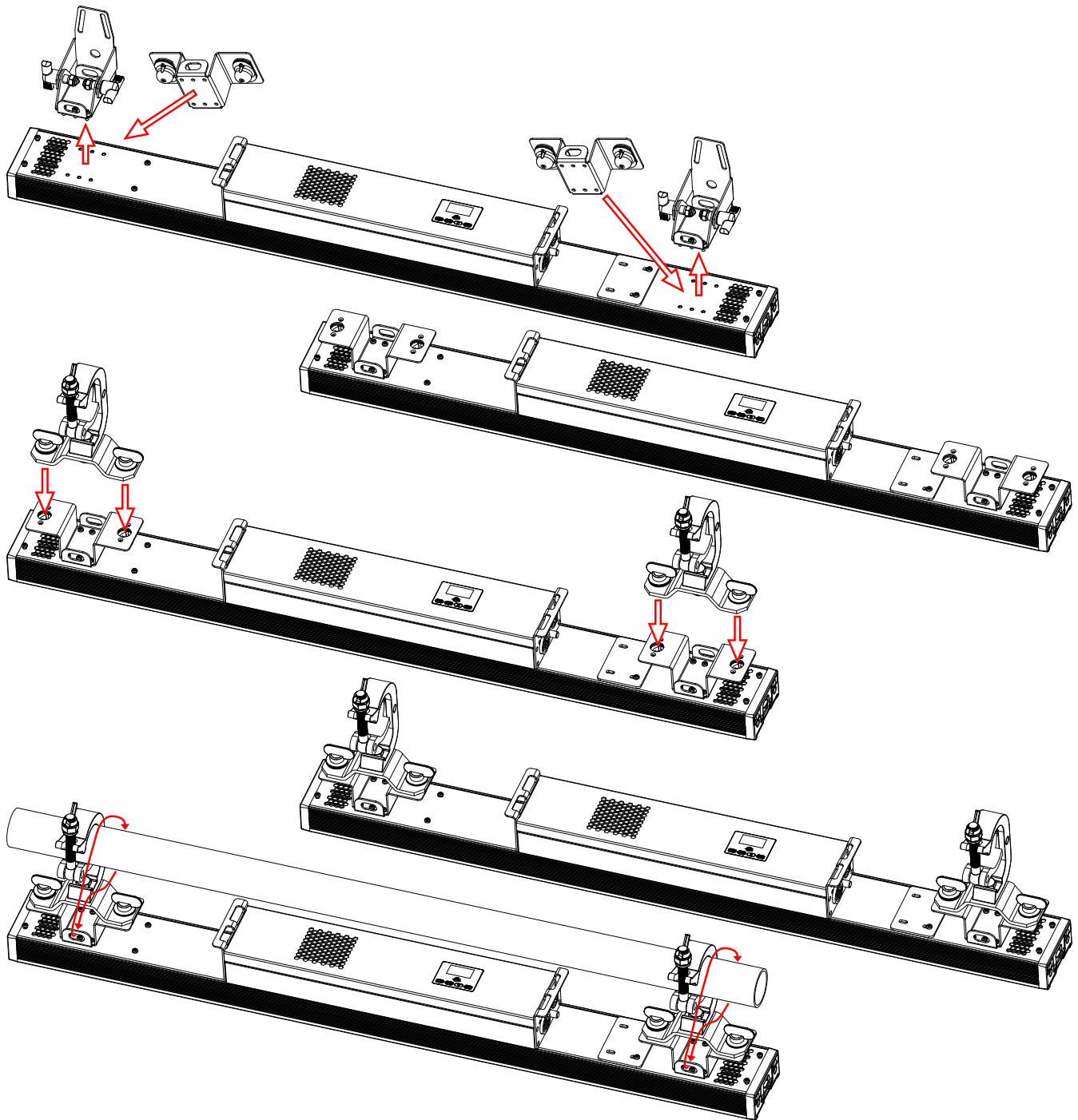

SAFETY CABLE

ALWAYS ATTACH A SAFETY WHENEVER INSTALLING THIS FIXTURE IN A SUSPENDED ENVIRONMENT TO ENSURE THE FIXTURE WILL NOT FALL IF THE CLAMP FAILS.
CLAMP INSTALLATION

When mounting fixture to truss, be sure to secure an appropriately rated professional grade rigging clamp to the included **Omega Brackets** using an M10 screw fitted through the center hole of the **Omega Brackets**. The fixture provides built-in rigging points for a **SAFETY CABLE** (not included). Be sure to only use one of the designated rigging points for the safety cable and never secure a safety cable to a carrying handle.

INSTALLATION

CONNECTOR PLATE:

Each unit includes a connector plate that can be used to secure two adjacent mounted units together. To install the connector plate, follow the directions below:

Place the connector plate across the gap between the two units, making sure to align the plate with the four (4) screw holes. Reinstall the four (4) screws that secure the connector plate in place, as well as the two (2) additional screws that held the connector plate in its storage position. The installation is now complete.

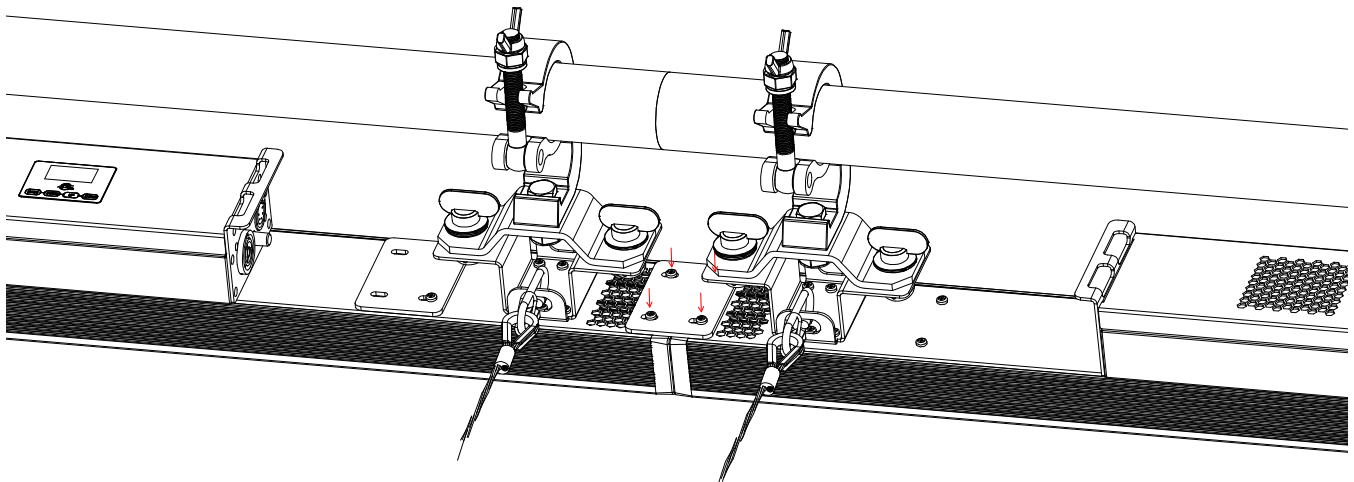
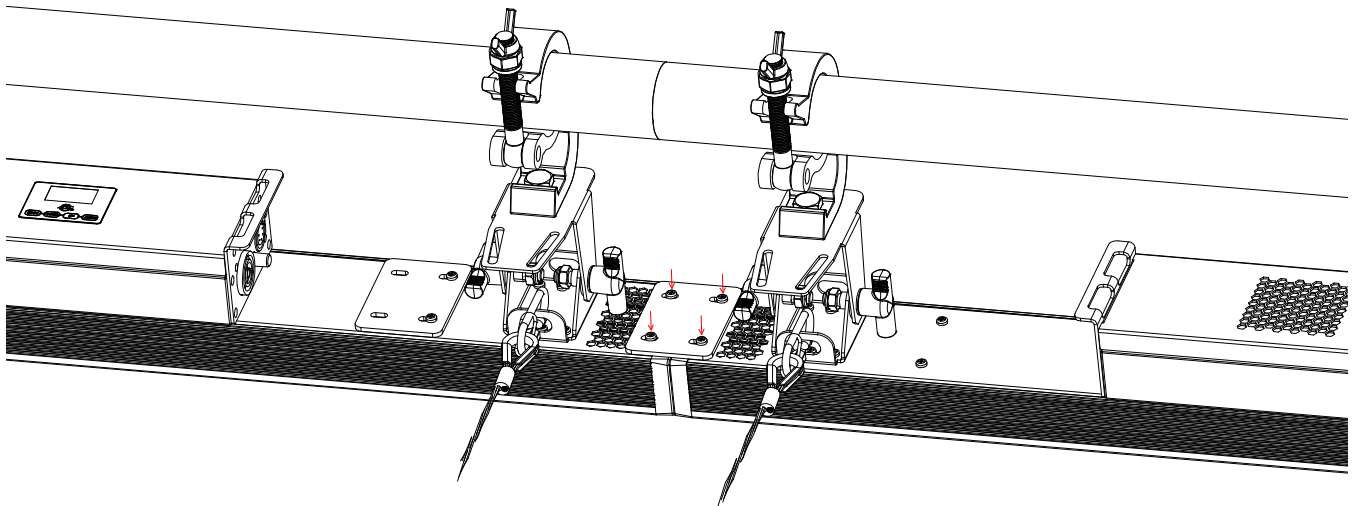

INSTALLATION GUIDELINES

RIGGING

Overhead rigging requires extensive experience, including among others, calculating working load limits, installation material being used, and periodic safety inspection of all installation material and the fixture. If you lack these qualifications, do not attempt the installation yourself. Improper installation can result in bodily injury.

This fixture is designed to be mounted vertically (hanging or upright), or horizontally (perpendicular to vertical axis) only.

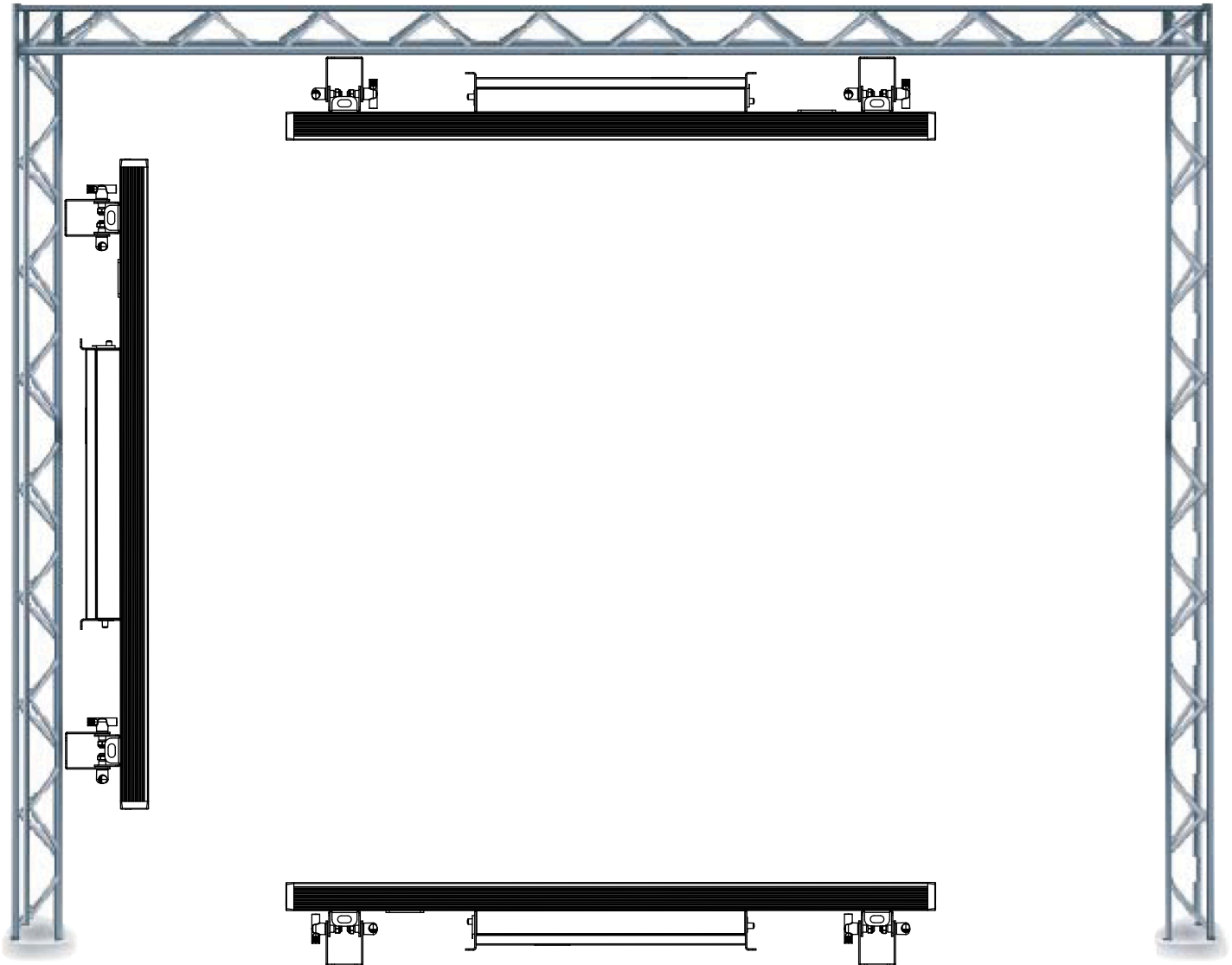

FALLING FIXTURES CAN CAUSE SEVERE INJURY OR SERIOUS EQUIPMENT DAMAGE! FOR THIS REASON, FIXTURES SHOULD BE INSTALLED AND INSPECTED ONLY BY QUALIFIED PERSONNEL. DO NOT INSTALL THE UNIT IF YOU LACK THE QUALIFICATIONS TO DO SO, OR IF YOU HAVE DOUBTS ABOUT THE SAFETY AND SECURITY OF THE INSTALLATION SETUP OR LOCATION!



ALWAYS ATTACH A SAFETY CABLE WHENEVER INSTALLING THIS FIXTURE IN A SUSPENDED ENVIRONMENT TO ENSURE THE FIXTURE WILL NOT FALL IF THE CLAMP FAILS.

INSTALLATION GUIDELINES

POTENTIAL INTERNAL FIXTURE DAMAGE FROM EXTERNAL SOURCES OF LIGHT BEAMS

External sources of light beams from direct sunlight, lighting and moving head fixtures, and lasers, which are focused directly towards the exterior housing and/or penetrate the front lens opening of Elation lighting fixtures, can cause severe internal damage including burning of optics, dichroic color filters, glass and metal gobos, prisms, animation wheels, frost filters, iris, shutters, motors, belts, wiring, discharge lamps, and LEDs.

This issue is not specific only to Elation lighting fixtures, but rather it is a common issue with lighting fixtures from all manufacturers. Although there is no true way to fully prevent this issue from happening, the guidelines below can reduce the risk of potential damage. Contact Elation Service for more details.

DO NOT EXPOSE THE FIXTURE AND/OR FRONT LENS OPENING TO LIGHT BEAMS FROM DIRECT SUNLIGHT, OTHER LIGHTING OR MOVING HEAD FIXTURES, AND LASERS DURING UNPACKING, INSTALLATION, USE, AND EXTENDED IDLE TIMES OUTDOORS. DO NOT FOCUS A LIGHT BEAM FROM ONE LIGHTING FIXTURE DIRECTLY TOWARDS ANOTHER.

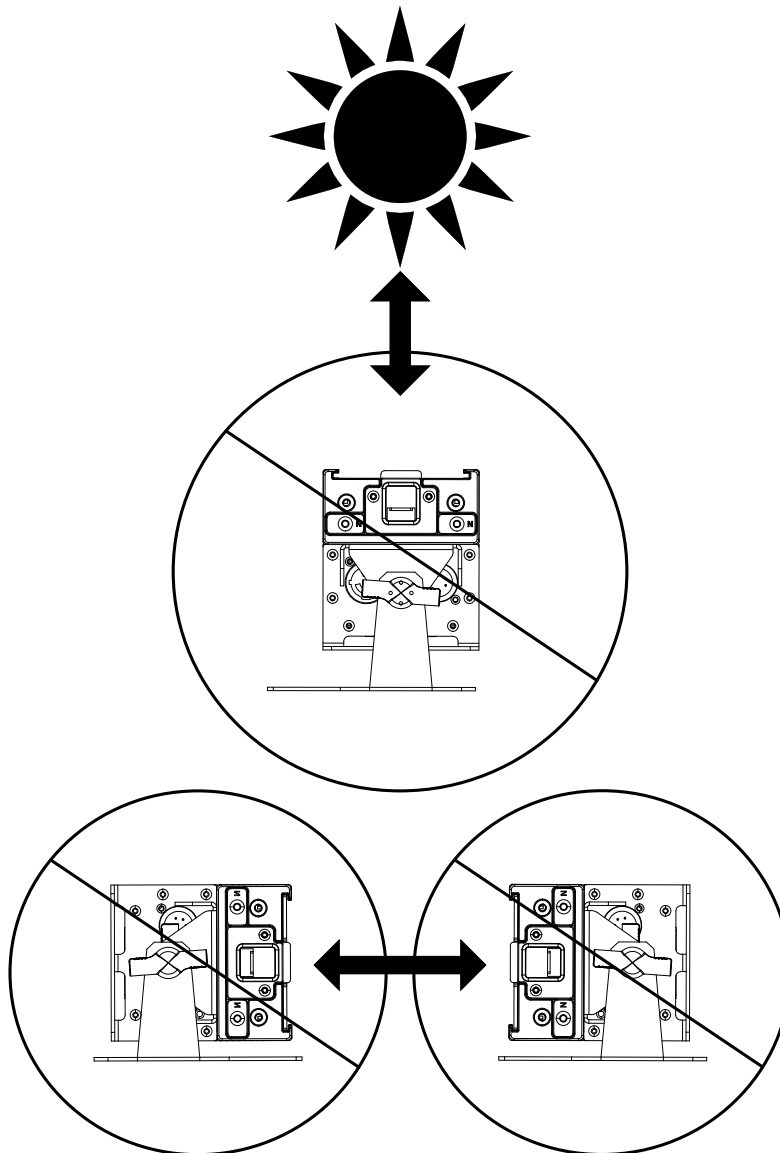

FAN MODES and LOW NOISE OPERATION

The Jolt Bar FX2 is a high-performance fixture suited for multiple applications. For noise critical environments such as Theater, Opera or Orchestra Halls, it offers various fan operation modes which remove any distraction for the audience and performers. Fan Modes can be changed remotely via the DMX control channel, allowing the fixture to offer high output or whisper silent operation at a moment's notice. All Fan Modes smoothly transition over a brief time, preventing unwanted attraction to the fixture.

Auto (Default)—Fans only run at the speeds needed to keep the LED engine within a safe temperature range and ensures optimal performance of the fixture. If possible, they will turn-off, for example, when the fixture is dimmed to a low intensity. Fans sense the ambient and fixture temperature, and will always try to keep noise levels to a minimum. The fixture output will only reduce when the LED engine cannot be cooled down to its safe operating range due to high ambient temperature.

NOTE: Recommended for daily operation.

High—Fan speeds are increased throughout for the most efficient cooling of the fixture. This mode will increase wear on the fans and should only be utilized in exceptional circumstances. Fans will always run, even if the fixture is dimmed down. Fixture output is kept at 100% unless the LED engine temperature reaches an unsafe temperature at which point the fixture will reduce power carefully to ensure continued safe operation. This mode is only required in very high ambient temperatures when automatic fan speed adjustments are not desired.

Low Noise Modes

For very critical noise environments, the fixture offers two additional Low Noise Modes for silent operation. The fixture output will be reduced, yet due to the extremely high luminous flux, the fixture still offers outstanding performance. In Low Noise Modes, all parameters of the fixture operate more quietly with reduced fan speeds.

Silent—75-80% max output, fans run at low speed.

SYSTEM MENU

The fixture includes an easy to navigate system menu control panel display where all necessary settings and adjustments are made.

- **MENU:** Leave current menu and return to previous menu level.
- **UP:** Scroll up in currently displayed menu.
- **DOWN:** Scroll down in currently displayed menu.
- **ENTER:** Select an option or confirm a selection.

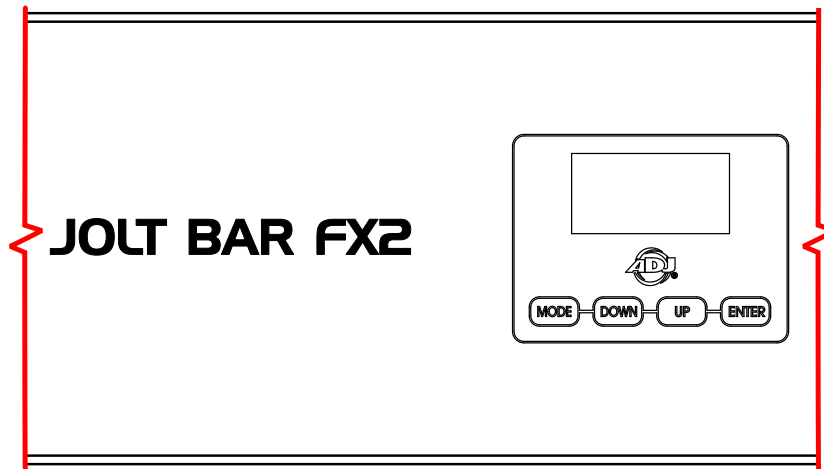

This fixture includes a display lock feature which automatically shuts off the display screen after a certain period of inactivity. This feature is OFF by default, which means that the display will always remain on regardless of inactivity, but can be configured to kick in after up to 10 minutes of inactivity. See the **System Menu** section of this manual for details on how to configure this setting.

SYSTEM MENU

MAIN MENU	OPTIONS / VALUES (Default Settings in BOLD)		DESCRIPTION	
DMX Settings	DMX Address	001 - 512		
	DMX Mode	6CH, 9CH, 13CH, 16CH, 18CH , 32CH, 38CH, 43CH, 64CH, 78CH, 112CH, 127CH		
	No DMX Status	Hold Last , Blackout, Manual		
Personality	Prim/Sec Mode	Primary, Secondary		
	Select Signal	DMX or Aria		
		Aria and DMX Out		
	Aria Settings	Aria Enable	ON/OFF	
		Set Aria Channel	00~14	
		Set Aria Band	900 Mhz.	
			2.4 Ghz.	
			Auto	
		Mesh	ON / OFF	
		RDM	ON / OFF	
	Bluetooth	ON / OFF		
	Fan Settings	Auto , High, Silent		
	Pixel Flip	On/ Off		
	Dim Modes	Standard, Stage, TV, Architectural, Theatre, Stage 2, Dim Speed		
		Dim Speed	0s-10s (Default = 0.1s)	
	Dim Cuirves	Square , Linear, Square Inverse, S-Curve		
	LED Refresh Rate	900Hz - 1500Hz (1200Hz), 2500Hz, 4000Hz, 5000Hz, 6000Hz, 10KHz, 15KHz, 20KHz, 25KHz		
	LED Power Limit	50%, 60%, 70%, 80%, 90%, 100%		
	Display	Screen Delay	Off, 10s - 5min (Default = 1 min)	
		Screen Lock	Off , 10s - 5 min	
		Rotate Display	Yes / No / Auto	
	Temperature Unit	°C/ °F	°F	
	Service	White Balance (Passcode = 011)	Red1 000 - 255	
Green1 000 - 255				
Blue1 000 - 255				
Red2 000 - 255				
Green2 000 - 255				
Blue2 000 - 255				
...				
Blue32 000 - 255				
Factory Restore	Yes / No			

SYSTEM MENU

MAIN MENU	OPTIONS / VALUES (Default Settings in BOLD)		DESCRIPTION
Manual	Red	000-255	
	Green	000-255	
	Blue	000-255	
	White	000-255	
	CCT	000-255	
	Green Shift	000-255	
	RGB Shutter	000- 255	
	RGBDimmer	000% - 100%	
	White Shutter	000- 255	
	Whited Dimmer	000% - 100%	
	Self Test	All, Dimmer, Color	
Information	On Time	Current Run Time	
		Total Run Time	
		Last Run Time	
		Reset Last Run Time	Passcode = 050
	Temperature	Current Temp xxx°	
		Max Temp 1 xxx°	
		Max Temp 2 xxx°	
		TempRst.	YES / NO
	DMX Values	Red	
		Green	
		...	
	Product IDs	RDM UID	
	Error Logs	Fixture Errors	
		Xxxxx	List Errors (Reset Passcode= 050)
		xxxxx	
		Reset Error Log	YES / NO
	Software Version	1U : V1.01B	
		2U1 : V1.01B	
		2U2 : V1.01B	

DIMMER MODES AND CURVES

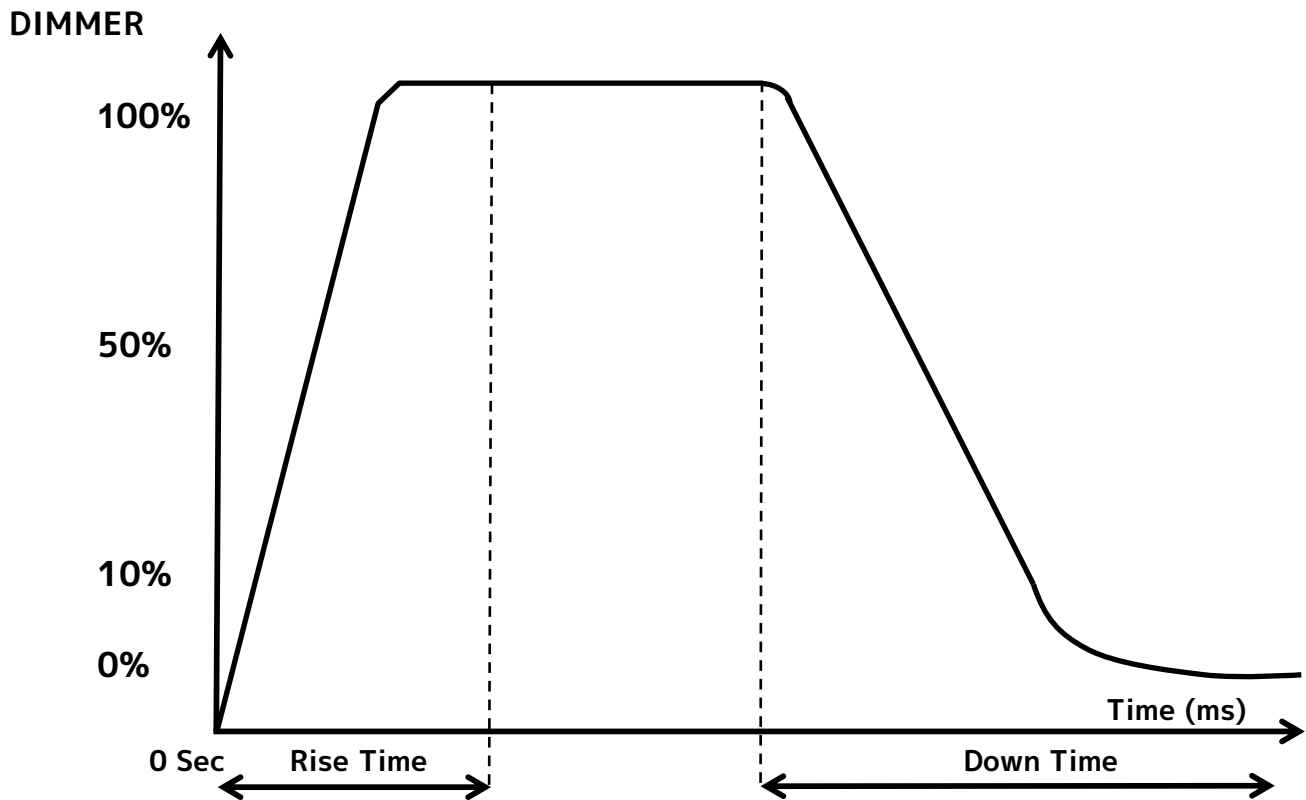

Dimming Curve Ramp Effect	0 sec Fade Time		1 sec Fade Time	
	Rise Time (ms)	Down Time (ms)	Rise Time (ms)	Down Time (ms)
Standard (default)	0	0	0	0
Stage	780	1100	1540	1660
TV	1180	1520	1860	1940
Architectural	1380	1730	2040	2120
Theatre	1580	1940	2230	2280
Stage 2	0	1100	0	1660

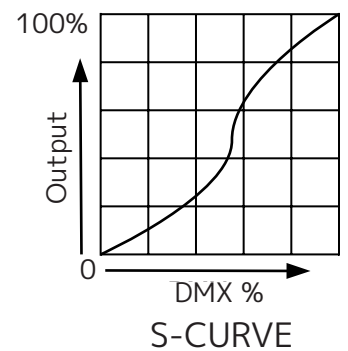
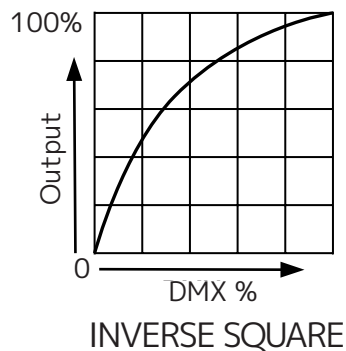
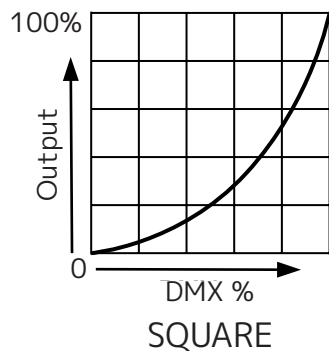
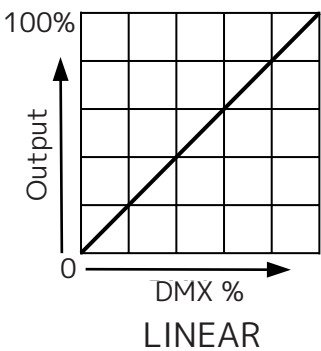

DMX SETUP

DMX-512: DMX is short for Digital Multiplex. This is a universal protocol used as a form of communication between intelligent fixtures and controllers. A DMX controller sends DMX data instructions from the controller to the fixture. DMX data is sent as serial data that travels from fixture to fixture via the DATA “IN” and DATA “OUT” XLR terminals located on all DMX fixtures (most controllers only have a DATA “OUT” terminal).

DMX Linking: DMX is a language allowing all makes and models of different manufacturers to be linked together and operate from a single controller, as long as all fixtures and the controller are DMX compliant. To ensure proper DMX data transmission, try to use the shortest cable path possible when using several DMX fixtures. The order in which fixtures are connected in a DMX line does not influence the DMX addressing. For example, a fixture assigned a DMX address of 1 may be placed anywhere in a DMX line: at the beginning, at the end, or anywhere in the middle. When a fixture is assigned a DMX address of 1, the DMX controller knows to send DATA assigned to address 1 to that unit, no matter where it is located in the DMX chain.

Data Cable (DMX Cable) Requirements (For DMX Operation):The Jolt Panel FX can be controlled via DMX-512 protocol, and features multiple DMX channel modes. Your unit and your DMX controller require a 5-pin XLR connector for data input and data output. If you are making your own cables, be sure to use standard 110-120 Ohm shielded cable (This cable may be purchased at almost all pro lighting stores). Your cables should be made with a male XLR connector at one end and a female XLR connector on the other. Also remember that DMX cable must be daisy chained and cannot be split.

Special Note: Line Termination. When longer runs of cable are used, you may need to use a terminator on the last unit to avoid erratic behavior. A terminator is a 110-120 ohm 1/4 watt resistor which is connected between pins 2 and 3 of a male XLR connector (DATA + and DATA -). This unit is inserted in the female XLR connector of the last unit in your daisy chain to terminate the line. Using a cable terminator (ADJ part number Z-DMX/T) will decrease the chances of erratic behavior.

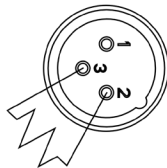
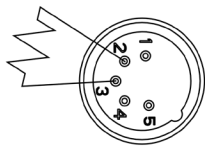

A DMX512 terminator reduces signal errors, avoiding most signal reflection interference. Connect PIN 2 (DMX-) and PIN 3 (DMX+) of the last fixture in series with a 120 Ohm, 1/4 W Resistor to terminate the DMX512.

DMX SETUP

DMX ADDRESSING

All fixtures should be given a DMX starting address when operating with a DMX controller, in order to ensure that the correct fixture responds to the correct control signal. This digital starting address is the channel number from which the fixture starts to “listen” to the digital control signal sent out from the DMX controller. The assignment of this starting DMX address is achieved by setting the correct DMX address on the digital control display on the fixture.

You can set the same starting address for all fixtures or a group of fixtures, or set different addresses for each individual fixture. Setting all fixtures to the same DMX address will cause all fixtures to react in the same way. In this case, please note that changing the settings of one channel will affect all the fixtures simultaneously.

If you set each fixture to a different DMX address, each unit will “listen” starting at the channel number you have set, based on the quantity of DMX channels of each fixture. That means changing the settings of one channel will only affect the selected fixture.

As an example, when operating this device in 6 channel mode, you should set the starting DMX address of the first unit to 1, the second unit to 7 (1 + 6), the third unit to 13 (1 + 6 + 6), and so on. (See the chart below for more details.)

Channel Mode	Unit 1 Address	Unit 2 Address	Unit 3 Address	Unit 4 Address
6 Channels	1	7	13	19
9 Channels	1	10	19	28
13 Channels	1	14	27	40
16 Channels	1	17	33	49
18 Channels	1	19	37	55
32 Channels	1	33	65	97
38 Channels	1	39	77	115
43 Channels	1	44	87	130
64 Channels	1	65	129	193
78 Channels	1	79	157	235
112 Channels	1	113	225	337
127 Channels	1	128	255	382

DMX TRAITS

CHANNEL												DMX VALUES	FUNCTION
6 CH	9 CH	13 CH	16 CH	18 CH	32 CH	38 CH	43 CH	64 CH	78 CH	112 CH	127 CH		
1	1	1		1								000-255	Outer Red , 0% - 100%
2	2	2		2								000-255	Outer Green , 0% - 100%
3	3	3		3								000-255	Outer Bkue , 0% - 100%
4	3	4										000-255	Inner White, 0% - 100%
						30	33		70			000-255	Inner White Group 1
						31	34		71			000-255	Inner White Group 2
						32	35		72			000-255	Inner White Group 3
						33	36		73			000-255	Inner White Group 4
5	5	6										000-255	Dimmer, 0% - 100%
6	6	7										000-255	Dimmer Fine, 0% - 100%
				5		25	26		65		98	000-255	Outer Dimmer, 0% - 100%
				6		26	27		66		99	000-255	Outer Dimmer Fine, 0% - 100%
													Strobe Effect
												000-002	Open
												003-005	Strobe
												006-050	Ramp up
												051-100	Ramp down
												101-150	Ramp up-down
												151-200	Lightning
												201-255	Random
	8	9										000-255	Strobe Rate ,slow to fast
	9	10										000-255	Strobe Duration ,slow to fast
		5		4			25				97	000-255	Outer Color Macros
													Outer Strobe Effect
												000-002	Open
												003-005	Strobe
				7		27	28		67		100	006-050	Ramp up
												051-100	Ramp down
												101-150	Ramp up-down
												151-200	Lightning
												201-255	Random
				8		28	29		68		101	000-255	Outer Strobe Rate,slow to fast
				9		29	30		69		102	000-255	Outer Strobe Duration,slow to fast

DMX TRAITS

CHANNEL												DMX VALUES	FUNCTION					
6 CH	9 CH	13 CH	16 CH	18 CH	32 CH	38 CH	43 CH	64 CH	78 CH	112 CH	127 CH							
																Outer Program Macro		
																000-005	No function	
																006-015	Macro 1	
																016-025	Macro 2	
																026-035	Macro 3	
																036-045	Macro 4	
																046-055	Macro 5	
																056-065	Macro 6	
																066-075	Macro 7	
																076-085	Macro 8	
																086-095	Macro 9	
																096-105	Macro 10	
																106-115	Macro 11	
		11		10			31									116-125	Macro 12	
																126-135	Macro 13	
																136-145	Macro 14	
																146-155	Macro 15	
																156-165	Macro 16	
																166-175	Macro 17	
																176-185	Macro 18	
																186-195	Macro 19	
																196-205	Macro 20	
																206-215	Macro 21	
																216-225	Macro 22	
																226-235	Macro 23	
																236-245	Macro 24	
																246-255	Macro 25	
				11			32									104	000-255	Outer Program Macro Speed
				12		34	37		74							121	000-255	Inner Dimmer, 0% - 100%
				13		35	38		75							122	000-255	Inner Dimmer Fine, 0% - 100%

DMX TRAITS

CHANNEL												DMX VALUES	FUNCTION
6 CH	9 CH	13 CH	16 CH	18 CH	32 CH	38 CH	43 CH	64 CH	78 CH	112 CH	127 CH		
				14		36	39		76		123		Inner Strobe Effect
												000-002	Open
												003-005	Strobe
												006-050	Ramp up
												051-100	Ramp down
												101-150	Ramp up-down
												151-200	lightning
												201-255	Random
				15		37	40		77		124	000-255	Inner Strobe Rate , slow to fast
				16		38	41		78		125	000-255	Inner Strobe Duration , slow to fast
													Inner Program Macro
												000-005	No function
												006-033	Macro 1
												034-060	Macro 2
												061-088	Macro 3
		12		17			42					089-116	Macro 4
												117-144	Macro 5
												145-172	Macro 6
												173-200	Macro 7
												201-228	Macro 8
												229-255	Macro 9
				18			43				127	000-255	Inner Program Macro Speed
		13										000-255	In/Out Program Macro Speed , slow to fast

DMX TRAITS

CHANNEL												DMX VALUES	FUNCTION
6 CH	9 CH	13 CH	16 CH	18 CH	32 CH	38 CH	43 CH	64 CH	78 CH	112 CH	127 CH		
			1		1	1	1	1	1	1	1	000-255	Red 1
			2		2	2	2	2	2	2	2	000-255	Green 1
			3		3	3	3	3	3	3	3	000-255	Blue 1
			4		4	4	4	4	4	4	4	000-255	Red 2
			5		5	5	5	5	5	5	5	000-255	Green 2
			6		6	6	6	6	6	6	6	000-255	Blue 2
			7		7	7	7	7	7	7	7	000-255	Red 3
			8		8	8	8	8	8	8	8	000-255	Green 3
			9		9	9	9	9	9	9	9	000-255	Blue 3
			10		10	10	10	10	10	10	10	000-255	Red 4
			11		11	11	11	11	11	11	11	000-255	Green 4
			12		12	12	12	12	12	12	12	000-255	Blue 4
					13	13	13	13	13	13	13	000-255	Red 5
					14	14	14	14	14	14	14	000-255	Green 5
					15	15	15	15	15	15	15	000-255	Blue 5
					16	16	16	16	16	16	16	000-255	Red 6
					17	17	17	17	17	17	17	000-255	Green 6
					18	18	18	18	18	18	18	000-255	Blue 6
					19	19	19	19	19	19	19	000-255	Red 7
					20	20	20	20	20	20	20	000-255	Green 7
					21	21	21	21	21	21	21	000-255	Blue 7
					22	22	22	22	22	22	22	000-255	Red 8
					23	23	23	23	23	23	23	000-255	Green 8
					24	24	24	24	24	24	24	000-255	Blue 8
								25	25	25	25	000-255	Red 9
								26	26	26	26	000-255	Green 9
								27	27	27	27	000-255	Blue 9
								28	28	28	28	000-255	Red 10
								29	29	29	29	000-255	Green 10
								30	30	30	30	000-255	Blue 10
								31	31	31	31	000-255	Red 11
								32	32	32	32	000-255	Green 11
								33	33	33	33	000-255	Blue 11
								34	34	34	34	000-255	Red 12
								35	35	35	35	000-255	Green 12
								36	36	36	36	000-255	Blue 12
								37	37	37	37	000-255	Red 13
								38	38	38	38	000-255	Green 13
								39	39	39	39	000-255	Blue 13

DMX TRAITS

CHANNEL												DMX VALUES	FUNCTION
6 CH	9 CH	13 CH	16 CH	18 CH	32 CH	38 CH	43 CH	64 CH	78 CH	112 CH	127 CH		
								40	40	40	40	000-255	Red 14
								41	41	41	41	000-255	Green 14
								42	42	42	42	000-255	Blue 14
								43	43	43	43	000-255	Red 15
								44	44	44	44	000-255	Green 15
								45	45	45	45	000-255	Blue 15
								46	46	46	46	000-255	Red 16
								47	47	47	47	000-255	Green 16
								48	48	48	48	000-255	Blue 16
										49	49	000-255	Red 17
										50	50	000-255	Green 17
										51	51	000-255	Blue 17
										52	52	000-255	Red 18
										53	53	000-255	Green 18
										54	54	000-255	Blue 18
										55	55	000-255	Red 19
										56	56	000-255	Green 19
										57	57	000-255	Blue 19
										58	58	000-255	Red 20
										59	59	000-255	Green 20
										60	60	000-255	Blue 20
										61	61	000-255	Red 21
										62	62	000-255	Green 21
										63	63	000-255	Blue 21
										64	64	000-255	Red 22
										65	65	000-255	Green 22
										66	66	000-255	Blue 22
										67	67	000-255	Red 23
										68	68	000-255	Green 23
										69	69	000-255	Blue 23
										70	70	000-255	Red 24
										71	71	000-255	Green 24
										72	72	000-255	Blue 24
										73	73	000-255	Red 25
										74	74	000-255	Green 25
										75	75	000-255	Blue 25

DMX TRAITS

CHANNEL												DMX VALUES	FUNCTION
6 CH	9 CH	13 CH	16 CH	18 CH	32 CH	38 CH	43 CH	64 CH	78 CH	112 CH	127 CH		
										76	76	000-255	Red 26
										77	77	000-255	Green 26
										78	78	000-255	Blue26
										79	79	000-255	Red 27
										80	80	000-255	Green 27
										81	81	000-255	Blue 27
										82	82	000-255	Red 28
										83	83	000-255	Green 28
										84	84	000-255	Blue 28
										85	85	000-255	Red 29
										86	86	000-255	Green 29
										87	87	000-255	Blue 29
										88	88	000-255	Red 30
										89	89	000-255	Green 30
										90	90	000-255	Blue 30
										91	91	000-255	Red 31
										92	92	000-255	Green 31
										93	93	000-255	Blue 31
										94	94	000-255	Red 32
										95	95	000-255	Green 32
										96	96	000-255	Blue 32
			13		25			49	49	97	105	000-255	White 1
			14		26			50	50	98	106	000-255	White 2
			15		27			51	51	99	107	000-255	White 3
			16		28			52	52	100	108	000-255	White 4
					29			53	53	101	109	000-255	White 5
					30			54	54	102	110	000-255	White 6
					31			55	55	103	111	000-255	White 7
					32			56	56	104	112	000-255	White 8
								57	57	105	113	000-255	White 9
								58	58	106	114	000-255	White 10
								59	59	107	115	000-255	White 11
								60	60	108	116	000-255	White 12
								61	61	109	117	000-255	White 13
								62	62	110	118	000-255	White 14
								63	63	111	119	000-255	White 15
								64	64	112	120	000-255	White 16

COLOR TEMPERATURE

DMX VALUE	COLOR TEMPERATURE (K)	DMX VALUE	COLOR TEMPERATURE (K)
23	2300	62	6200
24	2400	63	6300
25	2500	64	6400
26	2600	65	6500
27	2700	66	6600
28	2800	67	6700
29	2900	68	6800
30	3000	69	6900
31	3100	70	7000
32	3200	71	7100
33	3300	72	7200
34	3400	73	7300
35	3500	74	7400
36	3600	75	7500
37	3700	76	7600
38	3800	77	7700
39	3900	78	7800
40	4000	79	7900
41	4100	80	8000
42	4200	81	8100
43	4300	82	8200
44	4400	83	8300
45	4500	84	8400
46	4600	85	8500
47	4700	86	8600
48	4800	87	8700
49	4900	88	8800
50	5000	89	8900
51	5100	90	9000
52	5200		
53	5300		
54	5400		
55	5500		
56	5600		
57	5700		
58	5800		
59	5900		
60	6000		
61	6100		

COLOR MACRO CHART

Macro Nmnber	DMX VALUE
No Function	000-009
Color1	010-017
Color2	018-024
Color3	025-032
Color4	033-039
Color5	040-047
Color6	048-054
Color7	055-061
Color8	062-069
Color9	070-076
Color10	077-084
Color11	085-091
Color12	092-099
Color13	100-106
Color14	107-113
Color15	114-121
Color16	122-128
Color17	129-136
Color18	137-143
Color19	144-151
Color20	152-158
Color21	159-165
Color22	166-173
Color23	174-180
Color24	181-188
Color25	189-195
Color26	196-203
Color27	204-210
Color28	211-217
Color29	218-225
Color30	226-232
Color31	233-240
Color32	241-247
Color33	248-255

REMOTE DEVICE MANAGEMENT (RDM)

NOTE: for RDM to work properly, RDM enabled equipment must be used throughout the entire system, including DMX data splitters and wireless systems.

Remote Device Management (RDM) is a protocol that sits on top of the DMX512 data standard for lighting, allowing the DMX systems of the fixtures to be modified and monitored remotely. This protocol is ideal for instances in which a unit is installed in a location that is not easily accessible.

With RDM, the DMX512 system becomes bi-directional, allowing a compatible RDM enabled controller to send out a signal to devices on the wire, as well as allowing the fixture to respond (known as a GET command). The controller can then use its SET command to modify settings that would typically have to be changed or viewed directly via the unit's display screen, including the DMX Address, DMX Channel Mode, and Temperature Sensors.

FIXTURE RDM INFORMATION:

RDM Code	Device ID	Device Model ID	Personality ID
1900	0000-FFFF	40	6CH, 9CH, 13CH, 16CH, 18CH, 32CH, 38CH, 43CH, 64CH, 78CH, 112CH, 127CHLK

Please be aware that not all RDM devices support all RDM features, and therefore it is important to check beforehand to ensure that the equipment that you are considering includes all of the features that you require.

The following parameters are accessible in RDM on this device:

Parameter ID	Code
Sensor Definition	[0x0200]
Sensor Value	[0x0201]
Device Model Description	[0x0080]
Manufacturer Label	[0x0081]
Device Label	[0x0082]
DMX Personality	[0x00E0]
DMX Personality Description	[0x00E1]
Device Hours	[0x0400]
Comms Status	[0x0015]
Status ID Description	[0x0031]
Clear Status ID	[0x0032]
Device Power Cycles	[0x0405]
Display Invert	[0x0500]
Display Level	[0x0501]
Realtime Clock	[0x0603]
Power State	[0x1010]
Preset Playback	[0x1031]
Default Slot Value	[0x0122]
Language	[0x00B0]
Language Capabilities	[0x00A0]
Boot Software Version Label	[0x00C2]
Boot Software Version ID	[0x00C1]
Product Detail ID List	[0x0070]
Status Messages	[0x0030]
Proxied Devices	[0x0010]

LED PIXEL ZONES

6CH, 9CH, 13CH, AND 18CH MODES

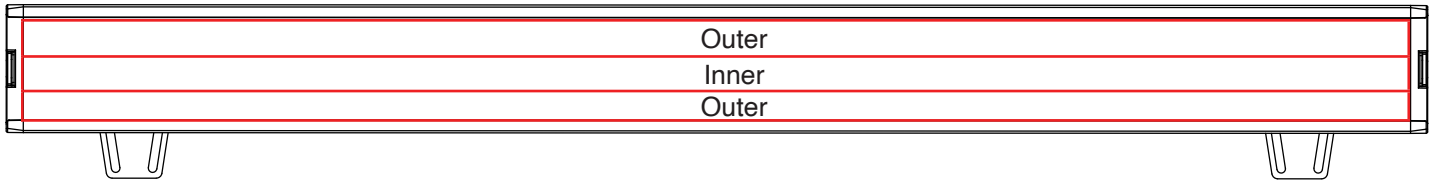

16CH MODE

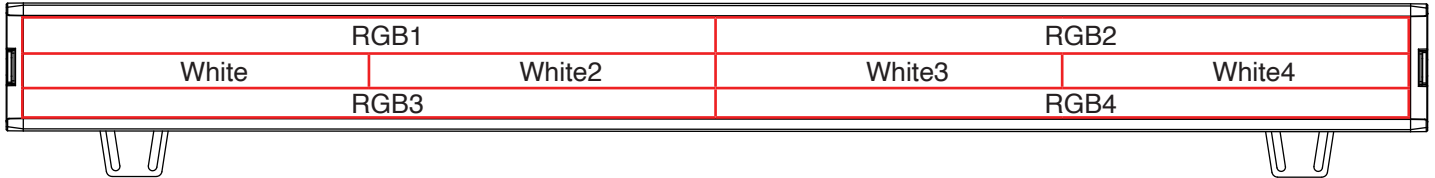

32CH MODE

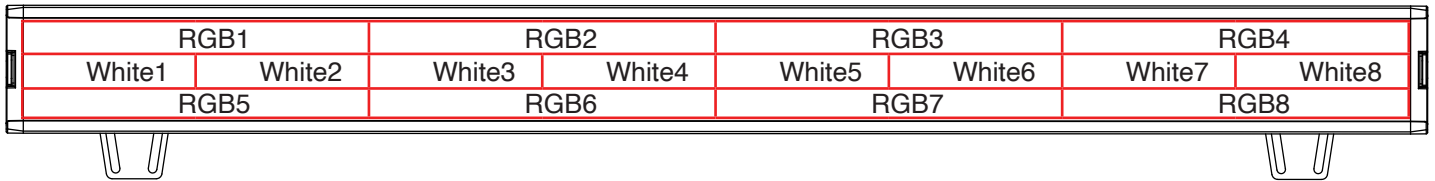

38CH, 43CH MODES

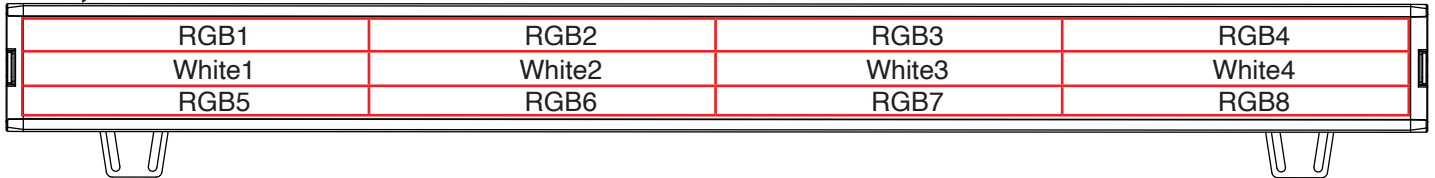

64CH, 78CH MODES

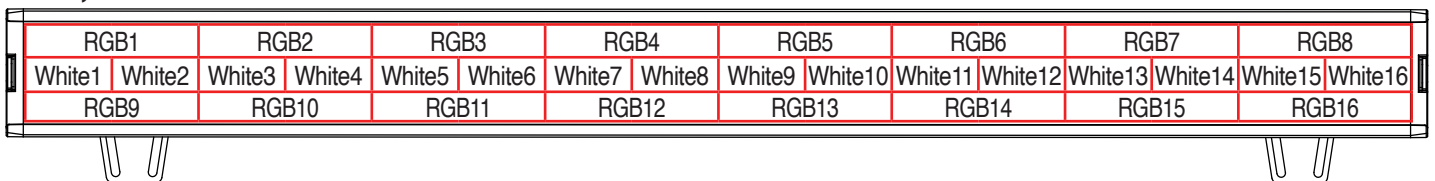

78CH, WHITE GROUP 1-4

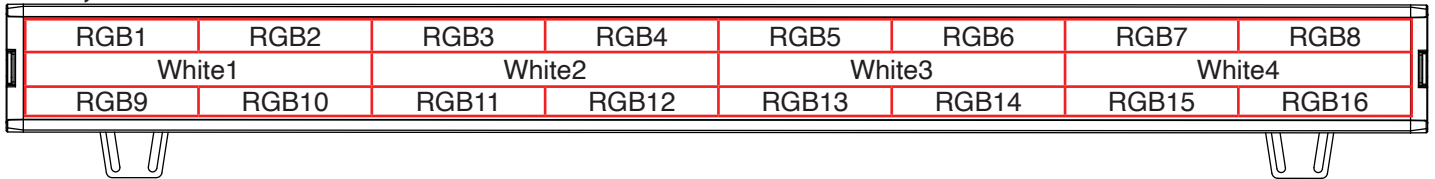

112CH, 127CH MODES



DAISY CHAIN POWER LINKING

These units have the capability to be daisy chained together via the power in/out ports. **The maximum number of units that can be linked together in this manner is as follows:**

- 4 units maximum when running on 120V power.
- 8 units maximum when running on 230V power.

DO NOT EXCEED THE NUMBER OF UNITS LISTED ABOVE.

DO NOT MIX MAKE AND MODEL TYPES WHEN DAISY CHAINING! All units that are connected in this manner must be of the same make and model type.

CLEANING AND MAINTENANCE



DISCONNECT POWER BEFORE PERFORMING ANY MAINTENANCE!

CLEANING

Frequent cleaning is recommended to ensure proper function, optimized light output, and an extended life. The frequency of cleaning depends on the environment in which the fixture operates: damp, smoky, or particularly dirty environments can cause greater accumulation of dirt on the fixture's optics. Clean the external lens surface periodically with a soft cloth to avoid dirt/debris accumulation.

NEVER use alcohol, solvents, or ammonia-based cleaners.

MAINTENANCE

Regular inspections are recommended to ensure proper function and extended life. There are no user serviceable parts inside this fixture. Please refer all other service issues to an authorized ADJ service technician. Should you need any spare parts, please order genuine parts from your local ADJ dealer.

Please refer to the following points during routine inspections:

- A detailed electrical check by an approved electrical engineer every three months, to make sure the circuit contacts are in good condition and prevent overheating.
- Be sure all screws and fasteners are securely tightened at all times. Loose screws may fall out during normal operation, resulting in damage or injury as larger parts could fall.
- Check for any deformations on the housing, color lenses, rigging hardware, and rigging points (ceiling, suspension, trussing). Deformations in the housing could allow for dust or liquids to enter into the fixture. Damaged rigging points or unsecured rigging could cause fixture to fall and seriously injure a person(s).
- Electric power supply cables must not show any damage, material fatigue, or sediments.

NEVER remove the ground prong from the power cable.

SPECIFICATIONS

Light Source:

- 448 x 0.5W RGB SMD LEDs + 112 x 5W Cool White SMD LEDs
- 78° Beam Angle
- 117° Field Angle
- Color Temperature: Red: 620-630nm. Green: 515-525nm. Blue: 460-470nm. / Cool White: 6900-7400K
- CRI: 89
- 50,000 Hour Average LED Life

Features:

- 32 x RGB LED zones
- 16 x Cool White LED zones
- 25 built-in RGB LED Program Macros
- 9 built-in Cool White LED Program Macros
- 180 degree mounting bracket system

Control:

- Control Protocol: DMX, Aria X2 and RDM
- 12 DMX Modes: 6, 9, 13, 16, 18, 32, 38, 43, 64,78, 112, and 127 channels
- Dim Modes: 6 Presets (Standard, Stage, TV, Architectural, Theatre & Stage 2)
- Dim Curves: 4 Presets (Linear, Square Law, Inv Square Law and S Curve)
- 0-100% Smooth Dimming
- Strobe, shutter & pulse control
- Max Strobe Rate 25Hz. Min Strobe Rate: 0.35Hz.
- With Wired Digital Communication Network
- Display: OLED display with 4-button touch menu

Connections:

- Data: Indoor locking 5-pin DMX In/Out
- Power: Indoor locking power In/Out

Electrical:

- 100-240V 50Hz/60Hz (Auto Sensing)
- Max Power Consumption: 214W @120V, 208W @230V
- •Max Power Link: 6pcs @120V, 12pcs @230V +
- •Fuse Protected: T5A/250V Glass Fuse (5*20MM)

Dimensions / Weight:

- Length: 4.07" (103.5mm)
- Width: 39.4" (1000mm)
- Height: 3.98" (101mm)
- Weight: TBA lbs. (TBA kg)

What's Included:

- 1x Indoor, 6ft (1.83m) Power locking to Edison power cable (U.S.)
- 1x Frost Filter
- 2x Omega Receiver Brackets (Omega Clamps sold separately)

Optional Accessories:

- 180mm Omega Bracket

Approvals and Ratings:

CE, cETLus (Pending), IP20

DIMENSIONS

Dimensions are not drawn to scale.

